

Direct Sampling SDR transceiver

MB1

HF/50 MHz/VHF TRANSCEIVER

USER MANUAL

1. READ IT FIRST	8
1.1 Congratulations	8
1.2 Features	8
1.3 Supplied accessories	10
1.4 Precautions	11
1.5 Software license agreement	13
1.5.1 ExpertSDR2 Software License Agreement	13
1.5.2 Windows 10 Software License Agreement	13
1.5.3 Other Software License Agreement	14
1.6 Copyrights	15
1.7 Contacts	15
2. CONNECTIONS	16
2.1 Antenna	16
2.2 Grounding	16
2.3 AC power	16
2.4 Front Panel accessories	17
2.4.1 Microphone(Dynamic/Electret)	17
2.4.2 Headphones	18
2.4.3 USB devices	18
2.5 Rear Panel	19
2.5.1 Accessories	19
2.5.2 External PC	20
2.5.3 External Linear Amplifier	21
2.5.4 External Control devices	22
2.5.5 Reference input	23
2.5.6 XVTR	24
2.5.7 DAC OUT low power output	25
2.5.8 RX IN and RX OUT	25
2.6 Connectors pin-out	26
2.6.1 MIC1	26
2.6.2 MIC2	26
2.6.3 COM	27
2.6.4 EXT CTRL	27
2.6.5 PA PTT Outputs	29
3. FRONT PANEL DESCRIPTION	30
4. REAR PANEL DESCRIPTION	42
5. MAIN SCREEN DESCRIPTION	47
5.1 MB1 GUI	47
5.1.1 Section 1	47
5.1.2 Section 2	48

5.1.3	Section 3	49
5.1.4	Section 4	52
5.1.5	Section 5	53
5.1.6	Section 6	53
5.1.7	Section 7	53
5.1.8	Section 8	54
5.1.9	Section 9	54
5.2	Local panels	54
5.2.1	ATU	54
5.2.2	DSP SETTINGS	56
5.2.3	FRONT END SETTINGS	57
5.2.4	Manual frequency input	59
5.2.5	MEMORY PANEL	59
5.2.6	MIC/CW SETTINGS	60
5.2.7	MIXER	62
5.2.8	NFM-SETTINGS	63
5.2.9	PROFILES	64
5.2.10	RX EQUALIZER	64
5.2.11	VOX/COMPRESSOR SETTINGS	65
5.3	Desktop GUI	66
5.3.1	Global controls panel	66
5.3.2	Software transceiver settings	71
5.3.2.1	Transceiver control panel	71
5.3.2.2	Frequency and S-meter indicators	86
5.3.2.3	DSP control panel	88
5.3.2.4	Panorama description	91
5.3.2.4.1	Spectrum Scope	91
5.3.2.4.1.1	Spectrum Scope scaling	91
5.3.2.4.2	Waterfall	93
5.3.3	Status bar	93
5.4	Options	93
5.4.1	Device menu	94
5.4.1.1	Mic	95
5.4.1.2	VAC	95
5.4.1.3	VOX	96
5.4.1.4	DSP	96
5.4.1.5	TX	100
5.4.1.6	CW	101
5.4.1.7	Ext Ctrl	102
5.4.1.8	PA	103
5.4.1.9	Expert	104
5.4.2	Sound card menu	107
5.4.2.1	Sound card	107
5.4.2.2	Line output	108
5.4.3	Display menu	109
5.4.3.1	Main window	109
5.4.3.2	Spectrum	110
5.4.3.3	Waterfall	113
5.4.3.4	Grid	114

5.4.3.5	Filter	114
5.4.3.6	Background	115
5.4.3.7	Indicators	116
5.4.4	CAT menu	117
5.4.4.1	ECATv1	117
5.4.4.2	OmniRig	119
5.5	Panel menu	120
5.6	Features menu	125
5.7	ExpertSync menu	126
5.8	CW Skimmer menu	127
5.9	Shortcuts menu	128
5.10	IQ Recorder menu	129
5.11	TCI menu	130
5.12	Spot settings menu	131
5.13	MB1 Utility	132
5.13.1	Main	132
5.13.2	Sensors	133
5.13.3	Temperature	134
5.13.4	Fan Speed	134
5.13.5	About	135
5.14	Windows settings	136
5.14.1	Date and time settings	136
5.14.2	Switch off screen saver	137
5.14.3	Switch off sleep mode	139
5.14.4	Network adapter settings	141
5.14.5	System recovery	144
5.14.5.1	Create restore point	144
5.14.5.2	Use restore point	150
5.14.6	Windows password	157
5.14.6.1	Enable Windows password	158
5.14.6.2	Disable Windows password	160
6.	TECHNICAL CHARACTERISTICS	164
6.1	Receiver	164
6.2	Transmitter	165
6.3	Internal PC	165
6.4	Other	166
7.	TRANSCEIVER OPERATIONS	167
7.1	Turning ON/OFF the transceiver	167
7.2	Frequency Tuning	167
7.3	Adjusting the AF gain	169
7.4	Adjusting the RF gain	170
7.5	Muting the received audio	170

7.6	Internal speaker On/Off	171
7.7	Using the Band Memory	171
7.8	Selecting the Operating Modes	172
7.9	ATT/PREAMP control	174
7.10	Selecting AGC presets	175
7.11	Frequency Tuning Lock	176
7.12	VFOA and VFOB control	176
7.13	Changing RX Filter width by knob	178
7.14	RX Filter Shifting	178
7.15	Select RX Filter presets	178
7.16	ZOOM-In/Out the panorama	179
7.17	Squelch level adjusting	180
7.18	DSP Functions	180
7.19	IQ files recording	181
7.20	Frequency Tuning STEP Changing	182
7.21	Antenna switch	182
7.22	Functional buttons using	183
7.23	DRIVE level adjusting	185
7.24	Microphone gain control	186
7.25	TX Monitoring Gain	186
7.26	Voice Recorder Operation	187
7.27	Transverter mode operation	188
7.28	Transmitting in CW mode	188
7.29	Transmitting in Voice mode	189
7.30	DAC OUT operation	189
7.31	CTCSS Tones using	190
7.32	Burst Tone using	190
7.33	Bandscope operation	191
8.	SPLIT OPERATION	191
8.1	SPLIT + Sub RX Operation	192
9.	SUB RECEIVER USING	193
10.	RIT/XIT OPERATIONS	193
10.1	RIT	193
10.2	XIT	195
11.	SHIFT BUTTONS OPERATION	195
12.	DIGITAL MODES OPERATION	196

13. RX2 OPERATION

196

1 READ IT FIRST

1.1 Congratulations

On behalf of the whole Expert Electronics company, we'd like to thank you for purchasing one of the best modern SDR transceivers!

The MB1 transceiver consists of an SDR transceiver and a fully functional PC in a single case, thus providing limitless opportunities and flexibility for numerous applications!

1.2 Features

Check out this section before you start operating on the air.

Here you will learn about transceiver's features, supplied accessories, precautions and the license agreement.

The MB1 transceiver is a game changer, it's a transceiver and a PC in a single package. It has a classic design, developed over several decades, with the most advanced DUC/DDC SDR-technologies - Direct Down Conversion (DDC) and Direct Up Conversion (DUC) and a fully-featured high-end personal computer with an Intel Core i5 processor on board.

Features of the transceiver

- Independent RX path based on **DDC** (Direct Down-Conversion) architecture
- Independent TX path based on **DUC** (Direct Up-Conversion) architecture
- **2** software RXs + SubRX for each of them (**4 slices total**) + independent wideband **Bandscope up to 80 MHz**
- ExpertSDR2 software in two styles: Desktop style and MB1 display (for integrated GUI)
- **Remote control** operation, using it, you connect PTT and CW-key to the E-Coder panel. Microphone and E-Coder are connected to the remotely set up PC
- **TCI interface** for seamless connection with third-party software like **SDC** (with its own Skimmer), **LogHX**, **SWISSLOG** and **RUMlog**, more are coming
- **Professional TX processing module** provides the most advanced tuning capability for voice operation
- High-quality **IPS 7" touchscreen** display with a **1280x800** resolution
- Supports any software applicable for Windows 10 OS
- **ExtCtrl** connector to control external devices with 8 powerful keys with open collector
- **COM-port** for connection of external devices, like PA, antenna switches etc.
- **ALC** connector for external power amplifiers*
- Has a special **XVTR** connector for **VHF transverters****

- **4** separate programmable **PTT outputs** for external power amplifiers
- An opportunity to use the transceiver as a signal generator via **DAC OUT** connector
- An opportunity to use external filters in the middle of the RF path, using **RX IN** and **RX OUT**
- Small **delay** in **CW** mode (about **10 ms**)
- Input for external 10 MHz reference oscillator
- An opportunity to use the transceiver in **SO2V** mode
- **Full duplex** or half duplex modes^{***}
- **4 HF** and **2 VHF** antenna connectors
- Internal power-meter for HF and VHF bands and SWR-meter for HF band
- Record and play on air fragments (**IQ files**) with a bandwidth of up to **312 kHz**
- **Internal ATU** (Automatic Tuner Unit)
- The embedded power supply unit

* ** *** These functions are supported by the transceiver's hardware, but is not implemented in the ExpertSDR2 software. They will be supported in the future ExpertSDR2 software releases.

PC capabilities of your transceiver

- Installation of digital modes software
- Installation of HAM and Contest logs
- Two CW Skimmers may be used on different bands
- The transceiver can connect to the LAN and the Internet
- Use of Internet applications (e.g. e-mail, Skype, ICQ, TV, etc.)
- Play video and audio files
- Watch TV via USB-receivers
- An opportunity to connect two external displays, keyboard, mouse
- An opportunity to connect external speakers into the PHONES jack on the front panel

1.3 Supplied accessories

The transceiver may be supplied with the additional option - Automatic Tuner Unit (ATU) for matching impedance of antennas and 50 ohm output path of the transceiver.

Basic configuration:

- MB1 transceiver
-

Note:

• *ATU is **not** installed in the transceiver in the Basic configuration*

- PTT-microphone MD15
- Power Supply Cable to connect the transceiver to AC mains network
- Backup fuse 5A

Standard configuration:

- MB1 transceiver + ATU
-

Note:

• *ATU is installed in the transceiver in the Standard configuration*

- PTT-microphone MD15
- Power Supply Cable to connect the transceiver to AC mains network
- Backup fuse 5A

Additional equipment:

Additionally you can purchase the following devices:

- [E-Coder panel](#), [E-Coder Plus panel](#) or [E-Coder mini kit](#) for convenient remote operation
- [PTT footswitch](#)
- [HPF for VHF](#)

1.4 Precautions

To prevent any damage to the transceiver, please read these operating rules carefully before attempting to operate on the air.

- Carefully read this manual first, otherwise connecting and operating the MB1 could lead to the fatal errors
- Before connecting the device to AC network 110-220 V 50-60 Hz, visually inspect the MB1 for the absence of mechanic damage
- **DO NOT** use the MB1 in temperatures lower than 0°C (32°F) and higher than +60°C (140°F)
- If the MB1 was stored in abnormal climatic conditions, it is recommended to keep it in normal operating temperature for at least 2 hours before switching on
- Before connecting the MB1 to AC network, ensure it is grounded. **Never** use the MB1 transceiver without grounding!
- Before connecting external devices read the **Connections** section
Note, the MB1 output switches are limited to the values of the supply voltage and the current passing through them, **do not** allow polarity reversal
- Connect external devices to the MB1 **only** according to wiring diagrams shown in this manual
- **Never** connect external devices, which are live or in a switched-on condition, to the MB1
- Use **only** AC networks in the range of 110-220V. Remember - the device supplied with AC voltage with a frequency of 50-60 Hz
- **Never** use or store the MB1 in dusty rooms, nor allow prolonged exposure to direct sunlight
- Avoid the exposure of atmospheric downfalls on the MB1 and never spill any liquids (especially aggressive) on it
- **Do not** emit HF/VHF signal with power more than 1W in the same room or near the MB1 transceiver
- **Do not** open the MB1. It contains radio components, which are highly sensitive to static electricity. For any repairs of the device please contact us
- **Do not** transmit without a load (dummy load/matched antenna) - this will lead to overheating of the active output components, and may cause their thermal breakdown. The same applies to an unmatched load
- If the transceiver emits an abnormal odor, or smoke, **immediately** turn it's power OFF and remove the power cable. Contact the nearest Expert Electronics dealer for advice
- **Never** stand the transceiver on the front or rear panel - this may damage controls and/or the display
- **Always** take great care when moving or transporting the transceiver

- Maintain a minimum distance of 10cm between the cooling vents of the transceiver and another object
Never cover the cooling vents which must always be open to allow sufficient ventilation. Failure to do so may cause malfunctions
- Be careful to avoid dropping metal objects (screws, clips, metal filings, etc.) through the vents, which may cause damage to the transceiver
- **Always** disconnect the antenna from the MB1 when not in use or if there is a danger of atmospheric electricity
- Ground the antenna-mast and antenna-feeders to avoid accumulation of atmospheric static electricity on them
- **Always** use ferrite beads on antenna and other cables, connected to the transceiver
- Ensure the MB1 and any connecting cables are free from effects of electromagnetic interference and uncontrolled currents and voltages
- To avoid damage to the MB1 or causing harmful interference on air, it should be operated **only** by competent HAM amateurs
- Keep the MB1 out of reach of children

1.5 Software license agreement

1.5.1 ExpertSDR2 Software License Agreement

The MB1 transceiver runs under the ExpertSDR2 software.

ExpertSDR2 software is the proprietary product and intellectual property of the Expert Electronics. It is forbidden to modify, copy or disclose to third parties ExpertSDR2 software distribution.

When shipped the MB1 transceiver supplied with the latest official ExpertSDR2 software. Official versions of the software are published on the manufacturers website in the "MB1 Transceiver/Downloads" section.

New versions of the MB1 transceiver software may have different titles from time to time. This license agreement applies to all new versions of the software and may be supplemented and / or amended unilaterally by the Expert Electronics.

The manufacturer reserves the right to alter and / or improve the MB1 transceiver software, adding new features and bug fixes. In this regard, the software may be different from the description herein. Ask your closest dealer on the availability of new, more complete version of the User Manual, or look for them on the official website of the manufacturer in the "MB1 Transceiver / Documentation" section.

Users of the MB1 transceiver can update the software by themselves, by downloading it from the official Expert Electronics website.

The manufacturer is not responsible for consequences of the user utilizing an unofficial or modified version of the ExpertSDR2 software on the MB1 transceiver and/or changes the settings or other files which are related to the ExpertSDR2 functionality.

1.5.2 Windows 10 Software License Agreement

The built-in PC of the MB1 transceiver, runs under the licensed Microsoft Windows 10 OS.

Use the Windows 10 OS according to the Microsoft license agreement.

You can read the Microsoft License Agreement in Windows settings: START--SETTINGS--System--About--Read the Microsoft Software License Terms.

MB1 User is responsible for compliance with the Microsoft License Agreement. The manufacturer assumes no responsibility for compliance with the Microsoft License Agreement.

1.5.3 Other Software License Agreement

The user can install any third-party software on the MB1 transceiver, supported by Windows 10 Home OS, 64 bit.

If you install third-party software you must follow:

- The license agreement of the ExpertSDR2 software
- The Microsoft Windows 10 license agreement
- A third party software license agreement, which you are going to install or is already installed

The manufacturer assumes no responsibility for the material, moral or any other kind of damage, whether expressed or implied, caused by using of a third-party software.

The manufacturer assumes no responsibility for the material, moral or any other kind of damage, whether expressed or implied, caused by the virus-software, which may appear while using the MB1 transceiver.

The manufacturer assumes no responsibility for the material, moral or any other kind of damage, whether expressed or implied, caused by using of external devices along with the MB1 transceiver.

1.6 Copyrights

Expert Electronics company holds copyrights for the MB1 transceiver, intellectual property: ExpertSDR2 software, MB1 Utility and all User Manuals and Instructions for the device and software.

Before you are going to share this document in the Internet or via email, get written (or via email) permission to do that.

It is forbidden to present this document as your own, sell it or use it in any other commercial activity.

Expert Electronics company does not guarantee, that the functions and their qualities described in this manual, and also combinations which were not described in the manual, comply with the User purposes, if it is not mentioned in the Manual. Expert Electronics company does bear any responsibility for material, moral and other kinds of damage to the expressed or implied for such actions.

1.7 Contacts

MANUFACTURER

Expert Electronics LLC

Web-site: www.eesdr.com

E-mail: info@sunsdr.com

You can contact us via mentioned above mail address: your orders, inquiries, technical support, software support.

2 CONNECTIONS

2.1 Antenna

Before connecting the antenna, check the integrity of the antenna-feeder path.

For best results, the antenna should have an impedance of 50 Ohm to match the 50 Ohm impedance of the HF nodes of the transceiver.

The antenna should have SWR level not worse than 1.5:1. If the SWR is worse than 1.5:1, match the cable and the antenna to the desired level and/or use an ATU.

Note:

• *Using a mismatched antenna-feeder path might cause non-linear distortion of the transmitted signal, HF interference on the transceiver's cables and/or interference of TV's or other devices.*

• *Transmitting with a receiving antenna may damage it.*

Warning!

① **Always use E-type ferrite beads on antenna and other cables, connected to the transceiver!**

2.2 Grounding

To eliminate the risk of electric shock it is essential to use a reliable grounding connection for the transceiver.

Warning!

① **Never use water or gas pipes for grounding!**

① **Never use the MB1 transceiver without a reliable grounding!**

2.3 AC power

Connect the transceiver to the AC mains network with the power cable supplied with the transceiver. Make sure, that the power outlet has the grounding/earth terminal and that it matches the type of the power cable in use.

Warning!

① **It is recommended to set the E-type Line Filter on the Power Supply cable near the rear panel of the transceiver.**

2.4 Front Panel accessories

You can connect different accessories to the front panel of the MB1.

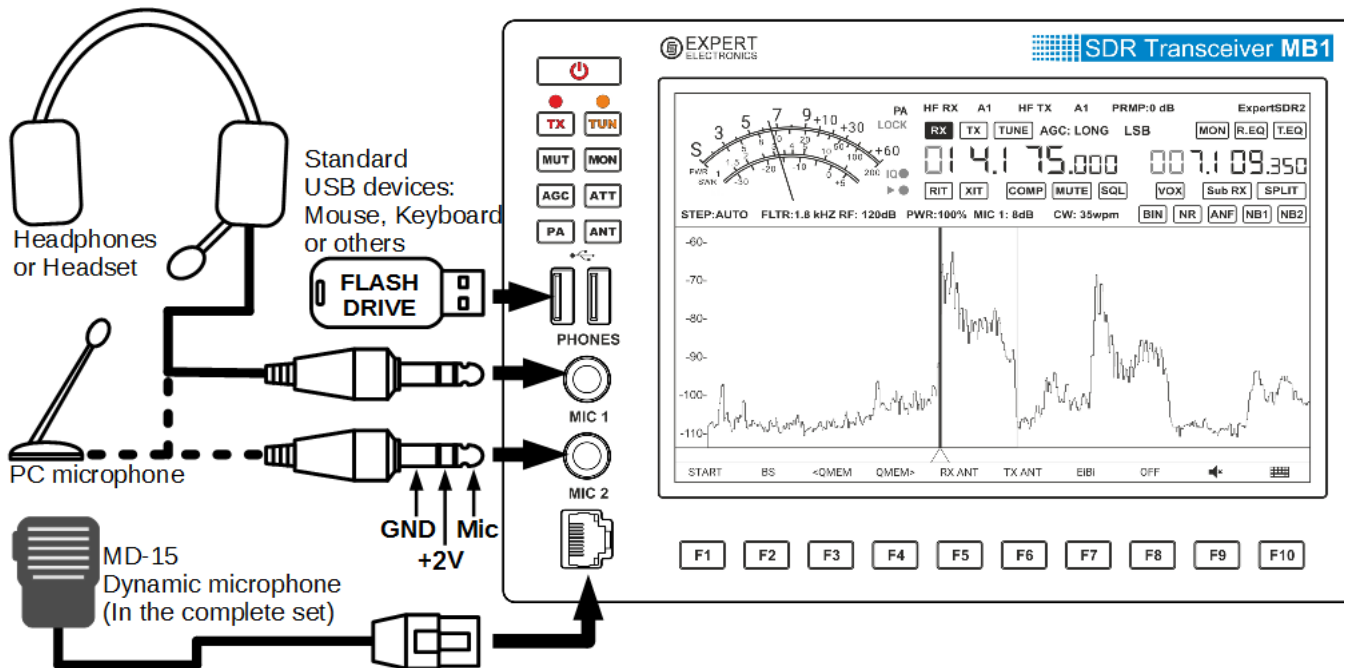

2.4.1 Microphone(Dynamic/Electret)

Dynamic microphone. The transceiver's kit includes a standard dynamic MD-15 microphone with a PTT button - to activate transmission.

MD-15 microphone connects to the **MIC2** connector on the front panel of the transceiver.

MIC 2 microphone input is designed to connect dynamic microphones with an output impedance of 500-600 Ohm. You can find **MIC 2** connector pin-out in the [MIC 2](#)¹²⁶ section.

Note:

By repeated short presses of the **MIC** button, you can select the **MIC 2** input in the software, to work with a dynamic microphone.

Electret microphone is not supplied with the transceiver.

MIC 1 microphone input on the front panel of the transceiver is designed to connect electret microphones.

You can connect any computer or other electret microphones via the Jack adapter 6.3mm - 3.5mm.

Note:

By repeated short presses of the **MIC** button, you can select the **MIC 1** input in the software, to work with an electret microphone.

Line-In input.

MIC 1 input on the front panel of the transceiver can be used as a line-in input.

Use the **monophonic** 6.3 mm Jack Plug for connection.

2.4.2 Headphones

Connect headphones to the **PHONES** jack. It's allowed to use headphones with a 8-64 Ohm impedance or active speakers.

To connect headphones use the **stereo** 6.3 mm Jack Plug.

Warning!

① **Never use headphones with a mono connector! If you have a monophonic headphones, use the stereo 6.3 mm Jack and connect them to one of the channels.**

① **Never connect two stereo channels with each other!**

Note:

• *When you connect headphones to the transceiver, the internal speaker will continue to operate. To disable it, open the MIXER local panel and turn off the speaker with the SPEAKER button (more details in [Local panels](#) ).*

• *Headphones with high impedance may sound quieter.*

2.4.3 USB devices

You can connect any standard USB device with a current consumption of up to 500 mA to **USB** connectors e.g. flashcards, mouse and keyboard, wireless mouse and / or keyboard, WLAN adapters etc.

Note:

• *After connection of the USB device, it may take some time to automatically search and install drivers for it. After installation, the OS will begin to work with the USB device in regular mode.*

• *In some cases, it may be required, to search for drivers over the Internet and / or use manual installation.*

• *Older USB devices may not be supported by the Windows 10 Home x64. Read the Instructions for your USB device to make sure that it is supported by the Windows 10 Home x64 OS.*

2.5 Rear Panel

2.5.1 Accessories

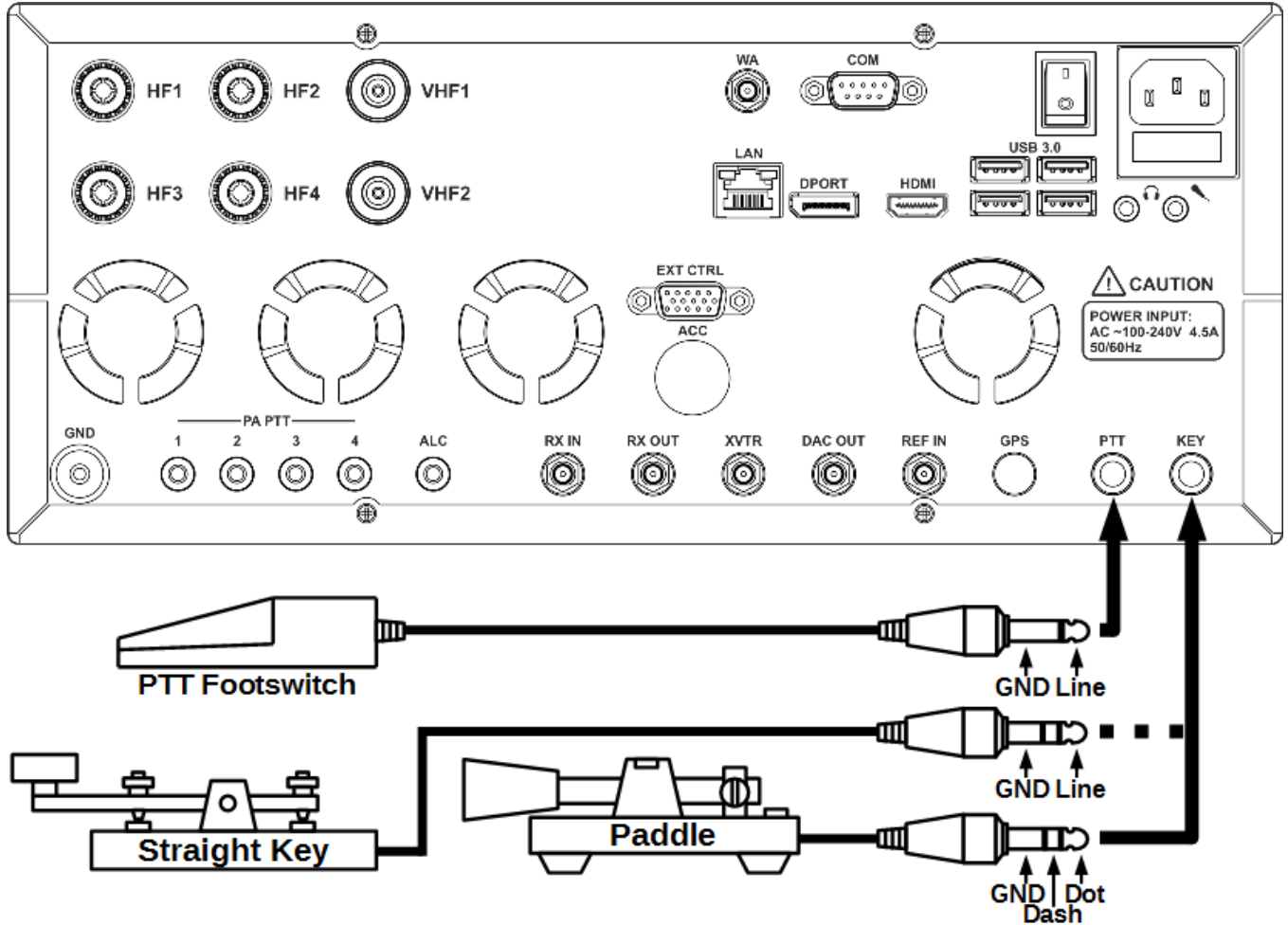

You can connect several accessories to the transceiver's rear panel, as shown on the picture above.

PTT Footswitch should be connected to the **PTT** socket, it controls the transceiver's TX mode. Connector type - 6.3 mm Jack.

When you press the footswitch, **PTT** Line connects to the Ground (Case), it causes the transceiver to turn to TX. A red LED TX indicator on the front panel and in the software window, indicates that the TX mode is on.

Releasing the footswitch returns the transceiver to the RX mode.

Straight Key should be connected to the **KEY** socket using the stereo 6.3 mm Jack, with disconnected ring contact. Pressing the key turns the transceiver to the TX mode and it generates a continuous CW signal (manual mode). Manipulate the key according to the message you want to send.

Releasing the straight key returns the transceiver to the RX mode.

Twin-paddle key (single-paddle) should be connected to the **KEY** socket using the mono 6.3 mm Jack. Pressing one of the key's paddles (or one side - for single-paddle) will turn the transceiver to the TX mode and begin automatic generation of dots and dashes. Releasing the paddle returns the transceiver to the RX mode.

Note:

• *Adjusting and switching of manipulation modes, speed and other parameters of the CW signal, can be done in the local panel on the transceivers display (more details in [Transmitting in CW mode](#) ⁸⁸).*

COM-port for connection of a CW key.

CW paddle can also be connected to the **COM**-port according to the picture below.

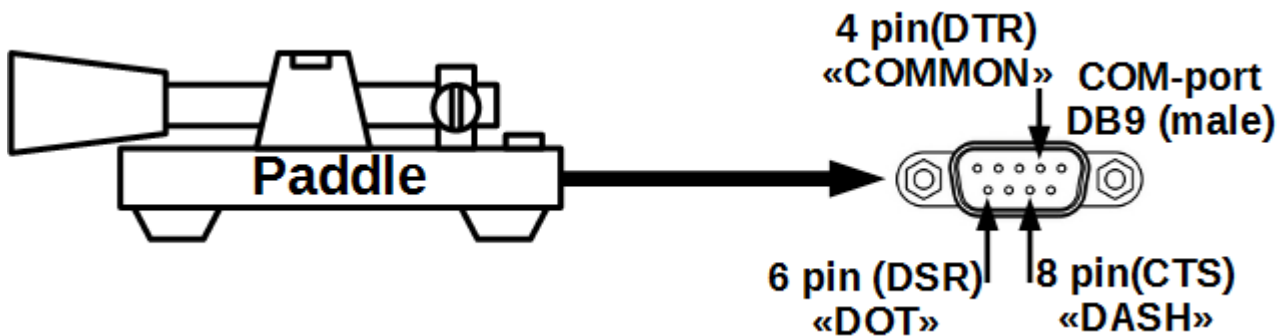

In the ExpertSDR2 DOT/RTS = DOT/CTS and DASH/DTR = DASH/DSR.

In the ExpertSDR2 you set COM-port pins of an external PC, which uses DTR and RTS for keying. DTR and RTS from an external PC should be connected to local DCR and CTS pins, which are showed on the picture with the paddle. DCR and CTS are RX lines (inputs) that is why they used like this.

Warning!

① **While connecting a CW key to the COM-port, avoid any contact of the key with the transceivers's case, other devices' chassis and/or any other earth point!**

2.5.2 External PC

The transceiver can be connected to another PC with a **COM**-port cable. Using a **COM**-port cable and the CAT-system, you can adjust the transceiver's frequency and other parameters.

Note:

- *The cable type should be Null modem / crossing.*
- *While connecting the cables, the transceiver and a PC should be switched off.*

The transceiver may be connected to the other PC via Ethernet cable. This connection creates a local network between a PC and the transceiver. There are may be more PCs if you connect them via commutator or router.

The transceiver may be connected to another PC via a WLAN connection. To do that, connect a WLAN adapter to a **USB**-port.

Also you may want to send audio signals to the transceiver and/or receive them from the transceiver.

To do that you may use MB1's audio card (on the rear panel) or the audio card of the other PC.

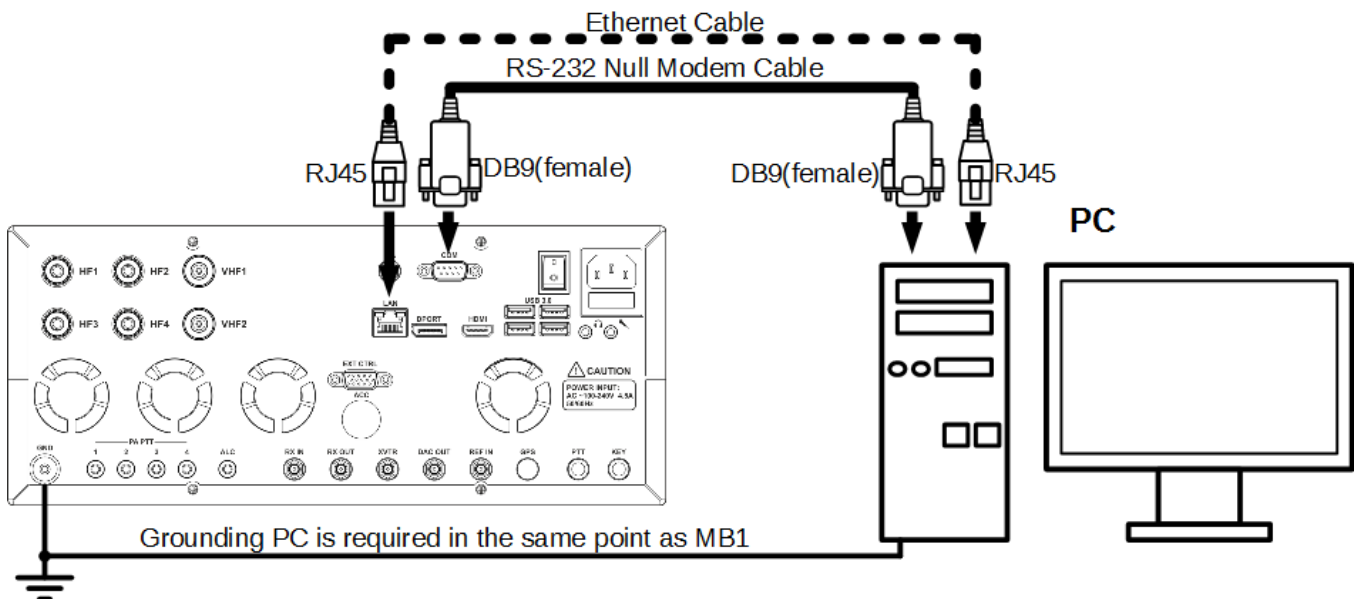

2.5.3 External Linear Amplifier

You can connect external Power Amplifiers (PAs) to the transceiver.

It may be required to make several connections depending on the required external PA type.

Connect a 50 Ohm HF cable to one of the transceiver's antenna connectors HF1 ... HF4 (SO 239) or VHF1 ... VHF2 (N-type) if it's a VHF PA, connect the other end of the cable to the input of the PA.

If the PA supports the **control via the CAT system** for switching bands and / or tuning of the HF circuits, you can use the "null modem" **COM**-port cable to control it.

To switch the PA to the TX mode, normally used a connection of the PA's control line and the PA's case. The MB1 transceiver has four separate **PA PTT keys** for connecting control lines and the case, for four external PA's. Use one of the lines to control a PA's transmission mode with RCA-type phono plugs. If required you can set the switching delay of an external PA from RX to TX and back from TX to RX, in the transceiver's settings (more details in [Local panels](#)⁵⁴).

If an external PA supports operation with the transceiver's **ALC** system, you can connect it via cable with RCA-type phono plugs. The ALC voltage range -3...0 V (see the **warning** below).

To control the TX mode of the external PA you can also use the X8 pin terminal of the **EXT CTRL** connector (more details in [EXT CTRL devices](#)²²).

Note:

- While connecting the cables, transceiver and PA should be switched off.
- If the **COM**-port of the transceiver is not available for some reason, then instead of the **COM**-port cable you could use the cable with a **USB-COM** adapter and one of the transceiver's **USB**-ports. In this case, the virtual **COM**-port of the adapter should be set up in the **MB1 OS**.

Warning!

- ① There is a small delay in the **ALC**-system functionality, which may lead to a short-term overload of the external **PA**. This phenomenon could cause off-frequency emissions or failure of your **PA**! The User of the **MB1** transceiver should understand and accept the above, taking responsibility for the potential consequences of the use of the **ALC**-system. The manufacturer is not responsible for direct or indirect damages of any kind from using the **ALC**-system.

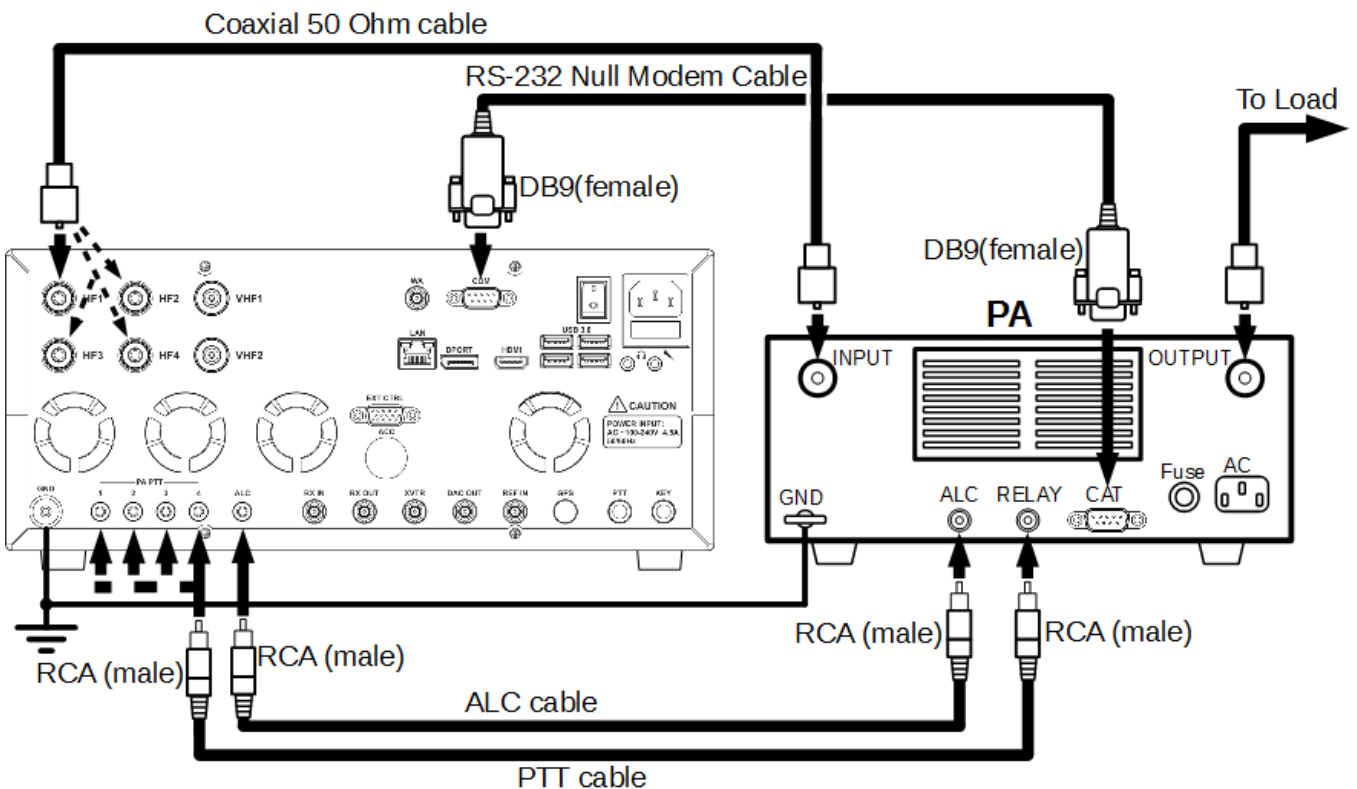

2.5.4 External Control devices

The **MB1** transceiver allows you to control external devices via seven electronic keys in the **EXT CTRL** connector.

The picture below shows the connection schematics between the relay and the pins of the **EXT CTRL** connector. With the keys you can have direct control of antennas, external band pass filters, external PA's bands, HF preamplifiers, external transverter PTT etc.

Commutation depends on the band and **RX/TX** mode.

You can adjust keys' triggers in the software Settings (more details in [EXT CTRL](#)¹⁰²).

Note:

- The Electronic keys have a built-in protection diodes for inductive loads (relays, fans, solenoids, etc.) with a maximum reverse voltage of 75 V and current up to 200 mA (1N4148 diodes). If your inductive load gives a higher reverse current, it is necessary to use an external diode in parallel to the connected load. See the diagram below.
- The X8 key is designed for control of the external PA.
- The total load on the power output + 12V (Conn. 14) of the **EXT CTRL** connector must be less than 1 A.
- There is a protective fuse for a current of 1 A installed on the SDR board.
- There is a diode connected with the power output + 12 V (Conn. 14) in a chain, to avoid an outside voltage supply reaching inside the transceiver.

Warning!

- ① Never use a VGA cable from your monitor, to connect external devices
- ① Never connect monitors with the VGA interface to the ExtCTRL connector
- ① Incorrect connection of external devices and / or uncontrolled galvanic connections could lead to the malfunctions of the MB1 transceiver or its failure!

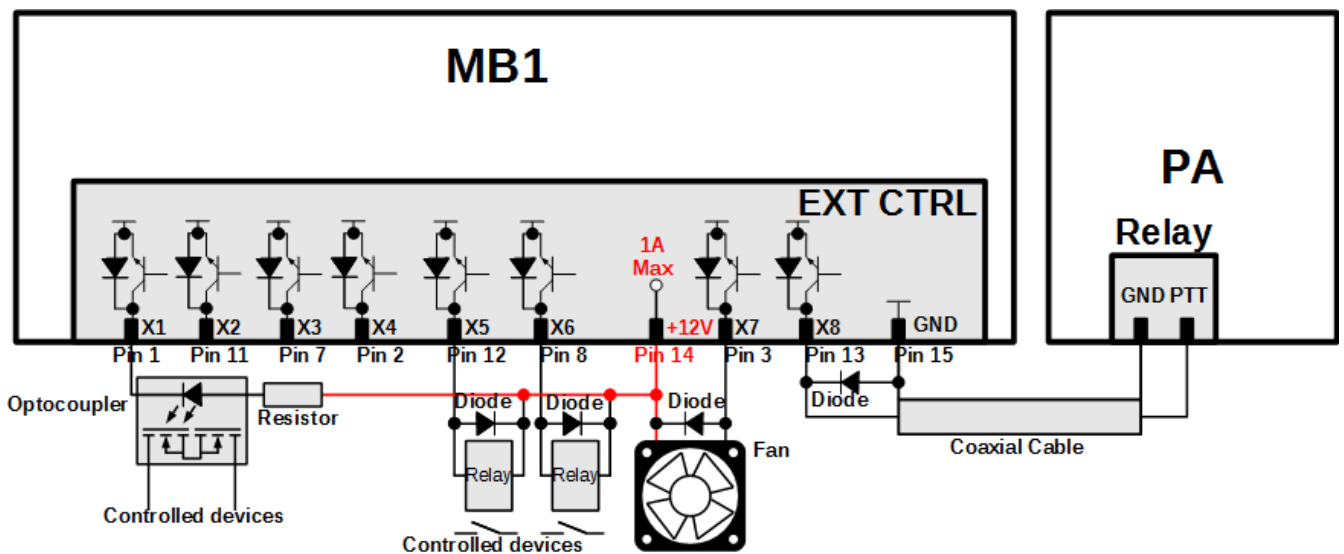

2.5.5 Reference input

A 10 MHz external reference oscillator can be connected to the **REF IN** connector with a coaxial cable.

Set the **Use External Reference Input** checkbox in the ExpertSDR2 menu to use an external reference oscillator (more details in [Options](#)⁹³).

Signal parameters of the Reference Frequency:

- Reference signal frequency of 10 MHz
 - Reference signal voltage: min. 2.5 V (peak-to-peak) max. 3.3 V (peak-to-peak)
 - Input impedance of 500 Ohm
 - SMA type connector (female)
-

Note:

- *Use an external reference oscillator via **REF IN** connector to increase the stability of the transceiver's tuning frequency, if the MB1's +/- 0.5 ppm stability is not enough. Also transceiver's frequency synchronization with an external reference oscillator is used when you want to sync several devices with each other, from one reference oscillator.*
 - *The Phase frequency of the transmitted and received signals depends on the phase frequency of the external reference oscillator.*
-

2.5.6 XVTR

Connect VHF, SHF transverters to the **XVTR** connector of the transceiver.

In the RX mode, the XVTR functions as an input, in the TX mode the XVTR functions as an output.

In the TX mode, there is a constant + 5V on the signal line with the HF signal. This constant voltage may be used for automatic control of the transverter in the TX mode.

VHF, SHF transverter may also be connected to the transceiver via the **RX IN** and **DAC OUT** connectors.

RX IN used as the input in the RX mode. **DAC OUT** used as the output in the TX mode.

The **DAC OUT** does not have a constant voltage to control the TX mode, so it is necessary to use an additional control line while you use the **DAC OUT** in the TX mode. For this you may use any **EXT CTRL** key connector or **PA PTT** line (more details in [EXT CTRL devices](#)^[22]).

XVTR input/output parameters:

Intermediate Frequency: 1...70 MHz, 90...150 MHz

IF band: up to 80 MHz

Impedance: 50 Ohm

XVTR input sensitivity: -115 dBm

Signal level in TX mode: +10 dBm (max)

DC level: +5 V (in TX mode)

2.5.7 DAC OUT low power output

The **DAC OUT** is the transceiver's low-power output, which functions in the wide frequency band. It could be used for connection of external power amplifiers, transverters and as a source of measuring signal.

To use the **DAC OUT** enable it in the [FRONT END SETTINGS](#)^{D57} panel.

DAC OUT output parameters:

Max output power: 10 mW

Frequency band: 0.1...150 MHz

Transmitted signal band: 20 kHz

Impedance: 50 Ohm

Signal level: +10 dBm (max)

2.5.8 RX IN and RX OUT

The **RX IN** connector is the direct receiver input, bypassing Band Pass Filters (BPFs). Use the **RX IN** for connection of RX antennas, transverters, additional BPFs, preamplifiers, attenuators etc.

Note:

- The signal from **RX IN** connector goes to the ADC input and may be amplified by the +10dB preamplifier, if you set it in the software.
- ATT is disabled when you use **RX IN** alone, without **RX OUT**.

Warning!

- ① **Maximum allowed signal level on the RX IN connector is 0.3V of the active voltage (RMS). Do not exceed this level, it may result in the transceivers overload and ADC fatal damage.**

The **RX OUT** connector is the output of the transceivers receive path. When the **RX IN** is enabled, the signal received on the HF path from the active antenna input, goes to the RX OUT. Between the **RX OUT** and **RX IN** connectors may be added an additional filter or box of switched filters, preamplifier, attenuator, signal divider etc.

Note:

- The signal passing through the HF path, with output via **RX OUT**, may be attenuated by the -20dB attenuator, if you set it in the software.
-

2.6 Connectors pin-out

2.6.1 MIC1

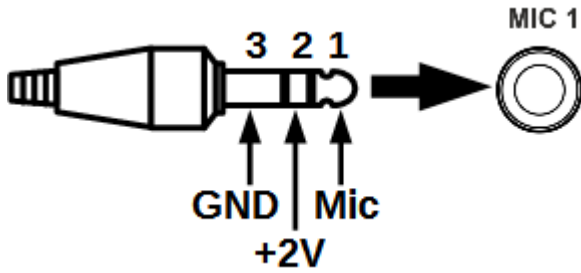

Out #	Output name	Description	Note
1	MIC	Mic signal input	Input
2	+2V	DC 2V supply into the MIC	Output
3	GND	Ground	--

2.6.2 MIC2

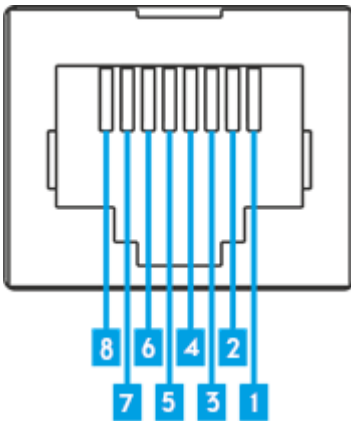

Out #	Output name	Description	Note
1	FST TNG	Not implemented in the software	--
2	GND	Ground	--
3	PTT TNG	PTT signal input Connection of the PTT to the GND will turn the transceiver to the TX mode	Input
4	MIC	Mic signal input	Input
5	MIC_GND	MIC case	--
6	+5V	DC 5V output with maximum current up to 20 mA	Output
7	UP TNG	Not implemented in the software	--
8	DWN TNG	Not implemented in the software	--

2.6.3 COM

COM (Male)

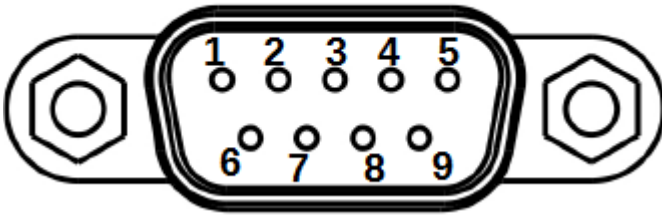

Out #	Output name	Description	Note
1	DCD	Data Carrier Detect - DCE is receiving a carrier from a remote DCE	Input
2	RxD	Received Data - Carries data from DCE to DTE	Input
3	TxD	Transmitted Data - Carries data from DTE to DCE	Output
4	DTR	Data Terminal Ready - DTE is ready to receive, initiate, or continue a call	Output
5	GND	Ground	--
6	DSR	Data Set Ready - DCE is ready to receive commands or data	Input
7	RTS	Request To Send - DTE requests the DCE prepare to transmit data	Output
8	CTS	Clear To Send - DCE is ready to accept data from the DTE	Input
9	RI	Ring Indicator - DCE has detected an incoming ring signal on the telephone line	Input

2.6.4 EXT CTRL

EXT CTRL

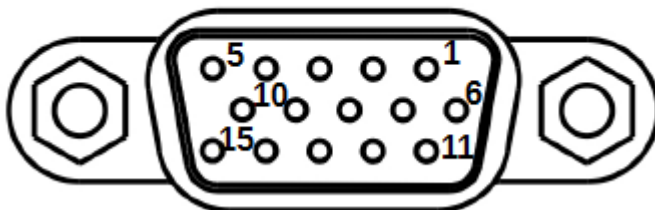

Out #	Output name	Description	Note
1	X1	Programmable key with open collector	Output

2	X4	Programmable key with open collector	Output
3	X7	Programmable key with open collector	Output
4	RB	RS-485 (-) Line	Input/Output
5	I2	Connection of buttoned detector. Connect to ground. In reserve.	Input
6	CP	Contact of protected diode	--
7	X3	Programmable key with open collector	Output
8	X6	Programmable key with open collector	Output
9	RA	RS-485 (+) Line	Input/Output
10	I1	Connection of buttoned detector. Connect to ground. In reserve.	Input
11	X2	Programmable key with open collector	Output
12	X5	Programmable key with open collector	Output
13	X8(PTT)	Programmable key with open collector for control of external PAs PTT	Output
14	+12V	DC 12V supply, current up to 500 mA There is a 1A fuse integrated in the line	Output
15	GND	Ground	--

Note:

- When an electronic key with open collector triggers, it leads to key's ground connection. Voltage drop equals 0.7V.
- RS-485 interface is reserved.
- Logic inputs of the buttoned detectors are reserved.

Warning!

- ① **Maximum allowed current via electronic keys is 450 mA!**
- ① **While connecting an inductive load (relay, solenoids, fans etc.) to the X1-X8 keys, it's important to connect the protective diode in parallel to the load!**

2.6.5 PA PTT Outputs

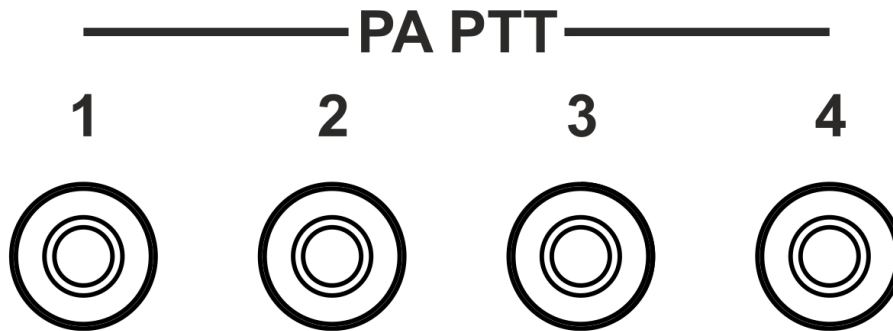

Central contact of the RCA connector connects to the electronic key with open collector. Cases of the connectors are connected to the transceivers case.

Note:

•Trigger of the electronic key with open collector, leads to key's ground connection. Voltage drop equals 0.7 V.

Warning!

- ① Maximum current allowed via electronic keys is 150 mA!
- ① While connecting 1-4 inductive loads (relay, solenoids, fans etc.) to the electronic keys, it's important to connect the protective diode in parallel to the load!
- ① In MB1 transceivers released after 15.05.2016 installed relays instead of electronic keys.
Relays contacts are opened.
Maximum current allowed via relay 2A.

3 FRONT PANEL DESCRIPTION

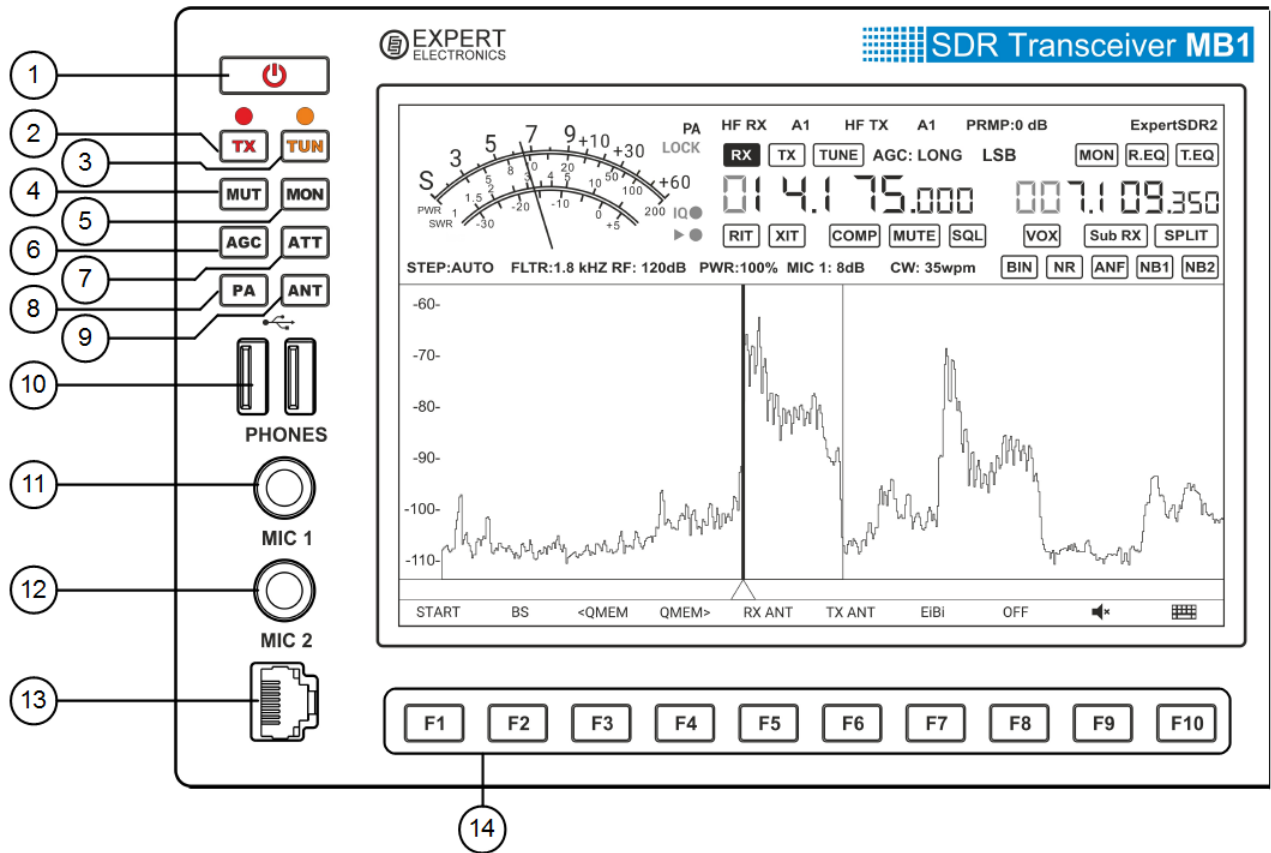

- 1)  **Power button.**
Press the power button to turn **on/off** the transceiver (more details in [Turning ON/OFF the transceiver](#)¹⁶⁷).
- 2) **TX** - The TX mode button.
Press the button to turn the transceiver to the TX mode.
A red LED indicates that the TX mode is on. Press the **TX** button again to return to the RX mode.
- 3) **TUN** - Automatic Tuner Unit button.
Short press the button to start the matching process (more details in [ATU](#)⁵⁴).
An orange LED indicates that the matching mode is switched on.
Press and hold the button to open the **ATU** local panel (more details in [ATU](#)⁵⁴).

Note:

•In devices without ATU, if you press the TUN button the transceiver will go to the TX mode and will transmit the center frequency.

- 4) **MUT** - Mute button.
Short press the button to turn off the volume, press it again to restore the volume.
Press and hold the button to open the **MIXER** local panel (more details in [MIXER](#)^{□62}).
- 5) **MON** - TX monitoring button.
Press the button to monitor the transmission, press it again to turn off the monitoring.
- 6) **AGC** - AGC modes button.
Press the button to select the required AGC mode.
Long press the button to switch off the AGC.
Successive presses cycles through the AGC modes. (more details in [AGC presets choosing](#)^{□175}).
- 7) **ATT** - Preamplifier button.
Short press the button to select the required level of the receiver's preamplifier.
Successive presses cycle through the preamplifier levels.
Press and hold the button to open the FRONT-END local panel (more details in [ATT/PREAMP control](#)^{□174}).
- 8) **PA** - Power amplifiers control button.
Short press the button to enable an external PA in the TX mode.
Press and hold the button to open the PA local panel (more details in [PA](#)^{□103}).
- 9) **ANT** - Antenna switch button.
Short press the button for synchronous (for RX and TX) antenna switching.
Successive presses cycle through the antennas.
Press and hold the button to open the FRONT-END local panel (more details in [FRONT END](#)^{□57}).
- 10) **USB** - Connectors for USB devices.
Connect standard USB devices (mouse, keyboard, disk module and others) to these connectors.
The load current should not exceed 500 mA.
- 11) **PHONES** - Headphones jack.
Connect a headphones with an 8 ... 64 Ohm impedance to the PHONES jack.
For example, a standard computer headset with a stereo jack connector.
- 12) **MIC 1** - Electret microphones jack. Line-in.
Connect an electret microphone to the **MIC 1**, for example a standard computer headset microphone.
This jack can also be used as a standard line-in (more details in [Microphone \(Dynamic/Electret\)](#)^{□17}).

13) **MIC 2** - Dynamic microphones jack.

Connect a dynamic microphone to the **MIC 2** (e.g. the MD-15 supplied with the transceiver). This input supports microphones with a 400 ... 600 Ohm impedance.

14) **F1...F10** - Functional buttons.

You can assign different functions on the F1...F10 buttons (more details in [Functional buttons using](#) ¹⁸³).

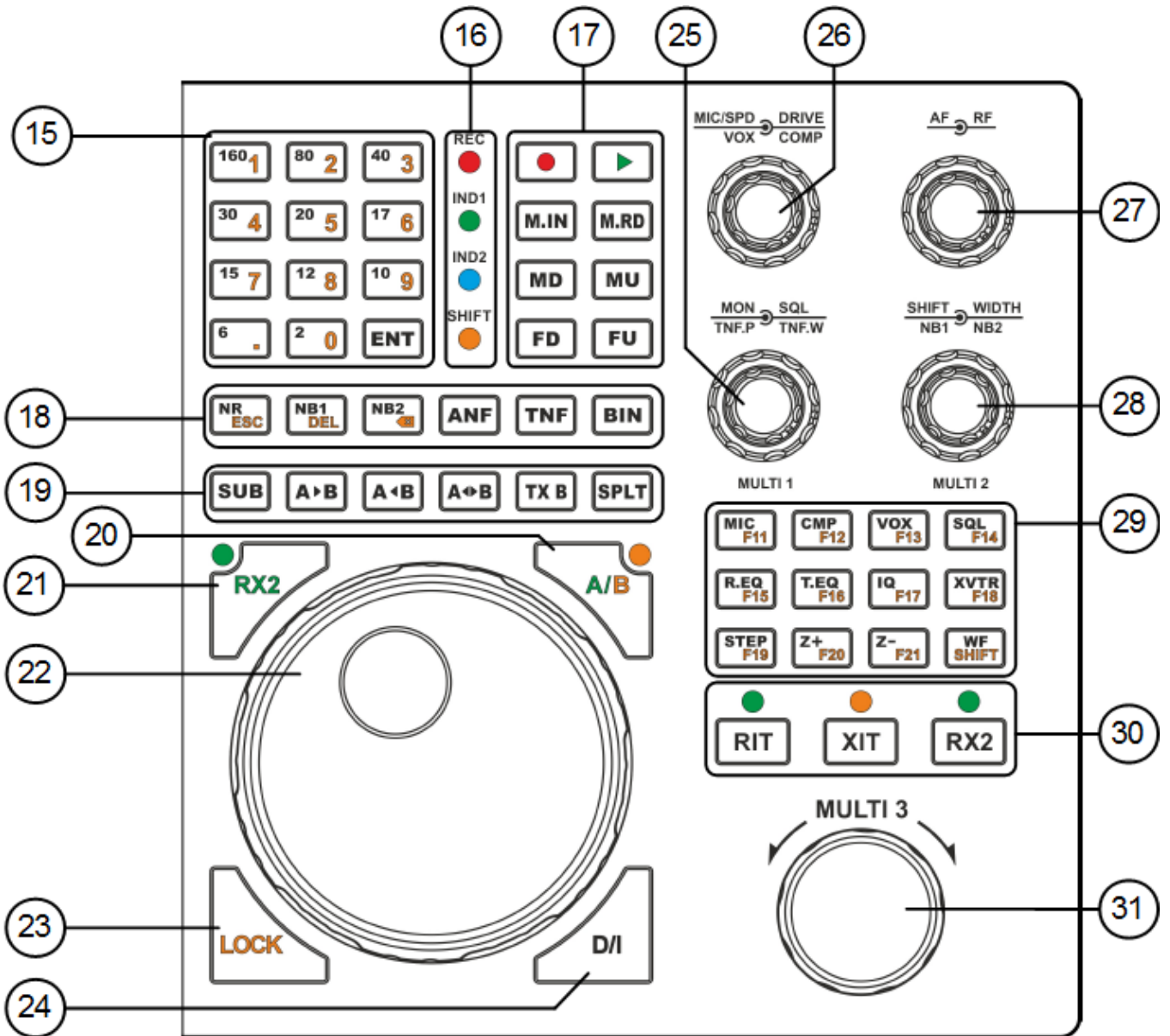

15) **160...2** - Band buttons.

Press the corresponding button to go to the required band.

Each band button has three memory stacks (more details in [Using the band memory](#) ¹⁷¹).

ENT - The button to start and confirm manual frequency input.

Press the button to begin manual frequency input, then press it again to confirm the input.

1...0 - Frequency buttons for manual input.

Press required buttons to input the frequency.

16) **LED Indicators** - Mode indicators.

REC - Record mode indicator.

The **red** LED is active when you record.

IND1 - D/I frequency tuning mode indicator.

The **green** LED is active when the IF frequency tuning mode is enabled (more details in [Frequency Tuning](#)¹⁶⁷).

IND2 - Bandscope indicator.

The **blue** LED is active when the bandscope is enabled (more details in [Bandscope operation](#)¹⁹¹).

SHIFT - Secondary functions indicator.

The **orange** LED is active when you enable buttons' secondary functions (more details in [SHIFT Operation](#)¹⁹⁵).

17)  - Record button.

Press the button to start recording the voice signal, then press it again to stop recording (more details in [Voice Recorder Operation](#)¹⁸⁷).

While recording, the **REC** indicator will be active.

Note:

- You can record either received signals from the air or from your own microphone.
 - Remember, recordings of the air signals should be used only for private purposes. MB1 operator bears full responsibility for using such records.
-



- Play button.

Short press the button for simultaneous play and transmit of the signal on air. After the transmitting is finished, the transceiver will turn to RX mode.

Press and hold the **PLAY** button to play the record without transmitting.

M.IN - Save the current frequency.

Press the button to save the current frequency in the transceiver's long-term memory.

M.RD - Recall the saved frequency.

Press the button to tune on the saved frequency.

MD - Mode type down.

Press the button to cycle backward through the mode types - Down the list.

MU - Mode type up.

Press the button to cycle forward through the mode types - Up the list.

FD - Filter down.

Press the button to cycle the RX filter bandwidth Down the list.

FU - Filter up.

Press the button to cycle the RX filter bandwidth Up the list.

18) **NR** - Noise Reduction button.

Press the button to enable the noise reduction of the receiver (more details in [DSP functions using \$\square^{180}\$](#)).

NB1 - The First Noise Blanker button.

Press the button to enable the first noise blanker for impulse interference.

NB2 - The Second Noise Blanker button.

Press the button to enable the second noise blanker for impulse interference.

Note:

- The **NB1** and **NB2** algorithms are different. Try each of them to reach the best impulse interference reduction.
 - The **NB1** and **NB2** Noise Blankers can be used simultaneously.
-

ANF - Automatic Notch Filter button.

Press the button for automatic reduction of the narrowband interference in the RX filter (interference, carrier signals, CW signals, etc.).

Note:

- If there is no interference, **ANF** could slightly affect the reception quality. Disable the **ANF**, if you don't need it.
-

TNF - Tuning Notch Filter button.

Press the button to enable the manual rejection filter for the narrowband interference

(interference, center frequencies, CW signals, etc.).

Using the **TNF.P** and **TNF.W** knobs you can adjust the TNF filter parameters (more details in [DSP functions using](#)¹⁸⁰).

BIN - Binaural audio mode button.

Press the button to enable the binaural audio mode. The phasing of the audio signal within the RX filter gives a stereo-like effect.

19) **SUB** - Sub-receiver button.

Press the button to enable the sub-receiver, it can be controlled with the MULTI 3 knob (more details in [Sub-receiver using](#)¹⁸³).

Note:

• *Reception will function only if the SubRX is in the panorama's bandwidth.*

A>B - Assign VFO A frequency to VFO B.

Press the button to assign the VFO A frequency to the VFO B (more details in [VFO A and VFO B control](#)¹⁷⁶).

A<B - Assign VFO B frequency to VFO A.

Press the button to assign the VFO B frequency to the VFO A (more details in [VFO A and VFO B control](#)¹⁷⁶).

A<>B - Swap VFO A and VFO B frequencies.

Press the button to swap the VFO A and VFO B frequencies (more details in [VFO A and VFO B control](#)¹⁷⁶).

TX B - Start transmission from Sub-receiver.

Press the button to start transmission from a Sub-receiver.

Press the button again to return the transmission to the VFO A.

SPLIT - SPLIT button.

Press the button to receive on the VFO A frequency and transmit on the VFO B frequency (more details in [SPLIT Operation](#)¹⁹¹).

20) **A/B** - Switch control over the Main knob between VFO A and VFO B.

Press the button to control the VFO B frequency from the Main knob.

Button's LED indicates whether the mode active or not.

Note:

• *While the A/B mode is active, the Multi 3 knob controls the VFO A frequency.*

- 21) **RX2** - Switch control over the Main knob from RX1 to RX2.
Press the button to control the RX2 frequency from the Main knob.
The LED in the corner of this button indicates whether the mode is active.
-

Note:

•The button will work only if the RX2 receiver is switched on. See the 30th paragraph of this chapter, how to enable the RX2 receiver.

- 22) **MAIN KNOB** - Main tuning knob.
Rotate the Main knob to tune the RX1 frequency, by default.
But also you can control the VFO A and VFO B frequencies of the first and second receiver (more details in [Frequency tuning](#)¹⁶⁷).
- 23) **LOCK** - Lock the tuning.
Press the button to lock the frequency tuning. This also blocks bands changes.
- 24) **D/I** - Switch between DDS/IF tuning modes.
Press the button to enable IF frequency tuning. The RX filter will move over the panorama, stations are fixed. IND1 indicates that the IF mode is switched on.
Press the button again to return to DDS tuning. The RX filter is fixed on the panorama, stations are moving.
- 25) **DOUBLE KNOBS - MON, SQL, TNF.P, TNF.W, MULTI 1.**

MON - Monitoring volume knob.

Rotate the knob to adjust the monitoring volume in the TX mode.

The knob is active only if the transceiver is in the TX mode and the MON button is pressed (more details in [Adjusting the Monitoring Gain](#)¹⁸⁶).

SQL - Squelch knob.

Rotate the knob to set the required squelch threshold.

It is convenient to control the squelch level using the S-meter yellow needle.

The knob will be active only if the SQL is enabled (more details in [Squelch level adjusting](#)¹⁸⁰).

TNF.P - Tunable Notch Filter Position.

Rotate the knob to set the position of the tunable notch filter in the RX filter band.

TNF.W - Tunable Notch Filter Width.

Rotate the knob to set the required width of the tunable notch filter in the RX filter band.

MULTI 1 - Knob for switching the categories in local panels.
Rotate the knob to select the required category in the local panel.

Note:

•If the local panel is open, then the *MON*, *TNF.P* functions will not be active. Close the local panel to operate these functions.

26) DOUBLE KNOBS - MIC, SPD, DRIVE, VOX, COMP.

MIC - Microphone gain control (in dB).

Rotate the knob to set required level of microphone gain.

The microphone gain level is displayed in the software Main window (more details in [Microphone gain control](#)¹⁸⁶).

Note:

•The gain factor is stored for each microphone (*MIC 1*, *MIC 2*, *MIC PC*).

SPD (SPEED) - CW speed knob (in WPM).

Rotate the knob to set the required speed of the CW signal manipulation.

The knob will be active only in CW mode. The set speed is displayed in the software Main window (more details in [Transmitting in CW mode](#)¹⁸⁸).

DRIVE - Drive knob (in %).

Rotate the knob to set the transceiver's output power.

The output power level is displayed in the software Main window (more details in [DRIVE level adjusting](#)¹⁸⁵).

VOX - VOX threshold knob.

Rotate the knob to set the required VOX threshold.

The knob is active only when the VOX mode is switched on (more details in [VOX](#)⁶⁵).

Note:

•*VOX* - voice activated TX mode (Voice-Operated Transmit).

COMP - Compression level knob.

Rotate the knob to adjust the compression level of the transmitting signal.

The knob is active only with SSB and AM voice modes (more details in [Compression](#)⁶⁵).

Note:

- The compression function increases the average output power, while decreasing the pick-factor of the TX signal.
-

27) DOUBLE KNOBS - AF, RF.

AF - AF Gain knob (LF gain).

Rotate the knob to set the required master volume level (more details in [Adjusting AF level](#)¹⁶⁹).

Note:

- The AF knob controls the volume of all receivers (RX1, RX2, VFO A, VFO B). You can set the volume separately for each of them in the MIXER local panel (more details in [MIXER](#)¹⁶²).
-

RF - RF Gain knob (receiver's AGC gain level).

Rotate the knob to adjust receiver's AGC gain level.

If the AGC is switched off, the knob will adjust the IF gain (more details in [Adjusting the RF gain](#)¹⁷⁰).

28) DOUBLE KNOBS - SHIFT, WIDTH, NB1, NB2, MULTI 2.

SHIFT - RX filter shift knob.

Rotate the knob to shift the RX filter relatively to the tuned frequency.

WIDTH - RX filter width knob.

Rotate the knob for adjusting the RX filter width.

The RX filter width is adjusted relatively to the filter's center.

NB1 - Noise Blanker 1 knob.

Rotate the knob to adjust the Noise Blanker 1 threshold (more details in [DSP Functions using](#)¹⁸⁰).

NB2 - Noise Blanker 2 knob.

Rotate the knob to adjust the Noise Blanker 2 threshold (more details in [DSP Functions using](#)¹⁸⁰).

MULTI 2 - Knob for adjusting parameters in the local panels.
Rotate the knob to adjust the selected parameter in the local panel.

Note:

•When a local panel is open, **SHIFT** and **NB1** knob functions will not be active. Close a local panel to continue operation with these functions.

29) **MIC(CW)** - Microphone inputs switch button / CW mode settings.

Press the button to select the microphone input (MIC 1, MIC 2, MIC PC).

The selected microphone is displayed in the Main window.

Press and hold the button to open the MIC/CW local panel (more details in [MIC/CW settings](#)^{□60}).

CMP - Voice signal compressor button.

Press the button to enable the voice signal compressor, press it again to switch off the compressor.

Press and hold the button to open the compressor's local panel (more details in [Compression](#)^{□65}).

Note:

•The compression function is available only for SSB and AM modes.

VOX - VOX button.

Press the button to enable the Voice-Operated Transmit system.

Press and hold the button to open the VOX local panel (more details in [VOX](#)^{□65}).

Note:

•VOX - voice activated TX mode (Voice-Operated Transmit)..

SQL - Squelch button.

Press the button to enable squelch.

Set the squelch threshold with the **SQL** knob on the transceiver's front panel (more details in [Squelch level adjusting](#)^{□180}).

R.EQ - RX mode equalizer.

Press the button to enable/disable the RX equalizer.

Press and hold the button to open the RX equalizer local panel (more details in [RX Equalizer](#)^{□64}).

Note:

•Tune the equalizer via the touch screen panel (by touching and moving the sliders), or use the **MULTI1** and **MULTI2** knobs.

T.EQ - TX processing module.

Press the button to enable/disable the TX equalizer.

Press and hold the button to open the TX processing module (more details in [Transceiver control panel](#)¹⁷¹ - **PROC** button).

IQ - IQ-files record button.

Press the button to record the IQ file, with bandwidth equal to sample rate.

Record mode is indicated in the Main window (more details in [IQ-files recording](#)¹⁸¹).

Attention!

Ⓢ **Continuous recording of IQ-files, could fill in all available free space on your SSD!**

XVTR - Transverter mode button.

Press the button to enable the transverter mode.

Note:

•**Transverter mode is not yet supported by the current version of the software. We plan to add it in the ExpertSDR2 1.3.**

STEP - Tuning step button.

Press the button to select the required frequency tuning step. The current step size is displayed in the Main window.

In Auto mode, the tuning step will change depending on the speed, the user rotates the Main knob (more details in [STEP changing](#)¹⁸²).

Z+ - Zoom in panorama.

Press **Z+** to zoom in the panorama (more details in [ZOOM-In ZOOM-Out the graphics](#)¹⁷⁹).

Note:

•**Zoom in of the panorama is carried out relatively to the blue triangle - zoom center marker.**

Z- - Zoom out panorama.

Press **Z-** to zoom out the panorama (more details in [ZOOM-In ZOOM-Out the graphics](#)¹⁷⁹).

Note:

•Zoom out of the panorama is carried out relatively to the blue triangle - zoom center marker.

WF - Wide Filter button.

Press the button to enable the wide RX filter with a 0...65 MHz width for HF and 95...150 MHz for VHF.

Note:

•The **WF** button will not function if the wide filter auto-enable mode is switched on.

30) **RIT** - Receive Incremental Tuning.

Press the button to enable the RX offset.

The offset of the receiver is adjusted with the **MULTI3** knob.

Press and hold the button to return the offset to zero (more details in [RIT/XIT Operations](#)¹⁹³).

XIT - Transmit Incremental Tuning.

Press the button to enable the TX offset.

Offset of the transceiver is adjusted with the **MULTI3** knob.

Press and hold the button to return the offset to zero (more details in [RIT/XIT Operations](#)¹⁹³).

RX2 - Second receiver button.

Press the button to enable the second receiver (more details in [RX2 Operation](#)¹⁹⁶).

Press the button to tune the second receiver frequency (see section 21).

31) **MULTI 3** - Multifunctional knob.

Rotate the **MULTI3** knob to tune the VFO B frequency in regular mode.

Rotate the **MULTI3** knob to tune the VFO A frequency in A/B mode.

Rotate the **MULTI3** knob to tune the offset frequency in RIT mode.

Rotate the **MULTI3** knob to tune the offset frequency in XIT mode.

4 REAR PANEL DESCRIPTION

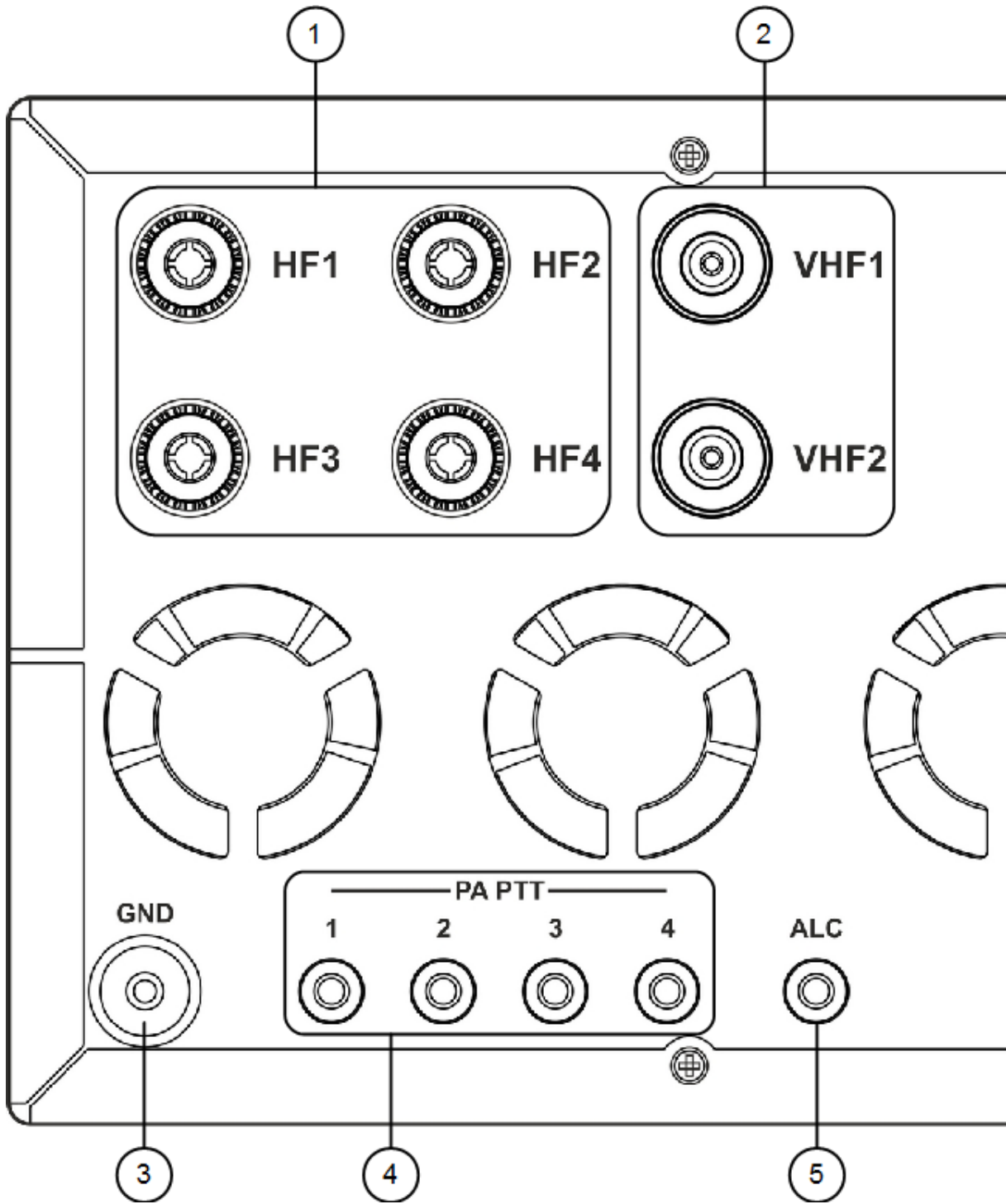

1) **HF1-HF4** - HF antenna connectors.

Connect RX and TX HF antennas to the **HF1-HF4** connectors. The antennas' impedance should be 50 Ohm.

You can switch between antenna connectors pressing the **ANT** button on the front panel of the transceiver when in HF mode (more details in [FRONT END](#)^{□57}).

Note:

• *Using antennas with impedance different from 50 Ohm, may worsen your RX and TX experience with the transceiver.*

2) **VHF1-VHF2** - VHF antenna connectors.

Connect RX and TX HF antennas to the **VHF1-VHF2** connectors. The antennas' impedance should be 50 Ohm.

You can switch between antenna connectors pressing the **ANT** button on the front panel of the transceiver when in VHF mode (more details in [FRONT END](#)^{□57}).

Note:

• *Using antennas with impedance different from 50 Ohm, may worsen your RX and TX experience with the transceiver.*

3) **GND** - Grounding/Earth terminal.

Use the **GND** terminal for grounding of the transceiver.

Attention!

① **Use only reliable grounding of transceiver to eliminate the risk of electric shock!**

4) **PA PTT 1-4** - PTT keys for switching external PAs in the TX mode.

Connect an external Power Amplifier to one of the **PA PTT** keys to let the transceiver switch it to the TX mode (more details in [Linear Amplifier](#)^{□21}).

5) **ALC** - Automatic Level Control.

Connect the **ALC** output of the Power Amplifier to this input for automatic control of the transceiver output power.

Input voltage range 0...-4 V.

Note:

• *ALC functionality is supported by the transceiver's hardware, but is not implemented in the ExpertSDR2 software. It will be supported in the ExpertSDR2 1.3.*

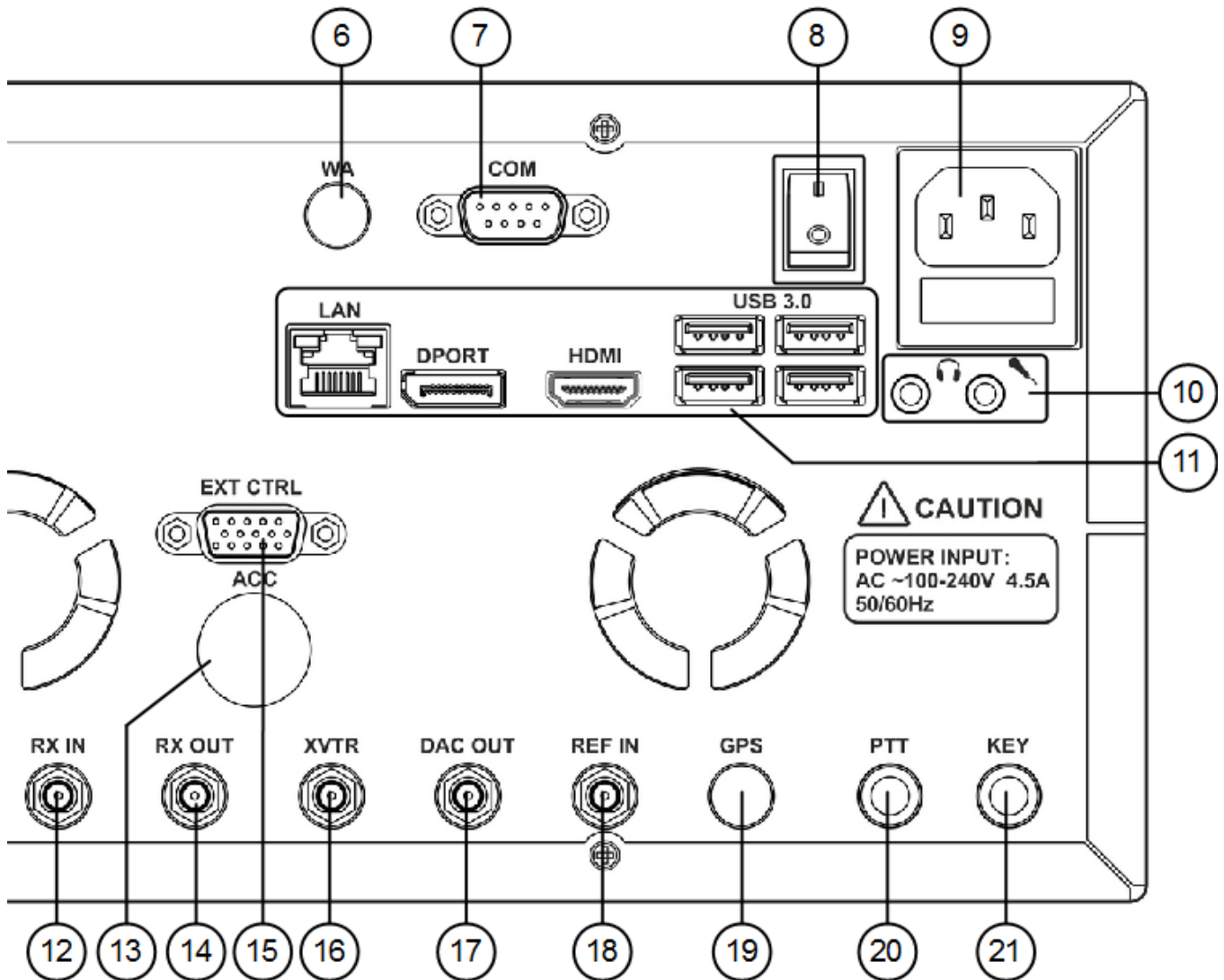

6) **WA** - Embedded WLAN module connector.
Is not available in current MB1 revisions.

7) **COM** - COM-port connector.
Connect external devices to the **COM-port** to control them (more details [Rear-Panel](#))^{D19}.

8) **I/O** - Power switch
Select the **I** position to power on the transceiver.

Note:

◆ *Make sure that the power switch is in **I** position, before pressing the power button.*

9) **Power socket.**

Connect the transceiver to the AC mains using the cable from the kit.
The supply voltage range is 100-240 V. Frequency 50/60 Hz. Current up to 4.5 A.
There is a 5A fuse installed in the power connector.

10) **MIC** - PC microphone input. Line-in.

Connect microphones to the internal PC's MIC input or use it as a **stereo line-in** input, applied signal level should be not higher than 1 Vp.

Headset - Headphone jack. Line-out.

Connect headphones or other audio devices to the output.

11) PC connectors panel.

LAN - LAN connector.

Connect the MB1 to local networks for remote operation of the MB1 and/or for internet access.

DPORT - Display Port for external monitor.

Connect an external monitor to extend the capabilities of your MB1.

HDMI - Connector for external monitor.

Connect an external monitor to extend the capabilities of your MB1.

Supports an HDMI display with 4K resolution.

USB 3.0 - Connectors for USB devices, USB 3.0 or lower.

Connect standard USB devices (mouse, keyboard, flash card, USB-COM-adapter, printer etc) to extend the capabilities of your MB1.

Warning!

① **Never connect VGA monitors to COM or ExtCTRL ports**

12) **RX IN** - Direct input of the receiver (high-speed ADC input).

Connect RX antennas, external filters, high-frequency amplifier, converters to the **RX IN** (more details in [RX IN and RX OUT](#)^{□25}).

13) **ACC** - Not active now.

14) **RX OUT** - RF output of the receive path.

Connect external filters, high-frequency amplifier etc to the **RX OUT** (more details in [RX IN and RX OUT](#)^{□25}).

15) **EXT CTRL** - Connector for external devices.

Connect to the **EXT CTRL** and control external power amplifiers, antenna connectors, band filters ([EXT CTRL devices](#)^{□22}).

16) **XVTR** - Connector for external transverters.

Connect UHF, SHF or other external transverters to the **XVTR** (more details in [XVTR](#)^{□24}).

17) **DAC OUT** - Linear output of the low power (up to 10 mW) signal generator.

Connect external power amplifiers and transverters to the DAC OUT (more details in [DAC OUT low power output](#)^{□25}).

Note:

• *Signals can be generated only on the amateur bands, in the frequency range 0.1-160 MHz.*

18) **REF IN** - External 10 MHz reference frequency input.

Connect an external reference oscillator with a 10 MHz frequency to the **REF IN** (more details in [Reference input](#)^{□23}).

19) **GPS** - Antenna input of the internal GPS receiver.

Is not available in current MB1 revisions.

20) **PTT** - PTT footswitch jack.

Connect a PTT footswitch to control the TX mode.

21) **KEY** - CW key jack.

Connect a CW key to the KEY jack.

The key can be a twin-paddle or a single-paddle key or a classic straight key (more details in [Accessories](#)^{□19}).

5 MAIN SCREEN DESCRIPTION

There is a touch screen display on the front panel of the MB1. On the screen you can see the ExpertSDR2 main window. You can control the software either with a mouse or with the touchscreen display.

5.1 MB1 GUI

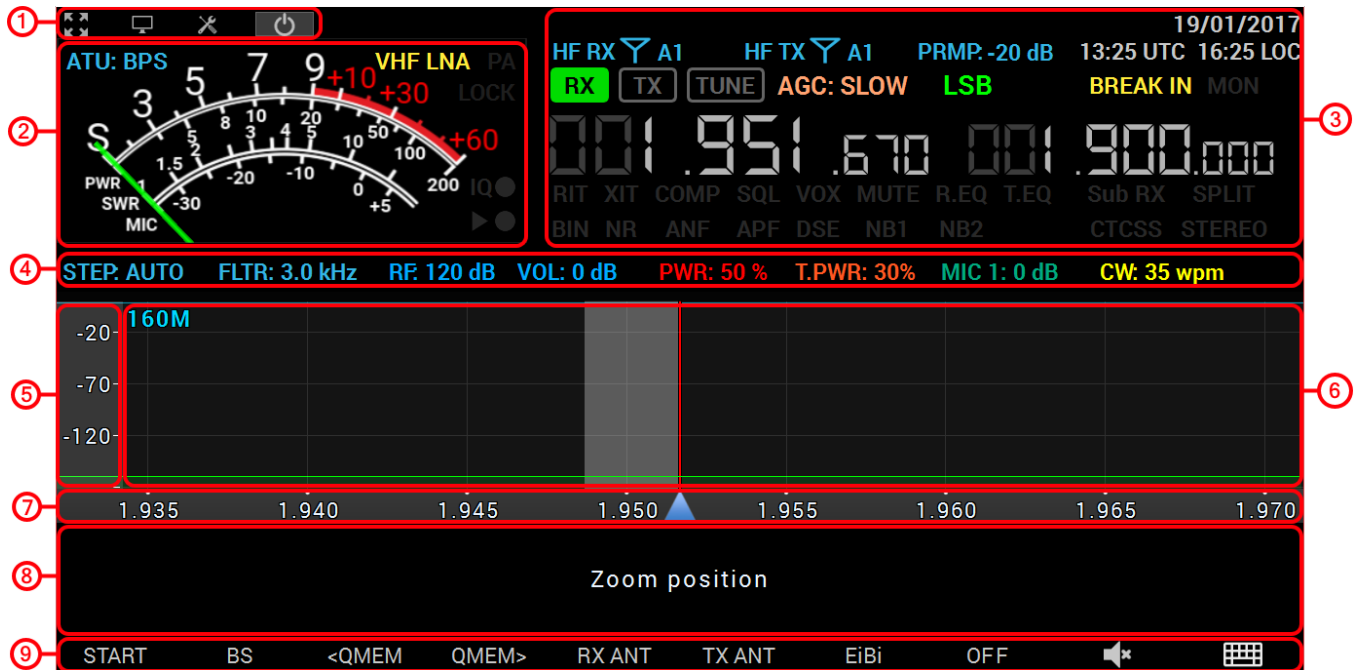

5.1.1 Section 1



- Full screen button.

Press the button to unroll the software window on the full screen, press it again to get back to standard size window.



- Switch view button.

Press the button to switch the ExpertSDR2 to Desktop (standard) view. We recommend to use an external display, at least 19" for this view.



- Options button.

Press the button to open the **Options** window.



- Software start button.

Press the button to start the software and begin to listen to the air.

Note:

- Auto-start is set by default after the launch of the software, no need to press the button.

5.1.2 Section 2

ATU: BPS - Automatic Tuner Unit (ATU or Tuner) mode indicator.

BPS - Bypass. Tuner is not used in TX or RX modes.

TX - TX mode. Tuner used in the TX mode.

RX - RX mode. Tuner used in the RX mode.

VHF LNA - VHF LNA (Low Noise Amplifier) mode indicator.

Enable the VHF LNA (the indicator is yellow if enabled), to additionally amplify the VHF signal with +22 dB gain.

PA - PTT keys indicator (PA).

If the PA indicator is red, then in the TX mode PTT keys will be active. Set the keys beforehand to let them operate (more details in [PA](#)¹⁰³).

LOCK - Frequency tuning locked indicator (LOCK).

If the LOCK indicator is orange, then the frequency tuning is impossible by any means (more details in [Frequency tuning LOCK](#)¹⁷⁶).

IQ - IQ-file record indicator (IQ).

If the IQ indicator is red - you are recording an IQ-file (more details in [IQ-files recording](#)¹⁸¹).

Warning!

① **IQ-files may require a huge amount of space! Continuous recording of IQ-files, could lead to using all available free disk space on your PC!**

 - Voice recorder play/record indicator.

If record indicator (circle) is red - you are recording a voice signal (more details in [Voice Recorder Operation](#)¹⁸⁷).

If play indicator (triangle) is green - you are playing a voice signal.



- S-meter/power meter.

S-meter/power meter displays the level of: RX signals, transceiver output power, SWR, Mic signal (more details in Meter).

5.1.3 Section 3

20/01/2017 - Current date indicator.

Displays current system date in DD/MM/YYYY format.

HF RX A1 - RX antenna switch/indicator.

It indicates and allows you to select the RX antenna (more details in [FRONT END](#)¹⁵⁷).

HF TX A1 - TX antenna switch/indicator.

It indicates and allows you to select the TX antenna (more details in [FRONT END](#)¹⁵⁷).

PRMP: 0 dB - Preamp switch/indicator.

It indicates and allows you to select the preamp level in the RX path from the drop-down menu (more details in [ATT PREAMP control](#)¹⁷⁴).

07:08 UTC 10:08 LOC - Current time indicator.

Displays current system time by the UTC and local standards.

RX - The RX mode switch/indicator.

If the indicator is green (as on the picture), then the MB1 transceiver is in the RX mode. If the transceiver is in any other mode, then the RX indicator will be dark-gray.

Press the RX button - with either the mouse cursor or via touch screen to turn the transceiver in the RX mode.

TX - The TX mode switch/indicator.

If the indicator is red (as on the picture), then the MB1 transceiver is in the TX mode. If the transceiver is in the RX mode, by pressing the TX button with either the mouse cursor or via touch screen you'll turn it to the TX mode.

TUNE - ATU switch/indicator.

If the indicator is red (as on the picture), then the MB1 is matching the transmitter and antenna impedance. To enable/disable this mode press the ATU switch/indicator with either the mouse cursor or via touch screen.

AGC: LONG - AGCs switch/indicator.

The AGC indicator shows the current AGC mode. Press this switch/indicator with either the mouse cursor or via touch screen to select the required AGC mode from the drop-down menu (more details in [AGC presets](#)¹⁷⁵).

USB - Mode switch/indicator.

The **MODE** indicator shows the current mode type. Press this switch/indicator with either the mouse cursor or via touch screen to select the required mode type from the drop-down menu (more details in [Operating modes choosing](#)¹⁷²).

BREAK IN - Break In switch/indicator.

If the BREAK IN indicator is yellow the transceiver will automatically turn to the TX mode by the press on the CW key. Press this switch/indicator with either the mouse cursor or via touch screen to enable/disable the Break In mode (more details in [MIC/CW settings](#)^{□60}).

MON - TX monitoring switch/indicator.

The MON indicator is blue if the monitoring is enabled. Press this switch/indicator with either the mouse cursor or via touch screen to enable/disable the monitoring in TX mode (more details in [Adjusting the Monitoring gain](#)^{□186}).

 - RX1 VFO A receiver frequency indicator.

 - RX1 VFO B receiver frequency indicator.

RIT - RIT switch/indicator (Receive Incremental Tuning).

The RIT indicator is blue if the RX offset is enabled. Press this switch/indicator with either the mouse cursor or via touch screen to enable/disable RX offset (more details in [RIT](#)^{□193}).

XIT - XIT switch/indicator (Transmit Incremental Tuning).

The XIT indicator is red if the TX offset is enabled. Press this switch/indicator with either the mouse cursor or via touch screen to enable/disable TX offset (more details in [XIT](#)^{□195}).

COMP - Transmitter compressor switch/indicator.

The COMP indicator is yellow if the transmitter compressor is enabled. Press this switch/indicator with either the mouse cursor or via touch screen to enable/disable transmitter compressor (more details in [Compression](#)^{□65}).

SQL - Squelch switch/indicator.

The SQL indicator is yellow if the RX squelch is enabled. Press this switch/indicator with either the mouse cursor or via touch screen to enable/disable RX squelch. (more details in [Squelch level adjusting](#)^{□190}).

VOX - VOX switch/indicator.

The VOX indicator is orange if the Voice-Operated Transmission is enabled. Press this switch/indicator with either the mouse cursor or via touch screen to enable/disable Voice-Operated Transmission (more details in [VOX](#)^{□65}).

MUTE - Mute switch/indicator.

The MUTE indicator is green if the RX volume is disabled. Press this switch/indicator with either the mouse cursor or via touch screen to enable/disable RX volume (more details in [Muting the received audio](#)^{□170}).

R.EQ - RX equalizer switch/indicator.

The R.EQ indicator is green if the RX equalizer is enabled. Press this switch/indicator with either the mouse cursor or via touch screen to enable/disable RX equalizer (more details in [RX equalizer](#)^{□64}).

T.EQ - TX equalizer switch/indicator.

The T.EQ indicator is orange if the TX equalizer is enabled. Press this switch/indicator with either the mouse cursor or via touch screen to enable/disable TX equalizer (more details in [Transceiver control panel](#)^{□71} - **PROC** button).

Sub RX - Sub-receiver switch/indicator.

The Sub RX indicator is blue if the sub-receiver is enabled. Press this switch/indicator with either the mouse cursor or via touch screen to enable/disable sub-receiver (more details in [Sub-receiver using](#)^{□193}).

SPLIT - SPLIT switch/indicator.

The SPLIT indicator is red if the split operation for the transmit frequency is enabled. Press this indicator/button with either the mouse cursor or via touch screen to enable/disable SPLIT (more details in [SPLIT operation](#)^{□191}).

BIN - Binaural mode switch/indicator.

Enable the BIN indicator (the indicator is green if enabled) to get a stereo-like effect in the RX filter. Press this switch/indicator with either the mouse cursor or via touch screen to enable/disable binaural mode (more details in [DSP functions using](#)^{□180}).

NR - Noise Reduction switch/indicator.

The NR indicator is orange if the RX noise reduction is enabled. Press this switch/indicator with either the mouse cursor or via touch screen to enable/disable the RX noise reduction (more details in [DSP functions using](#)^{□180}).

ANF - Automatic Notch Filter switch/indicator.

The ANF indicator is yellow if the RX automatic notch filter is enabled. Press this switch/indicator with either the mouse cursor or via touch screen to enable/disable the RX automatic notch filter (more details in [DSP functions using](#)^{□180}).

APF - Analog Peak Filter switch/indicator. APF creates a triangle AFC (amplitude-frequency characteristic) in the CW filter bandpass.

APF indicator is green if the analog peak filter is enabled. Press this switch/indicator with either the mouse cursor or via touch screen to enable/disable the analog peak filter (more details in [DSP functions using](#)^{□180}).

DSE - Digital Surround Effect for CW signals switch/indicator.

DSE indicator is blue light if the digital surround effect is enabled. Press this switch/indicator with

either the mouse cursor or via touch screen to enable/disable the digital surround effect (more details in [DSP functions using !\[\]\(34b4f260a8587d2e97eeaee361cc357b_img.jpg\)](#)).

NB1 - Noise Blanker 1 switch/indicator.

NB1 indicator is yellow if the RX noise blanker is enabled. Press this switch/indicator with either the mouse cursor or via touch screen to enable/disable the RX noise blanker (more details in [DSP functions using !\[\]\(6605b201d6f14d9b3bcb8ab5f274d107_img.jpg\)](#)).

NB2 - Noise Blanker 2 switch/indicator (different from the NB1).

NB2 indicator is yellow if the RX noise blanker is enabled. Press this switch/indicator with either the mouse cursor or via touch screen to enable/disable the RX noise blanker (more details in [DSP functions using !\[\]\(fa6f3af6bfa46c5d4a2d362681095beb_img.jpg\)](#)).

CTCSS - Continuous Tone-Coded Squelch System switch/indicator. In some cases, it's required to activate the squelch with the **CTCSS** tones. Set the **CTCSS** level relatively to your voice signal.

CTCSS indicator is yellow if the CTCSS is enabled. Press this switch/indicator with either the mouse cursor or via touch screen to enable/disable the CTCSS (more details in [CTCSS tones !\[\]\(e8fb589d58dad1692debababa5e928b6_img.jpg\)](#)).

STEREO - Stereo for WFM switch/indicator.

Enable the STEREO indicator (the indicator is green if enabled) when in the WFM mode to automatically detect whether the station is strong or not and listen to it in stereo mode. Press this switch/indicator with either the mouse cursor or via touch screen to enable/disable the STEREO mode.

5.1.4 Section 4

STEP: AUTO - Tuning step indicator for the **Main Knob** and **Multi 3** knob (more details in [Tuning STEP changing !\[\]\(4688aadfd656ded00cd6bdfae55089a9_img.jpg\)](#)).

FLTR: 3.0 kHz - Filter width indicator.

RF: 120 dB - Receiver AGC gain.

VOL: 0 dB - Global volume

PWR: 50 % - Output power level.

T.PWR: 30% - Power output in TUNE mode.

MIC PC: 20 dB - Current MIC and maximum gain indicator.

CW: 35 wpm - Speed of the CW signal being sent.

5.1.5 Section 5

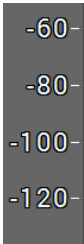

- Signal level scale in dBm for the RX mode and in dBV for the TX mode.

If you move the mouse cursor over the vertical scale a hand will appear. Press and hold the left mouse button (or touch the screen), then move it up/down to change the spectrum level or press and hold the right mouse button (or touch and hold on the screen), then move it up/down to change the dBm scaling.

5.1.6 Section 6

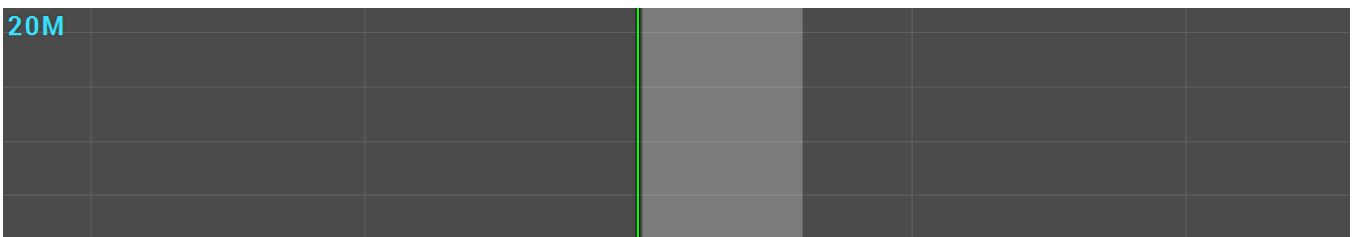

Spectrum scope window. In this window you can see the spectrum of the RX/TX signals: Amplitude - vertical, Frequency - horizontal.

To read more about the tuning process see [Frequency Tuning](#)¹⁶⁷.

20M - Amateur band indicator.



- Filter width is semitransparent. Vertical green line is a tuned frequency.

5.1.7 Section 7

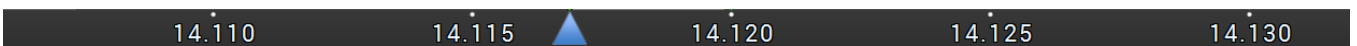

Horizontal frequency scale between the spectrum scope and waterfall shows the frequency of the certain point on the spectrum. If you move the mouse cursor over the horizontal scale a hand will appear. Press and hold the left mouse button (or touch the screen), then move it up/down to change the ratio of the spectrum to waterfall or press and hold the right mouse button (or touch and hold on the screen), then move it left/right to zoom in/out the panorama.



- Zoom position. Spectrum scope and waterfall are zoomed in or out in respect to this marker (more details in [ZOOM-in ZOOM-out the graphics](#)¹⁷⁹).

You can change the Zoom position in two ways:

1. Press and hold the left mouse button on the Zoom marker and drag it left/right,
2. Click the mouse wheel on frequency scale.

5.1.8 Section 8

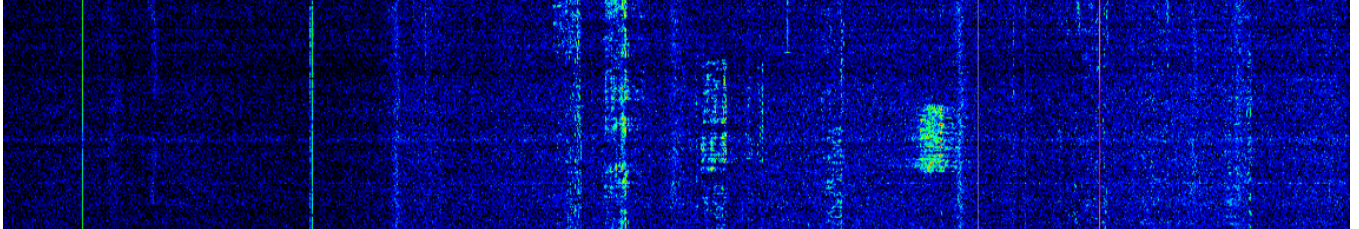

Waterfall - Timed spectrum scope in format: Amplitude - Brightness, frequency - horizontal, time - vertical.

5.1.9 Section 9



Settings panel for the F1-F10 functional buttons (more details in [Functional buttons using ¹⁸³](#)).

5.2 Local panels

Local panels display the main transceiver settings.

Press and hold the corresponding button on the transceivers front panel to open a local panel, it will be displayed over the waterfall graphic.

Press and hold the button again to close a local panel or close it by the click on the cross in the top, right corner of the local panel with either the mouse cursor or via touch screen.

Note:

•Local panels are available only in the ExpertSDR2-MB1 style. In the Desktop style local panels are not available. You can find the required settings in the Options menu.

5.2.1 ATU

Press and hold the **TUN** button on the front panel of the transceiver to open/close the local panel.

Automatic Tuner Unit (ATU) works on HF frequencies, it allows to match a load impedance with SWR up to 5 (approximate impedance range from 15 till 300 Ohm), with the 50 Ohm transmitter impedance.

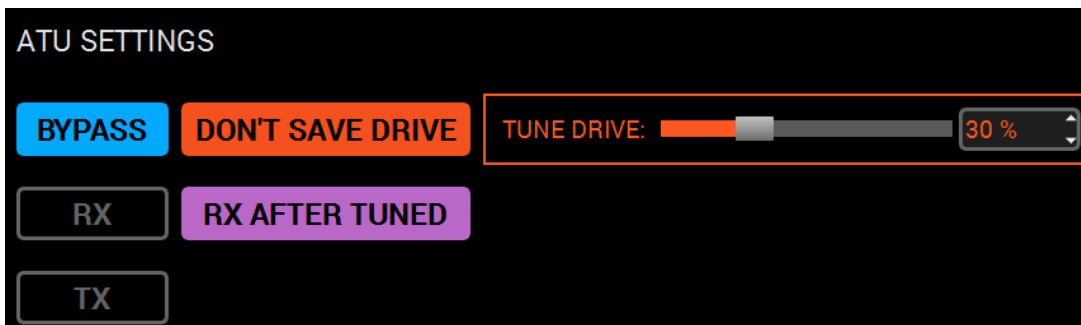

BYPASS - Tuner's bypass mode.

Press the button to enable the tuner's bypass mode, in other words to eliminate it from the signal path.

RX - Enable the Tuner for the RX mode.

Press the **RX** button to enable matching in the RX mode.

Note:

•The Tuner cannot match in the RX mode. The Tuner can use only earlier saved states from the TX mode.

TX - Enable the Tuner for the TX mode.

Press the **TX** button to enable matching in the TX mode.

DON'T SAVE DRIVE - Disables saving of the **Drive** level per band and mode.

Note:

•If the checkbox is not set, **Drive** level is memorized for the frequency bands and mode types. Tone level is memorized only for the frequency bands.

TUNE DRIVE - Tone **Drive** level in TUNE mode.

RX AFTER TUNED - Turn to RX after matching.

Press the **RX AFTER TUNED** button and the transceiver will turn to the RX mode after the tuner is matched.

ATU operation:

Enable the Tuner in the **ATU SETTINGS** local panel to use it in the TX mode.

1. Press and hold the **TUN** button on the front panel of the transceiver to call up the local panel.
2. Press the **TX** button in the local panel - it will activate the Tuner in the TX mode.
3. Press and hold the **TUN** button or press "X" in the panel top right corner to close the panel.

4. Short press the **TUN** button on the front panel of the transceiver, will activate orange LED above the TUN button.

Transceiver will turn to TX mode, begin to transmit carrier frequency 15-20 W and tune.

5. After the tuning, transceiver will disable the tuning mode - orange LED above the TUN button will be deactivated.

6.a. If the **RX AFTER TUNED** button is enabled, the transceiver will turn to RX mode after tuning.

6.b. If the **RX AFTER TUNED** button is disabled, the transceiver will stay in TX mode after tuning.

Warning!

- ① Tuner's states are saved with 50 kHz step! e.g. in sections 7.0-7.05; 7.05-7.1; 7.1-7.15 etc. ATU will have the same setting for all frequencies.
- ① At the moment ATU settings ARE NOT stored per each antenna connector.
- ① Watch for the Tuner and SWR readings, if you need to operate on the new frequency (you've never tuned on) - perform the tuning again!

5.2.2 DSP SETTINGS

Press and hold the **DSP** button on the front panel of the transceiver to open/close the local panel.

List of buttons on the front panel to open DSP local panel: **NR**, **ANF**, **TNF**, **BIN**, **NB1**, **NB2**.

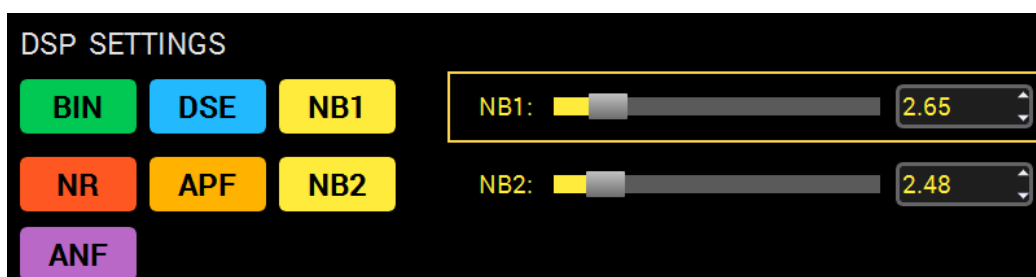

BIN - Binaural mode button.

Press the **BIN** button to enable binaural mode. The phasing of the audio signal within the RX filter gives a stereo-like effect.

DSE - Digital Surround Effect in CW.

Press the **DSE** button to enable Digital Surround Effect (more details in [DSP functions](#)^{D180}).

NB1 - First Noise Blanker.

Press the **NB1** button to enable the first Noise Blanker (more details in [DSP functions](#)^{D180}).

NB1 slider - NB1 trigger threshold. Set the required trigger threshold, depends on the interference level.

NR - Noise reduction.

Press the **NR** button to enable receiver's noise reduction (more details in [DSP functions](#)¹⁸⁰).

APF - Analog Pick Filter button. APF creates a triangle AFC (amplitude-frequency characteristic) in the CW and SSB filter bandpass.

Press the **APF** button to enable the Analog Pick Filter (more details in [DSP functions](#)¹⁸⁰).

NB2 - Second Noise Blanker.

Press the **NB2** button to enable the second Noise Blanker (more details in [DSP functions](#)¹⁸⁰).

Note:

- The **NB1** and **NB2** algorithms are different. Try each of them to reach the best impulse interference reduction.
- NB1** and **NB2** Noise Blankers can also be used simultaneously.

NB2 slider - NB2 trigger threshold. Set the required trigger threshold, depends on the interference level.

ANF - Automatic Notch Filter.

Press the **ANF** button to enable an automatic reduction of the narrowband noises in the filter bandwidth (noises, carriers, CW signals etc.).

Note:

- If there are no interferences, **ANF** could slightly affect the reception quality of the desired signal. Disable **ANF**, if you don't need it.

5.2.3 FRONT END SETTINGS

Press and hold the **ANT** or **ATT** button on the front panel of the transceiver to open/close the local panel.

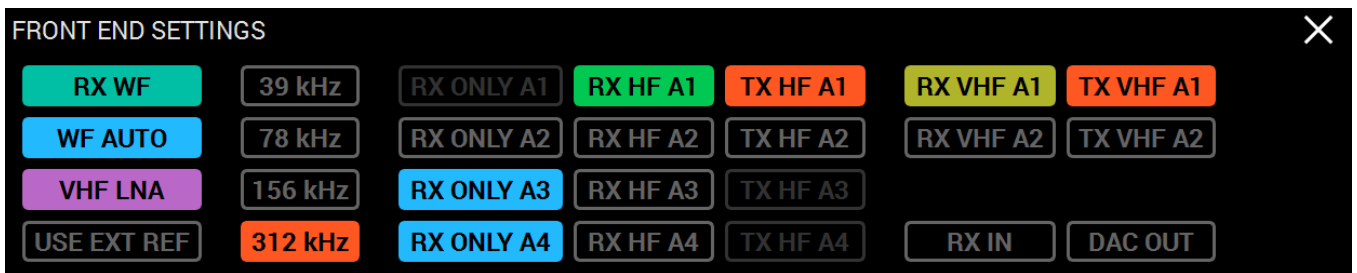

RX WF - Wide Filter button.

Press the **RX WF** button to enable the wide filter for all HF band (0...65 MHz) or VHF band (95...155 MHz) - receiver automatically selects HF or VHF, depending on the tuning frequency.

WF AUTO - Auto enable the Wide Filter.

Press the **WF AUTO** button to let the wide filter to be enabled automatically, when you use Band-Scope and/or the RX2 on the other band.

Note:

•If the **WF AUTO** mode is enabled, then the **WF** button won't function.

VHF LNA - VHF LNA button.

Press the button to enable Low Noise Amplifier for the VHF band. It is disabled automatically when you turn to the HF band.

USE EXT REF - REF input button.

Press the button to use a 10 MHz external oscillator as the reference oscillator, to improve frequency stability.

Receiver's sample rate:

39 kHz - 39 kHz sample rate button.

78 kHz - 78 kHz sample rate button.

156 kHz - 156 kHz sample rate button.

312 kHz - 312 kHz sample rate button.

Receiver's sample rate influences panorama's bandwidth and quadrature's bandwidth, which could be transferred to the CW Skimmer.

RX ONLY A1...A4 - "RX only" mode for the HF antennas.

Press the **RX ONLY Ax** button in front of the required antenna input. Selected antenna input will be used only for RX, TX with it is impossible.

Note:

•You can set the **RX ONLY** mode for three antennas at max. One antenna should be assigned for the TX mode.

•You cannot transmit with **RX ONLY** antennas.

RX HF A1...A4 - Receive antenna for the HF band.

Press the **RX HF Ax** button to select the receive antenna for the HF band (more details in [Antenna switch](#)¹⁸²).

TX HF A1...A4 - Transmit antenna for the HF band.

Press the **TX HF Ax** button to select the transmit antenna for the HF band (more details in [Antenna switch](#)¹⁸²).

RX VHF A1..A2 - Receive antenna for the VHF band.

Press the **RX VHF Ax** button to select the receive antenna for the VHF band (more details in [Antenna switch](#)¹⁸²).

TX VHF A1..A2 - Transmit antenna for the VHF band.

Press the **TX VHF Ax** button to select the transmit antenna for the VHF band (more details in [Antenna switch](#)¹⁸²).

RX IN - Receiver direct input button.

Press the **RX IN** button to enable the receiver direct input which can be used with receive antennas, external filters and UHF converters.

The **RX IN** is connected directly to the ADC input, by-passing band filters.

When you enable the **RX IN** you automatically enable the **RX OUT** - the receiver's HF path output (through band filters, attenuators), which also can be used with additional external filters, UHF converters etc.

DAC OUT - 10 mW low-power output button.

Press the **DAC OUT** button to enable transceiver low-power output.

Low-power output frequency range is 100 kHz-160 MHz (more details in [DAC OUT operation](#)¹⁸⁹).

5.2.4 Manual frequency input

Press and hold the **ENT** button on the front panel of the transceiver to open/close the local panel. Short press on the **ENT** button to apply the entered frequency to the VFO A.

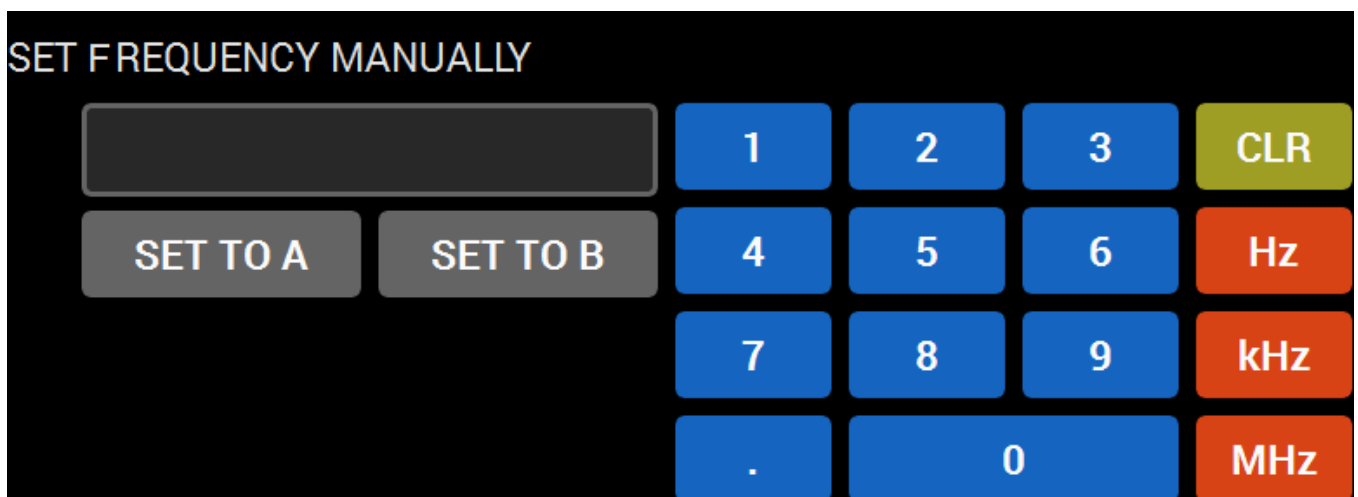

Enter the required frequency either with touchscreen or with physical buttons on the front panel, then apply the entered frequency either to VFO A (SET TO A) or to VFO B (SET TO B).

5.2.5 MEMORY PANEL

To open the **MEMORY PANEL** press the **M.RD** button on the MB1 front panel or press and hold the **M.IN** button.

To close the **MEMORY PANEL** press and hold the **M.RD** button.

MEMORY PANEL

	Frequency	Mode	Comment
1	3 610 989.0 Hz	LSB	entry 2
2	18 118 000.0 Hz	USB	entry 1
3	28 871 272.0 Hz	USB	entry 4
4	29 001 512.0 Hz	USB	entry 3

To quickly add the VFO A frequency and mode type to the **MEMORY PANEL**, press the **M.IN** button, then add the comment.

To tune on the saved frequency:

- 1) Open the **MEMORY PANEL**
- 2) Select the required frequency with the **MULTI 1** knob
- 3) Press the **M.RD** button.

To delete a saved frequency, activate the **SHIFT** mode, it will make the **DEL (NB1)** function available and then delete the required frequency.

5.2.6 MIC/CW SETTINGS

Press and hold the **MIC** button on the front panel of the transceiver to open/close the local panel.

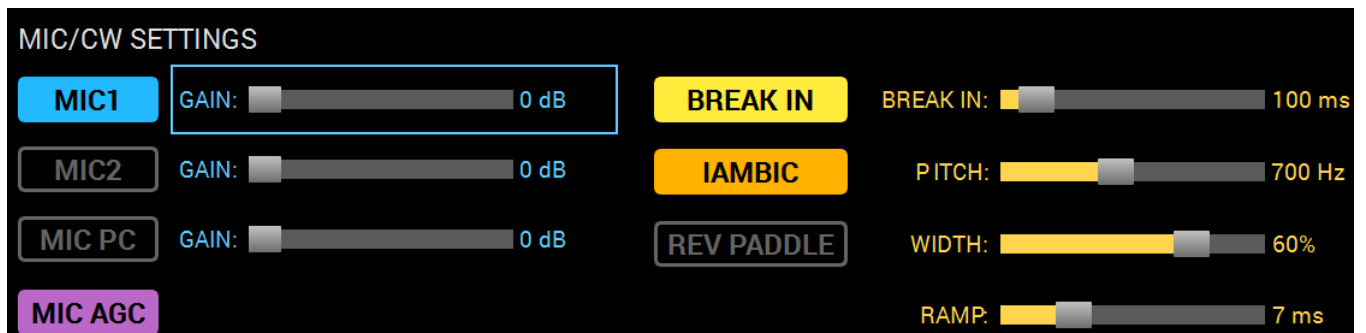

Press the **MIC** button on the the front panel of the transceiver to select the required microphone input **MIC1**, **MIC2**, **MIC PC**.

- **MIC1** - Electret input / linear input.
- **MIC2** - Dynamic input.
- **MIC PC** - Sound card input.

The active microphone is displayed in the software Main window - **MIC PC: 20 dB** there you can see the current level of the microphone AGC gain.

Note:

•Max microphone AGC gain is stored for each microphone input separately.

MIC1 - MIC 1 button.

Press the **MIC1** button to select the corresponding microphone.

MIC1 GAIN - Microphone gain.

Set the required gain level of the microphone input. If the Mic AGC is enabled, the slider sets the max microphone's AGC gain.

MIC2 - MIC 2 button.

Press the **MIC2** button to select the corresponding microphone.

MIC2 GAIN - Microphone input gain control.

Set the required gain level of the microphone input. If the Mic AGC is enabled, the slider sets the max microphone's AGC gain.

MIC PC - PC's sound card MIC.

Press the **MIC PC** button to select the PC's microphone.

MIC PC GAIN - Microphone input gain control.

Set the required gain level of the microphone input. If the Mic AGC is enabled, the slider sets the max microphone's AGC gain.

MIC AGC - Microphone gain control.

Press the **MIC AGC** button to enable the MIC AGC. It automatically detects the required gain level, but does not exceed the set threshold.

For fine tuning of the PC microphone's AGC open the [Mic^{D95}](#) tab.

CW settings:

BREAK IN - CW VOX mode.

Press the **BREAK IN** button to enable this mode - transceiver will automatically turn to the TX mode by the press on the CW keyer.

IAMBIC - Automatic dots and dashes generation.

Press the **IAMBIC** button to enable automatic generation of the CW signal.

If the **IAMBIC** mode is off, while you press the CW keyer it will generate tone signal with PITCH frequency.

REV PADDLE - Reverse dots and dashes.

Press the **REV PADDLE** button to switch dots and dashes in reverse order on your CW keyer.

BREAK IN DELAY (ms) - Time to keep the transceiver in the TX mode.

Set the required time for the transceiver to hold in the TX mode, after you let go of the CW keyer.

PITCH (Hz) - CW signal's tone frequency.

Set the required CW signal's tone frequency (also used for the RX mode).

WIDTH (%) - Dot-to-pause ratio.

Width value 50, means that Dot equals pause in length. Dash always equals 3 Dots.

RAMP (ms) - CW signals' slope length.

Set the required CW signals' slope length. The higher the manipulation speed the shorter should be slopes.

5.2.7 MIXER

Press and hold the **MUT** button on the front panel of the transceiver to open/close the local panel. The MB1 has two audio generators: the SDR-module and internal PC.

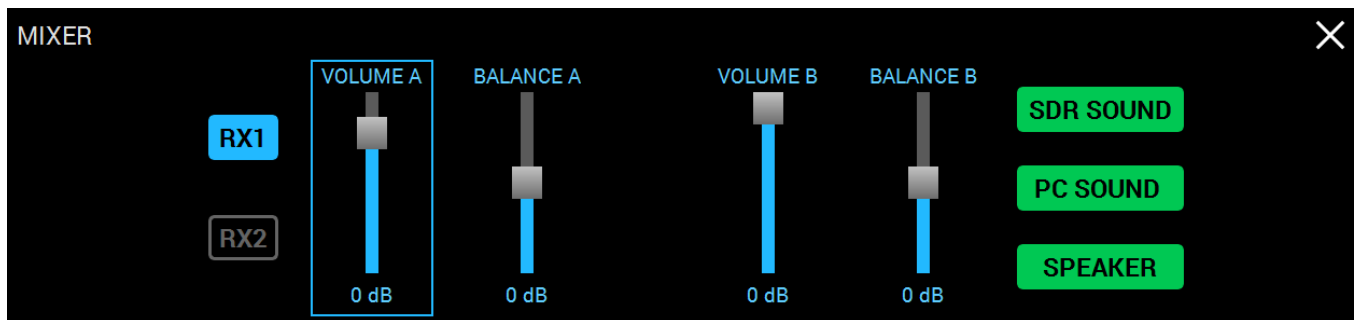

Description of controls and routing of audio signals from the **SDR-module**:

RX1 - Enable the RX1 controls.

Press the **RX1** to enable volume and balance control for VFO A, VFO B of the RX1.

RX2 - Enable the RX2 controls.

Press the **RX2** to enable volume and balance control for VFO A, VFO B of the RX2.

VOLUME A - VFO A volume control.

BALANCE A - VFO A volume balance between left and right channels.

VOLUME B - VFO B volume control.

BALANCE B - VFO B volume balance between left and right channels.

Note:

•Described volume and balance settings are active only when the sub-receiver is enabled. If you use only VFO A (the sub-receiver is disabled) then you change the global volume.

SDR SOUND - Audio output from the transceiver.

Press the **SDR SOUND** to listen to the transceiver's RX signals.

PC SOUND - Audio output from the PC.

Press the **PC SOUND** to listen to the audio from PC, e.g. audio, video files, web browsing, SKYPE etc.

Internal PC volume can be adjusted with the mouse and standard Windows controls or with the special functional buttons (the example of the special buttons below).



SPEAKER - Audio output from the speaker.

Press the **SPEAKER** to listen to the audio from the speaker.

Note:

- The load speaker is active only if the **SPEAKER** button is pressed. It doesn't matter whether the headphones are plugged in the **PHONES** jack or not.
- There is a constant audio output on the **PHONES** jack, **SPEAKER** button state doesn't matter.

5.2.8 NFM-SETTINGS

Press and hold the **MD** or **MU** mode button on the front panel of the transceiver to open/close the local panel.

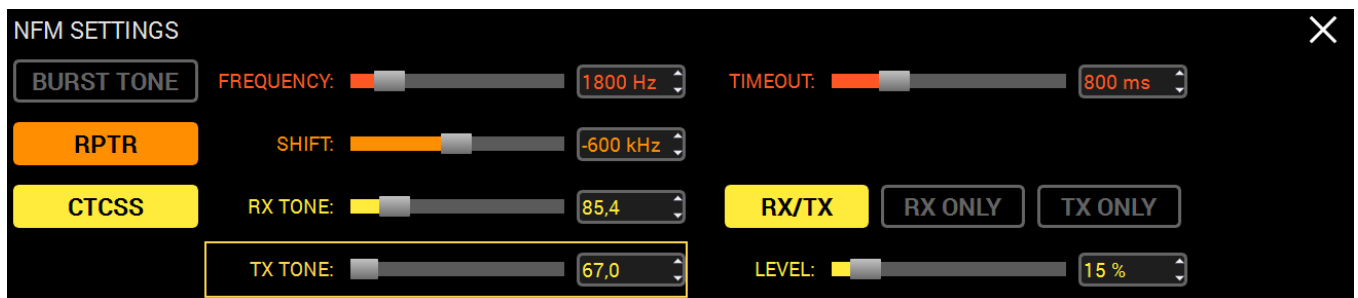

BURST TONE - Transmit tone for repeater.

Press the **BURST TONE** button to transmit tone signal, which will open the repeater - "wake it up".

FREQUENCY - Tone frequency slider.

Set the tone frequency with the **FREQUENCY** slider or enter the required number from the keyboard in the input box.

TIMEOUT - TX tone timeout.

Set the required TX time to transmit the tone signal with the **TIMEOUT** slider.

RPTR - Repeater mode button.

Press the **RPTR** button to enable repeater mode.

SHIFT - Repeater shift slider.

Set the frequency shift with the **SHIFT** slider or enter the required number from the keyboard in the input box.

CTCSS - CTCSS tone mode.

Press the **CTCSS** button to enable the CTCSS tone mode.

RX TONE - CTCSS tone RX frequency slider.

Set the RX tone frequency with the **RX TONE** slider or enter the required number from the keyboard in the input box.

TX TONE - CTCSS tone TX frequency slider.

Set the TX tone frequency with the **TX TONE** slider or enter the required number from the keyboard in the input box.

RX/TX - CTCSS mode for both RX and TX.

Press the **RX/TX** button to enable CTCSS tone for both RX and TX.

RX ONLY - CTCSS mode only for RX.

Press the **RX ONLY** button to enable CTCSS tone only for RX.

TX ONLY - CTCSS mode only for TX.

Press the **TX ONLY** button to enable CTCSS tone only for TX.

LEVEL - Tone level slider.

Set the CTCSS tone level with the **LEVEL** slider or enter the required number from the keyboard in the input box. By default 15%.

5.2.9 PROFILES

To open the **PROFILES** local panel, assign it on any of the F1-F10 programmable buttons (displayed as PROF.).

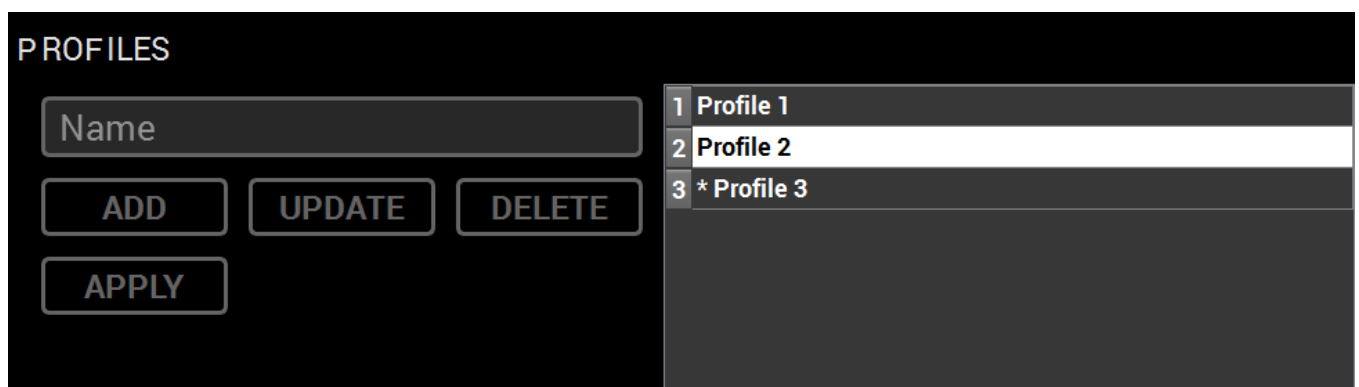

To **ADD** a new Profile, enter a Profile name in the "Name" field and press the **ADD** button or **Enter** on the keyboard.

To enable the Profile, select the required Profile from the list with the **Multi1** knob and press the **APPLY** button.

To **DELETE** the Profile, select the required Profile from the list and press the **DELETE** button.

If you want to **UPDATE** the Profile state, then press the **UPDATE** button.

The active Profile is marked with "*".

5.2.10 RX EQUALIZER

Adjust the **18-band RX Equalizer** in the **RX Equalizer** local panel. Press and hold the **R.EQ** button on the front panel of the transceiver to open/close the local panel.

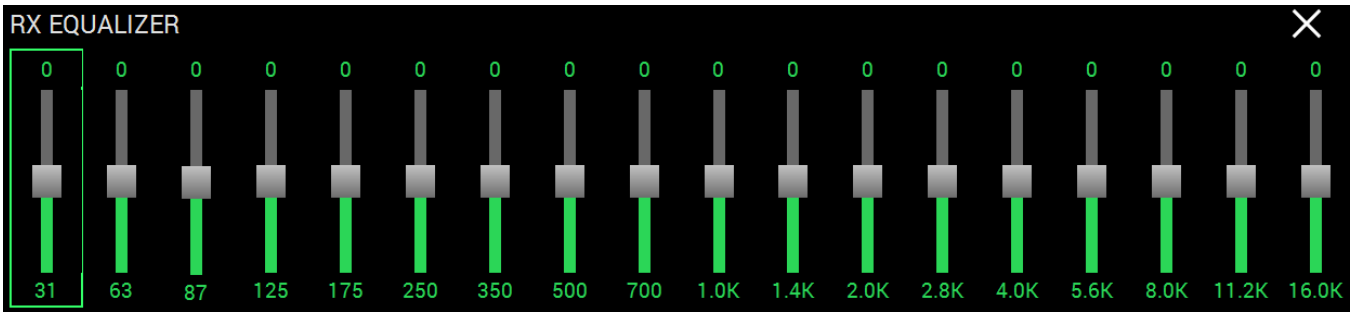

By rotating the **Multi 1** knob, select the band you want to adjust - marked with the green rectangle.

By rotating the **Multi 2** knob set the required level for each band.

Note:

- Adjust the Equalizer level with a mouse, by dragging the sliders up and down.
- Also you can adjust the Equalizer level with the transceiver's touch-screen panel, by dragging the sliders up and down with your finger.

5.2.11 VOX/COMPRESSOR SETTINGS

Press and hold the **CMP/VOX** button on the front panel of the transceiver to open/close the local panel.

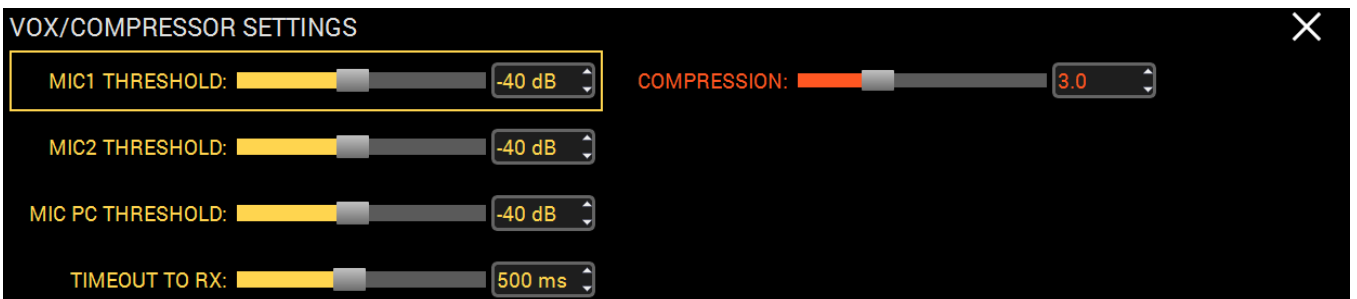

MIC1 THRESHOLD, MIC2 THRESHOLD, MIC PC THRESHOLD - VOX system trigger thresholds.

Set the VOX trigger threshold for the corresponding microphone according to the noise level in the room.

Note:

- Enable the **VOX** by pressing the **VOX** button on the front panel of the transceiver.
- **VOX functionality:** it turns the MB1 in the TX mode when you speak in a microphone. **VOX - Voice-Operated Transmit.**
- Threshold level is set and memorized for each microphone separately.

TIMEOUT TO RX - TX to RX delay after the VOX is off.

Set the required delay time to switch from TX to RX for comfortable operation on the air.

COMPRESSION - TX signal compression.

Set the required compression level for the transmitted signal.

Note:

- The higher the compression level the higher the average power of the voice signal.
- Check the quality of the TX signal with TX monitoring function! Excessive **COMP** level may worsen the signal quality!
- With disabled compressor pick-factor of the voice signal equals 3. That means average/actual power of the voice signal will be 3 times less than the pick values of this signal. In practice it is expressed as slight deviation of the transceiver's power meter needle. It's approximately 30W with max power output. Compressor purpose is to lower the pick-factor, by increasing the compression of the signal, thus increasing the average/actual power. Power meter needle will deviate more.

5.3 Desktop GUI

Here is how the **Desktop** style looks like

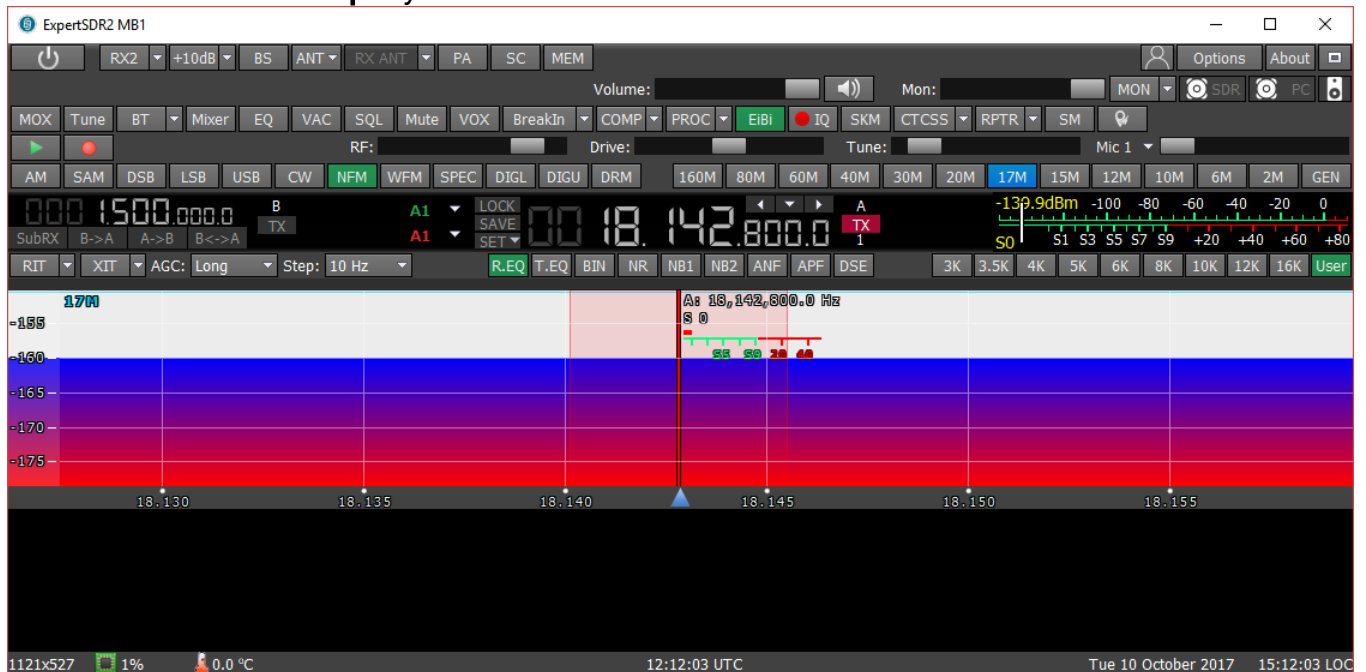

5.3.1 Global controls panel

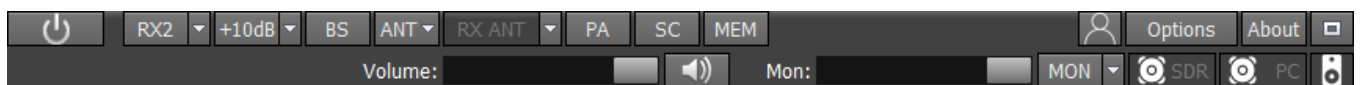

This panel consists of the following buttons:

-  - the **Start** button switches on/off the ExpertSDR2 software.



- enable/disable button of the second software receiver (**RX2**).

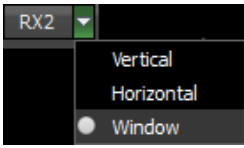

- In the **RX2** drop-down menu, you can select receiver's window configuration.

RX2 window has the same interface as the **RX1**.

Note:

•Two independent software receivers can operate simultaneously only in one Nyquist zone 0-80 MHz or 80-160 MHz.

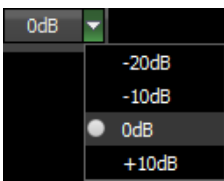

- **Attenuator** level can be set via the drop down menu or by successive presses of the indicator button, which cycles upwards the attenuation coefficient in the following order: -20dB, -10dB, 0dB, +10dB.

Note:

•While using Band Pass Filters (BPFs), the attenuator and the preamplifier values are stored for each filter and each band accordingly. When the Low Pass Filter (LPF) is enabled for the whole HF band, its attenuator/preamplifier level is already stored.

•When you use BPFs along with the **RX2**, the filters are controlled by the **RX1**.

•**Attenuator specifics:** S-meter values and audio level have program compensation when you use the attenuator because signal level on the antenna input is always the same and doesn't depend on the attenuator level. With this solution, a user doesn't need to calculate real values on his own, every time when the -20 dB attenuator is used. Also, he doesn't need to adjust AF or RF level every time when the -20 dB attenuator is used, like in most classic transceivers.

Attenuator influences only receiving dynamic range, S-meter and audio level stay the same. If you disconnect antenna you can see how receiver's noises are changing when you switch the ATT. Receiver's noise level is lower when you select ATT 0 dB, it means that RX sensitivity is higher, but RX noise level is higher when you use ATT -20 dB, it means that RX sensitivity is worse. It is done in the hardware.



- enable/disable the wide **bandscope** in the same Nyquist zone as the **RX1**, from 0 to 80 MHz or from 80 to 160 MHz (**BS**).

When you use the **bandscope**, Band Pass Filters are still active, to use the WideRX filter (0-65

MHz or 95-155 MHz) set the **Use wide RX filter** checkbox or **Auto enable** checkbox (it will turn the Wide RX filter automatically) in the Options > Device menu.

The **bandscope** window can be either adjusted inside the ExpertSDR2 window or can be displayed as the separate window on the second monitor. Navigation and settings of the **bandscope** are similar to the panorama settings of the main receiver.

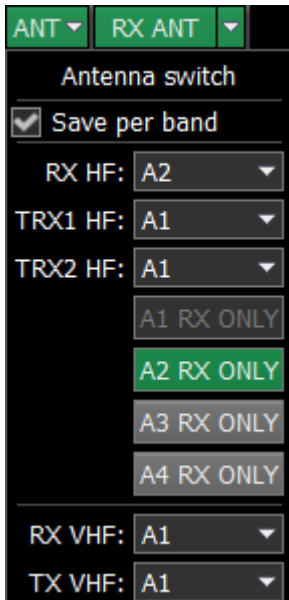

Antenna switch menu. This menu allows you to lock the required HF/VHF antenna input **only for RX**. When the certain HF/VHF antenna input is locked for RX you cannot select it for TX.

For more details on the [antenna switch](#)¹⁸² operation.

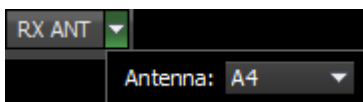

RX ANT button enables receiving on the selected antenna input, which is selected in the drop-down menu. You cannot select the antenna input as **RX ONLY** if it's selected for TX.

PA - enable/disable an external power amplifier (**PA**).

SC - enable/disable sound output from the PC's sound card (**SC**). It doesn't prevent sound output from the front panel, it duplicates output from the PC's sound card.

MEM - enable/disable button of the frequency memory panel (**MEM**).

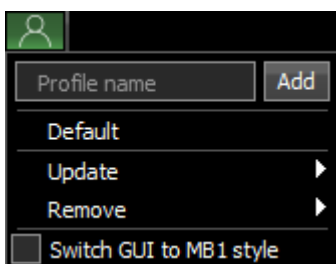
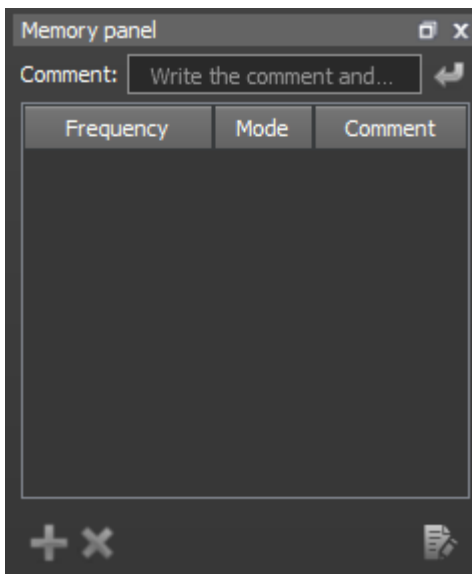

- In the **Profile** manager menu you can:

- add a new profile, by entering the name of the profile in the “Profile name” field and pressing **Add** button.
- set the settings of the whole program to the default state, by the **Default** button.
- **Update** the settings of the certain profile from the list to the current settings.
- **Remove** the certain profile from the list.

Note:

- *All new profiles will be stacked up to the drop-down menu as a new line.*
-

Switch GUI to MB1 style - Press this checkbox to switch to the MB1 GUI.

Options - **Options** menu described [options](#)⁹³.

About - **About** button opens the new window with the info about current version of the ExpertSDR2 software:



 - pressing the **Fullscreen** mode button will unfold the software window on the whole screen.

 - **Volume** slider. This setting is stored per band, it affects the LF output on the transceiver's front panel and PC's sound card output. Speaker icon has the mute function.

 - **Mon** volume slider. Press the **MON** button to enable the monitoring. This function allows you to listen to the generated signal and control its quality.

Note:

• *An excessive monitoring volume may lead to the positive acoustic connection between the microphone and headphones and as a result to the self-triggering of the audio path.*

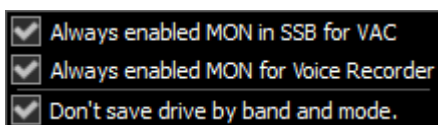

- Even if the **MON** button is switched off, it is possible to enable the following functions from the drop-down menu:

Always enabled MON in SSB for VAC: if the audio record is transmitted in SSB via VAC, the self-control will be enabled.

Always enabled MON for Voice Recorder: if the voice recorder is transmitting the audio record, the self-control will be enabled.

Don't save drive by band and mode: disables saving of the **Drive** level per band and mode.

Note:

• *If the checkbox is not set, **Drive** level is memorized for the frequency bands and mode types. **Tone** level is memorized only for the frequency bands.*

 - Audio output menu

SDR SOUND - Audio output from the transceiver.

Press the **SDR SOUND** to listen to the transceiver's RX signals.

PC SOUND - Audio output from the PC.

Press the **PC SOUND** to listen to the audio from PC, e.g. audio, video files, web browsing, SKYPE etc.

SPEAKER - Audio output from the speaker.

Press the **SPEAKER** to listen to the audio from the speaker.

5.3.2 Software transceiver settings

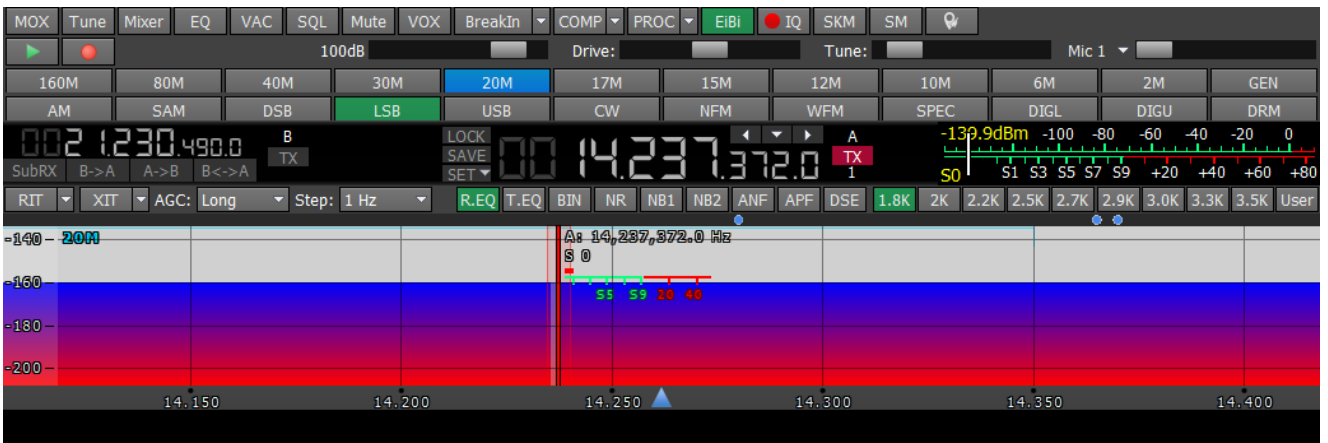

These settings are divided into four logical parts, described below.

5.3.2.1 Transceiver control panel

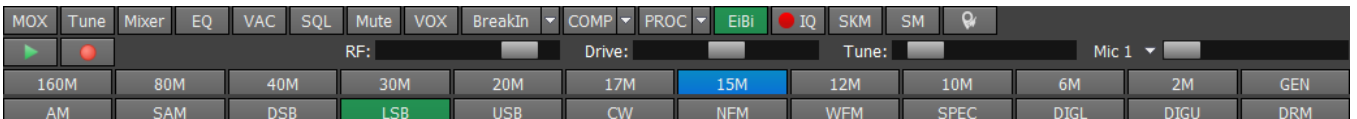

 - enable/disable manually operated transmit mode (**MOX**).

 - enable/disable tone (carrier) signal in TX mode, the output power can be adjusted by the **Tone** slider (**Tune**).



 - volume and balance control menu for the first and second receivers separately (**Mixer**). When you use only RX1, the Mixer settings are off, but when you enable the RX2, it activates Mixers for both RXs.

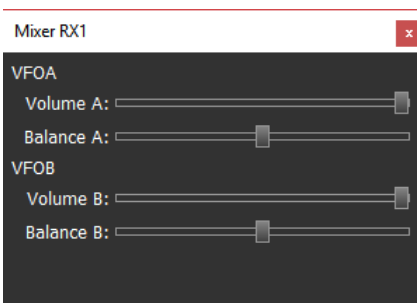

 - open the 18-band RX equalizer menu (**EQ**).

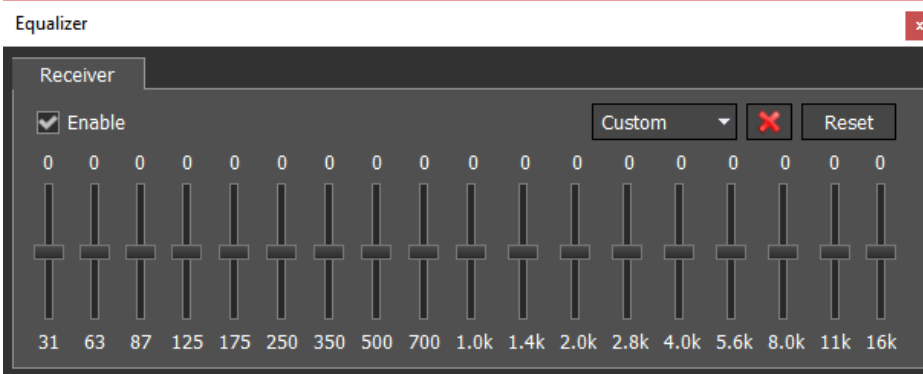

VAC - button enables the **VAC** (data exchange via Virtual Audio Cables).

SQL - button enables the squelch (**SQL**). Displayed as the vertical yellow needle on the S-meter. If the air signal - green needle, surpasses the SQL trigger threshold - yellow needle, then you'll hear the sound of the receiving station on the receiver's LF output. If the signal level is lower than the trigger threshold, you'll hear nothing.

Mute - button mutes LF signal (**Mute**).

VOX - (Voice Activated Transmit) button switches the transceiver in TX mode when you speak in the microphone, more details [here](#)⁹⁶ (**VOX**).

BreakIn - transceiver will automatically turn to the TX mode by the press on the CW keyer (**BreakIn**).

Drop-down menu with CW settings:

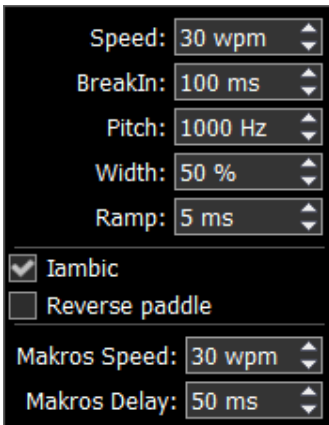

Speed - the speed of the CW signal being sent.

BreakIn delay (ms) - timing control, to keep the transceiver in the TX mode. Set the required time for the transceiver to hold in the TX mode after you let go of the CW keyer.

Pitch (Hz) - CW signal's frequency tone control. Set the required CW signal's frequency tone (also used for the RX mode).

Width (%) - Dot-to-pause ratio. Width value 50, means that Dot equals pause in length. Dash always equals 3 Dots.

Ramp (ms) - CW signals' slope length control. Set the required CW signals' slope length. The higher manipulation speed, the shorter should be slopes.

Iambic - enable/disable automatic dots and dashes generation. If the IAMBIC mode is off, while you press the CW keyer it will generate tone signal with PITCH frequency.

Reverse paddle - enable the checkbox to generate dots and dashes in reverse order.

Macros Speed - speed of CW macroses generation via TCI interface.

Macros Delay - CW macroses generation delay after switch from RX to TX, via TCI interface.

When you enable the BreakIn you'll see the following message in the Status bar:

WARNING! PTT switching delays are disabled in CW mode, and with CW manipulation in SSB! Be careful using an external PA!

PROC - enable the microphone signal processing menu (PROC). Profile adjustment in this menu is similar to the global profile menu:

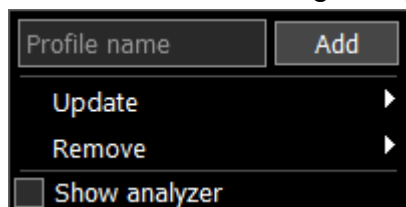

- **Add** a new profile, by entering the name of the profile in the “Profile name” field and pressing Add button.
- **Update** the settings of the certain profile from the list to the current settings.
- **Remove** the certain profile from the list.

Note:

- *All new profiles will be stacked up to the drop-down menu as a new line.*

- **Show analyzer** - enable it to activate **Transmitter signal analyzer** and analyze your own TX signal.

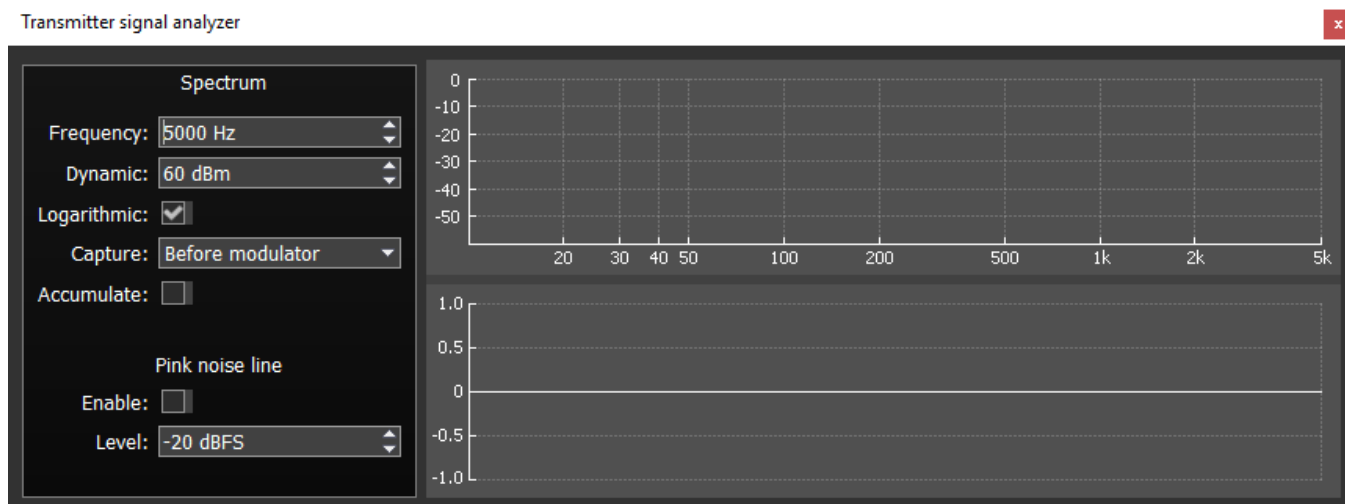

Frequency - top limit of the horizontal (frequency) scale of the transmitter.

Dynamic - vertical scale (dynamic range).

Logarithmic - allows you to change the ratio of the Frequency scale, making it either linear (by default) or logarithmic.

Capture (before modulator or after modulator) - select where you want to capture TX signal, before or after modulator.

This function is synced with the **Low latency** check-box in Options-> Device menu-> TX tab-> Monitoring in PC.

Accumulate - add a line showing peak values during the time of analysis.

Pink noise line (Enable) - enable the pink line showing the energy spread by frequency.

Level - pink noise line level.

It consists of the following functions:

Transmitter signal processing

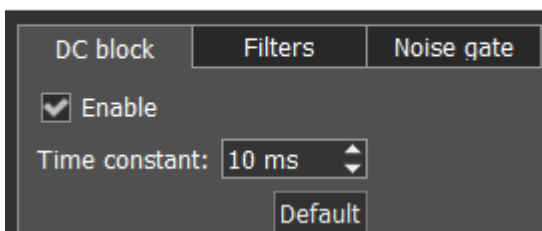

DC block's purpose is to effectively remove **Time constant** in the microphone signal. Changing of **Time constant** influence quality of the applied filter. You can test it by increasing or decreasing **Time constant** value in 1-10 ms range, you'll notice low frequencies reduction with 1 ms value and amplifying with 10 ms value.

Transmitter signal processing

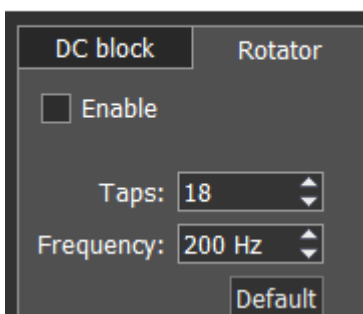

Phase Rotator.

Taps - amount of phase rotators (stages).

Frequency - frequencies below will change the phase.

The algorithm itself is fairly simple, firstly you should reach the max symmetric characteristic by adjusting the **Taps** parameter (in some applications it's called stages), after each change of the parameter check the result in the analyzer. Then change the **Frequency** parameter, with a 50 Hz step. Frequencies lower than the **Frequency** value are not rotated, everything above are

processed by the Rotator. All voices are unique and have their own AFC, that's why this module should be adjusted by the user himself.

Setting the right rotator settings is easy, you are trying to reach max symmetry with the **Taps** parameter (in some applications it is called stages), after each change of this parameter check the result on the analyzer.

After that change the Frequency parameter, with the 50 Hz step. Frequencies below the **Frequency** value are not influenced by the rotator, frequencies above the **Frequency** value are rotated.

All voices are unique, having their own AFC, that's why this module should be adjusted personally by the operator.

Why do you need a phase rotator? Sound vibrations created by human speech organs are asymmetric by amplitude. They have lots of negative and positive half-waves. It's natural and not a problem in itself, but some voices may be so asymmetric that compressor and limiter (which are controlled by peak or RMS signal level) may rapidly lower their levels because of such asymmetric signal peaks. As a result voice density may drift (vary in real-time), so the voice doesn't sound natural. Phase rotator changes phase ratios in a signal, leaving the AFC as it is (it's not an equalizer). Harmonics are shifted in relation to the main frequency, the signal becomes more symmetrical. Elimination of most asymmetric peaks in the signal lowers the "aggressiveness" level of the compressor influence, thus voice sounds more natural and dense at the same time.

Also, rotator gives you a psychoacoustic effect from amplifying the low frequencies and making your voice sound clearer. It appears because of harmonics time-shift in relation to fundamental frequencies. After the voice is processed with rotator, you hear harmonics and main frequencies at different times. It makes harmonics more prominent to our brain, creating a psychoacoustic effect making a voice clearer.

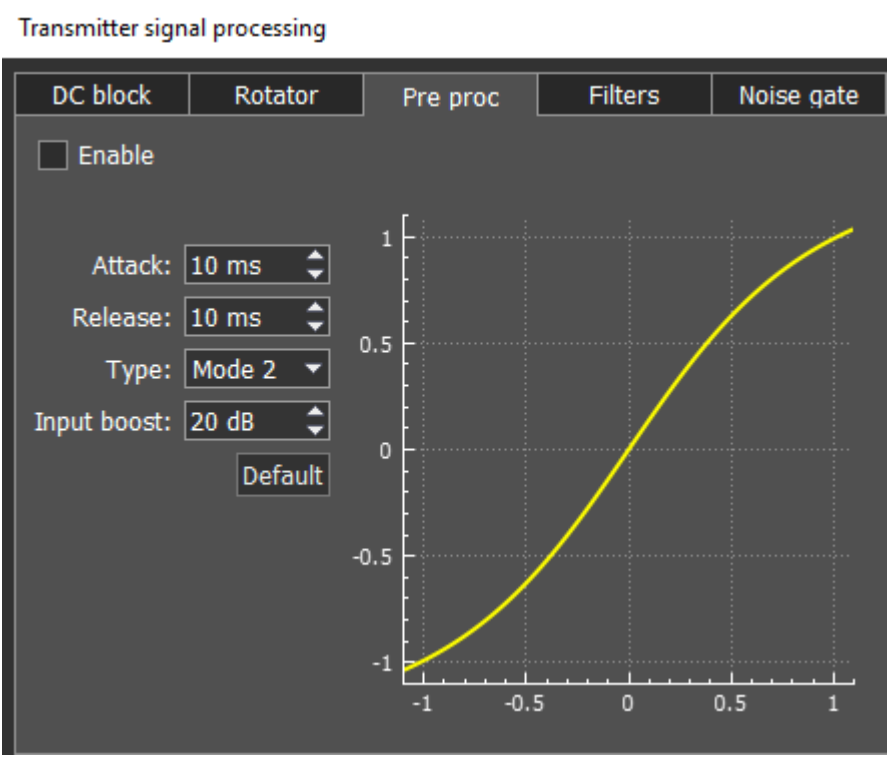

Pre-proc module enriches

signal with new harmonics imitating a tube preamplifier.

Attack - this is the period, when the limiter is decreasing volume to reach the level that is determined by **Max Amplitude**.

Release - this is the period, required for the signal level to be restored to the default value.

Type - there are 3 types of pre-proc algorithm, where the 1st is the most aggressive and the 3rd is the least aggressive.

Input Boost - preamplifying of the input signal before limiter processing.

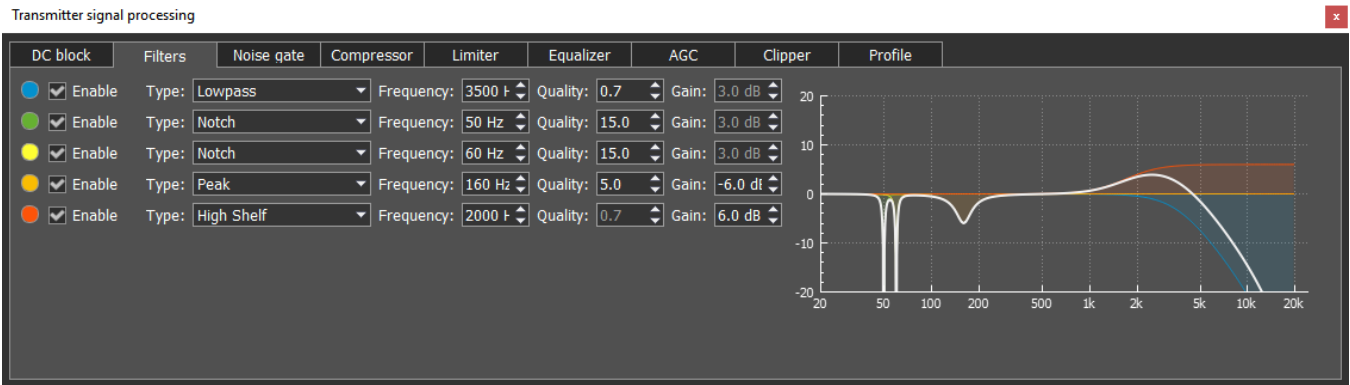

Parametric filter module with graphic display of the summed AFC (amplitude-frequency characteristic - white line) and AFC of each filter. Simultaneously you can use up to 5 filters. Available filter types:

Lowpass - Low Pass Filter (LPF). This filter passes signals with a frequency lower than a certain cutoff frequency. Cutoff frequency is determined by **Frequency**. **Quality** determines steepness of the filter slope.

Highpass - High Pass Filter (HPF). This filter passes signals with a frequency higher than a certain cutoff frequency. Cutoff frequency is determined by **Frequency**. **Quality** determines steepness of the filter slope.

Bandpass - this filter passes frequencies within a certain range (band) and rejects frequencies outside that range. Cutoff frequency is determined by **Frequency**. **Quality** determines bandwidth of the passband.

Notch - it is a band-stop filter with a narrow stopband. It rejects a specific range of frequencies and passes all the other frequencies unaltered. Tuning frequency is determined by **Frequency**. **Quality** determines the stopband bandwidth.

Peak - also known as bell filter. This filter has similar functionality with the Notch filter, but has more flexible settings. It boosts or cuts the chosen frequency by **Gain** value, affecting the surrounding frequencies in a bell-shaped curve. Tuning frequency is determined by **Frequency**. **Quality** determines the cutoff bandwidth.

Low Shelf - this filter cuts or boosts signals of frequencies below the cutoff frequency, determined by **Frequency**. **Gain** value determines attenuation or boost level of frequencies below the cutoff frequency. Frequencies above filter's AFC will not be altered.

High Shelf - this filter cuts or boosts signals of frequencies above the cutoff frequency, determined by **Frequency**. **Gain** value determines attenuation or boost level of frequencies above the cutoff frequency. Frequencies below filter's AFC will not be altered.

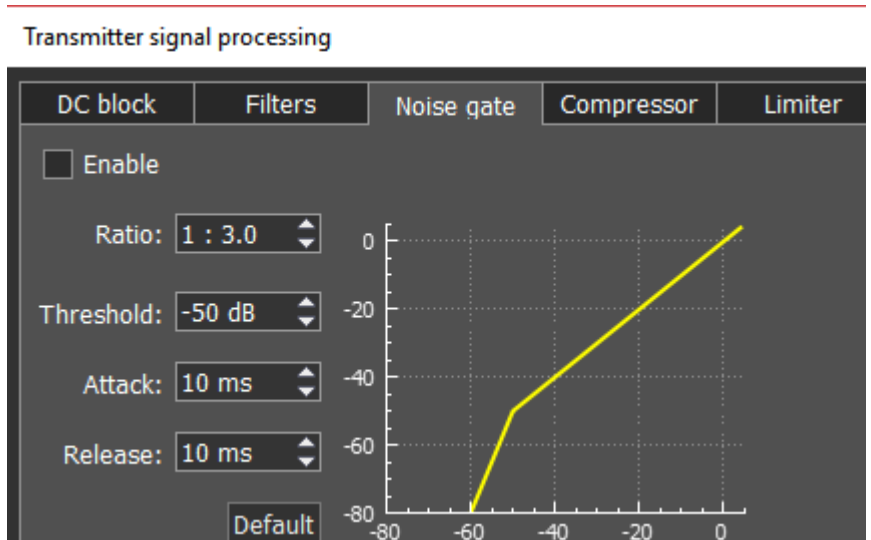

Noise gate or **gate**, removes signals below **Threshold** level. Usually it is used to reduce the noise in pauses.

Gate passes signal only when it's level is higher than set **Threshold**: gate is open. If the signal is lower than set **Threshold**, gate will not pass it (or significantly attenuate): gate is closed.

Gate should be used when the level of the desired signal is higher than the noise level. **Gate's**

level is set higher than the noise, so when there is no desired signal (higher than Threshold) gate is closed. **Gate** does not cleanse the signal from noises. When the gate is open, both signals get through, useful signal and noise.

Parameters:

Ratio - attenuation value, when **Gate** is closed. Usually this parameter is set for full rejection, i.e. signal does not pass through **Gate**, when it's closed. But sometimes you might require a mild rejection in this case adjust **Ratio**.

Threshold - it sets the level for **Gate** to open - pass the useful signal. It supposed to be set above the noise level, but below the useful signal level.

Attack - it sets time (ms), required for **Gate** to change state from closed to fully opened. If **Attack** time is short, as soon as the signal level goes higher than **Threshold**, it creates a sharp noise, longer **Attack** time creates a smooth transition from closed to opened state, but because of it, you may miss first sharp characters, like T, K.

Release - it sets time (ms), required for **Gate** to change state from opened to fully closed. If **Release** time is short, as soon as the signal level goes lower than **Threshold**, it creates a sharp noise, longer **Release** time creates a smooth transition from opened to closed state, it may sound like fading.

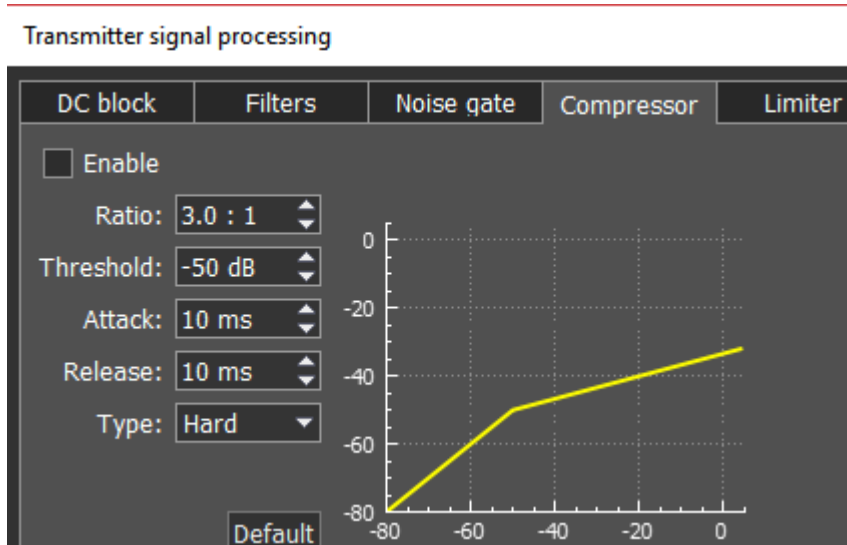

Compressor - is used to reduce dynamic range of the audio signal, in other words, compressor reduces the difference between the quietest and the loudest sounds.

Compressor automatically controls the volume. Downward compression reduces loud sounds over a certain **Threshold** while quiet sounds remain unaffected.

Compression may improve sound audibility in loud places, where background noises may suppress quiet sounds. While loud sounds will be easily audible, quiet sounds won't be audible, and if you'll increase overall volume, it will improve the situation for quiet sounds, but loud sounds will become unbearable. If you'll apply the downward compression to this audio, the overall

volume may be increased to the level when both quiet and loud sounds will be comfortable to listen.

Parameters:

Ratio - determines the ratio of input/output signals which exceed **Threshold**. For example, ratio of 3:1 means that if input level is 3 dB over the threshold, the output signal level is 1 dB over the threshold.

Threshold - a compressor reduces the level of an audio signal if its amplitude exceeds a certain threshold. It is set in decibels dB.

Compressor may be adjusted in a way how fast it reacts:

Attack - this is the period, when the compressor is decreasing volume to reach the level that is determined by **Ratio**. It is activated when the signal exceeds **Threshold** and, if each consecutive signal has higher volume than the signal before it.

Release - this is the period, when the compressor stops compression, increasing signal volume to the default level. It is activated right after **Attack** period is finished. Each time, when after the compressed signal goes the next one, which is lower than **Threshold** or higher, but lower than the compressed one before it, then instead of **Attack**, **Release** is applied for each consecutive signal like this one and compressor stops compression according to **Release** settings. Whether there will be a compression or not while **Release period**, depends on the set time. If in **Release period** signal is compressed, it is compressed with the same Ratio (dB) as the signal before it. Only in that case sounds lower than **Threshold** may be compressed.

Attack and Release parameters should be adjusted depending on how frequently signal volume is changing.

Type Soft/Hard knee - controls whether the bend in the response curve between below **Threshold** and above **Threshold** is abrupt (hard) or gradual (soft). A soft knee slowly increases the compression as the level increases and eventually reaches the compression **Ratio** set by the user. A soft knee reduces the audible change from uncompressed to compressed, especially for higher **Ratios** where a hard knee changeover would be more noticeable.

Knee - available only for soft knee, determines the knee smoothness.

Mic Gain and Compression settings:

1. Set the Meter to the Mic-meter mode in the Desktop style (right click on the S-Meter->TX->Mic-meter).
 2. Set the Drive level to 0.
 3. Enable the TX mode and speak in the microphone.
 4. Increase the Mic gain from 0 dB till the Mic meter readings will reach -10...-5 dB in peaks.
 5. If required enable the compressor.
 6. Set Compression to 2-5; set COMP threshold to ~ -30 dB. This level should be more than room noises for about 10-15 dB.
-

Transmitter signal processing

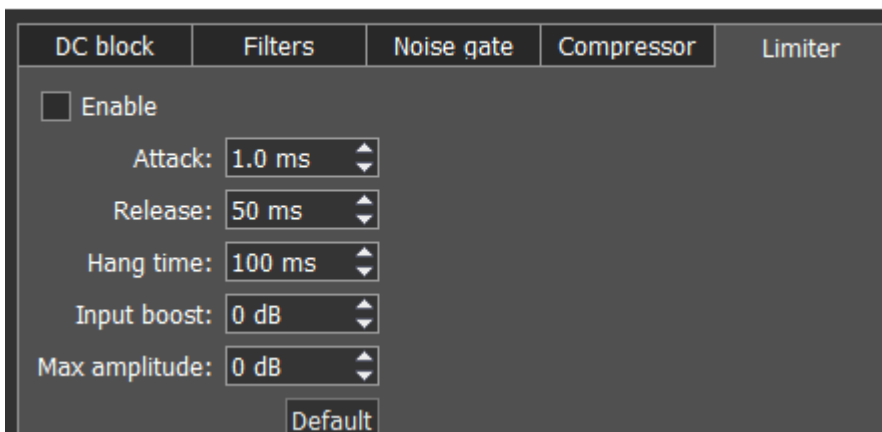

Limiter - is used to limit dynamic range, when signal exceeds **Maximum Amplitude** value. In most cases used to avoid overload (clipping) and suppression of short-term level peaks, while signal dynamic range is being leveled. As a rule, limiter is used along with increasing the input level on the **Input Boost** value, this technique increases overall signal level, while preventing distortion.

Parameters:

Attack - this is the period, when the limiter is decreasing volume to reach the level that is determined by **Max Amplitude**.

Release - this is the period, required for the signal level to be restored to the default value.

Hang time - sets time (in ms) to keep the signal level the same, after the **Attack** period is over and before the **Release** period is initiated.

Input Boost - preamplifying of the input signal before limiter processing.

Maximum Amplitude - sets the signals maximum amplitude on the limiter output.

Transmitter signal processing

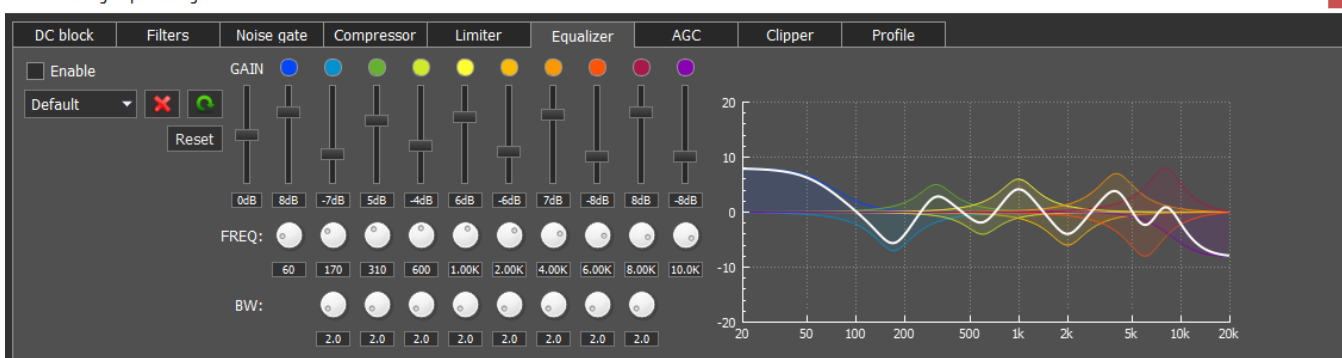

Parametric equalizer module with graphic display of the summed AFC (white line) and AFC of each equalizer. Each equalizer has independent set of controls: the center or primary frequency (**FREQ**), bandwidth (**BW**) and AFC level (boost or cut) - vertical slider. Press right mouse button on any control element to set it to the default value. Thus, using the parametric equalizer you can perform the finest tuning on any required frequency.

In this module, you can find 3 types of filters: **Low Shelf** (on the left), **High Shelf** (on the right), **Peaking** or **Bell** (8 units in between). Their operation is similar to the filters described in the **Filters** module.

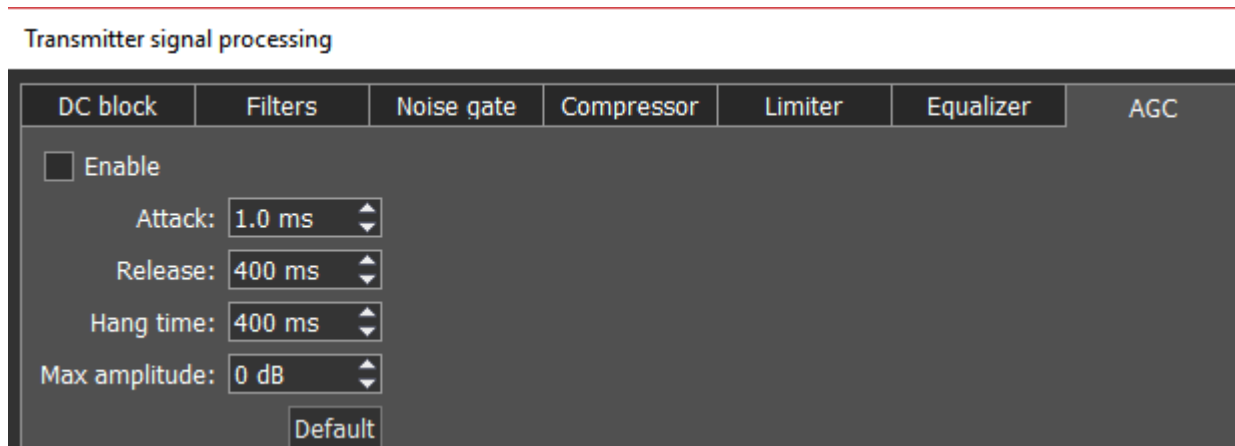

AGC

module is responsible for keeping the constant volume level of the Mic signal. Max **AGC** value might be adjusted by the Mic gain on the software front panel. If the Mic signal on the **AGC** input is too weak, then you might need to increase the Mic gain. **AGC** has a delay period which is adjusted by the **Attack**, increasing the **Attack** value will increase delay period.

Parameters:

Attack - signal attenuation period, this value determines how fast **AGC** will decrease the amplitude of the loud signal to the **Maximum Amplitude** value.

Release - signal recovery period, this value determines how fast **AGC** will increase the amplitude of the loud signal to the value which does not exceeds **Maximum Amplitude**.

Hang time - sets time (in ms) to keep the signal level the same, after **Attack** period is over, before beginning **Release** period.

Maximum Amplitude - sets the signals maximum amplitude on the **AGC** output.

Note:

- Set the MIC AGC gain, that the microphone signal is increased to the level of -10...-5 dB on the MIC-meter indicator (green bar).
- For correct AGC operation, we recommend setting identical **Hangtime** and **Decay** parameters. If you want to achieve leveled amplitude than **Hangtime** should be higher than **Decay**.

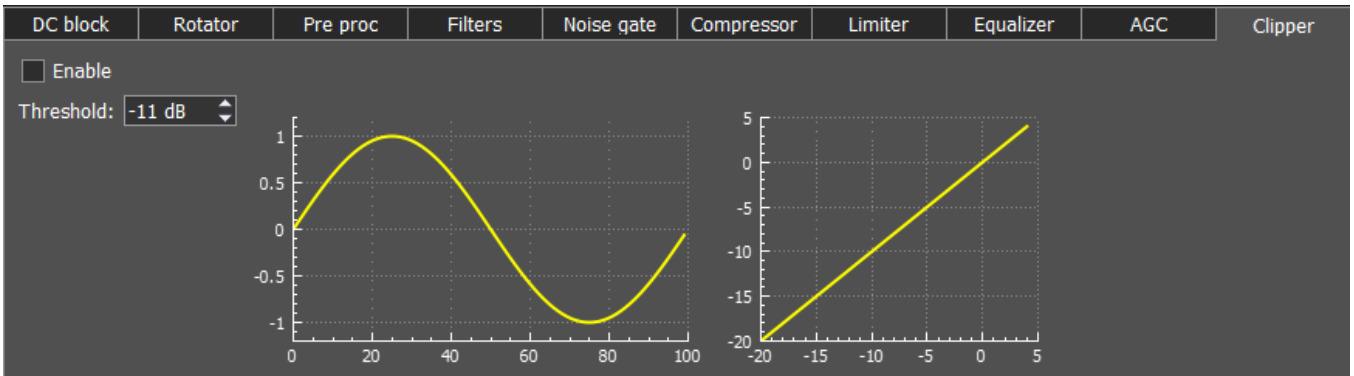

Clipping is a form of waveform distortion that occurs when the output Voltage exceeds **Threshold**. Visually (on oscilloscope) it looks like altered signal peaks, you can hear it as splutters and cracks. **Clipper** reduces signals peak-factor and increases overall power, but distorts the signal. **CESSB** filter default bandwidth is from 0 Hz low and 5 kHz high. Signal bandwidth can be adjusted by the user in the modulator settings.

Parameters:

Threshold - if the signal exceeds this level, **Clipper** alters it, sets in dB.

Transmitter signal processing

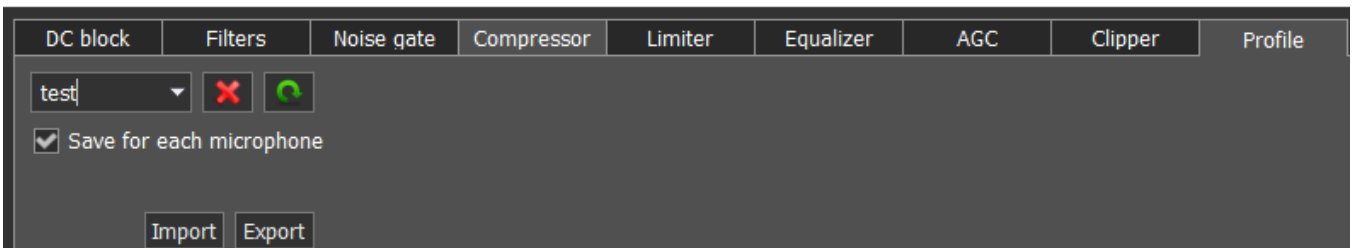

In the **Profile** tab, you can save settings of the whole TX processing module in a separate module, independent from the main software profile. Load PROC settings from a file by pressing the **Import** button and save a profile in a file by pressing the **Export** button.

To add a new profile, enter unique name in the input box and press the Enter button on your keyboard. You may also delete selected profile, by pressing the - **X**.

Save for each microphone - enable this checkbox to save all **PROC** settings separately for each microphone. E.g. you set your Mic1 settings, then switch to Mic2 and change some settings, then switch back to Mic1, as a result both Mic1 and Mic2 have their own different settings. If this checkbox is unchecked, all **PROC** settings apply for all microphones.

Note:

- Profile is a state of PROC settings which are not attached to any of Mic
- With checked **Save for each microphone** when you switch from Mic1 to Mic2, Profiles in PROC don't change. Even with checked **Save for each microphone**, you need to activate your previously set up Profile for a certain microphone. So the procedure should be, you set up 3 different Profiles A, B, and C. When you switch from Mic1 (with A) to Mic2 you should manually enable Profile B or C. With **Save for each microphone** checked each Mic saves

the latest settings it had in PROC menu, so when you change from Mic1 to Mic2 it loads the latest settings Mic2 had.

EiBi - show the HF stations markers on the panorama from the EiBi database (**EiBi**). Hover with the mouse pointer on the station frequency and you'll see its name.



IQ - IQ-files recording is required for storing the RX bandwidth panorama (**IQ**). The file is saved to the C:\Users\User_Name\ExpertSDR2\MB1\wave\.

SKM - turn on the CW Skimmer, more details in [CW Skimmer](#)^{D127} (**SKM**).

SM - bigger S-meter button (**SM**).

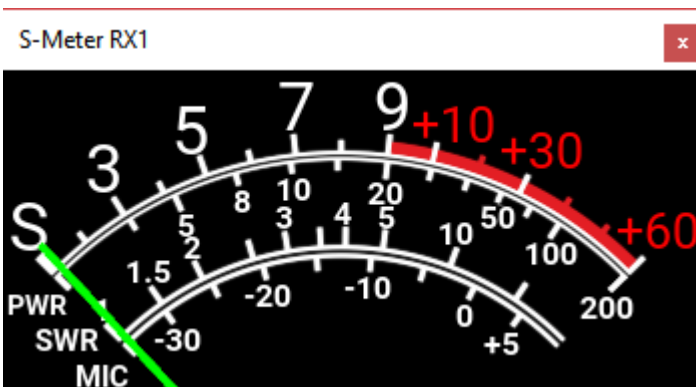

- the S-meter window can be separated from the software window and moved to any place on the screen.

List of the measured parameters:

S-meter - Displays the level of the received signals in the receiver filter bandwidth (in units).

PWR - Displays the level of the output power in TX mode (in Watts).

SWR - Displays the SWR level in TX mode (**blue** bar).

MIC - Displays the level of the MIC signal before modulator (in dBW, **green** bar).

SQL - Squelch trigger threshold for the received signals (**yellow** needle).

 - press this button to clear the panorama of all displayed spots.

When you enable the **NFM** mode, three additional buttons appear:

 - **Burst Tone** button (**BT**). In some cases, repeater stops working after some time - goes to "sleep" mode. To wake it from the "sleep" mode you need to send the Burst Tone of the exact frequency for some time (a common value for tone frequency is 1750 Hz, but can vary in some repeaters). For more info on how to use the BT tones see [Burst Tone using](#)^{D190}.

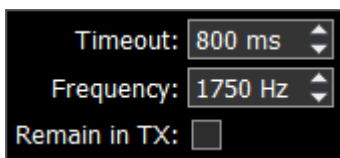



- You may adjust signal **Timeout** and **Frequency** in the drop-down menu.

Remain in TX checkbox - set to stay in the TX mode after the timeout.

 - **Continuous Tone-Coded Squelch System** button. In some cases, it's required to activate the squelch with the help of the **CTCSS** tones.

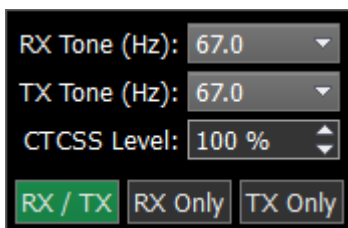
You set the **CTCSS** level relatively to your voice signal. For more info on how to use the CTCSS tones see [CTCSS Tones using](#)^{D190}.



 - button switches the shift of the transmission frequency, to operate through a repeater. This function is usually used on the 10M, 6M, 2M and 70cm bands.

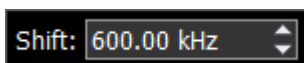



- in the drop-down window, you can adjust the **Shift** frequency.

Enable the shift of the TX frequency to work through a repeater. The sub-receiver displays the TX frequency and the main receiver displays the RX frequency.

When you enable the **WFM** mode, one additional button appears:

 - when enabled, this function allows the software to automatically detect whether the station is strong or not and lets you listen to it in **stereo** mode.

 - **Play/Record** buttons. Press the **Record** button to record the RX audio signal. Press the **Play** button with the right mouse button to play the record instantly via the IQ player. Press the **Play** button with the left mouse button to transmit the recorded audio on the air.

 - **AGC** sensitivity control slider (Automatic Gain Control on classic transceiver). The adjusted level is saved per band.

Drive:  - slider for the transceiver's output power adjustment.

Tune:  - slider for the transceiver's output power adjustment while transmitting the tone (carrier) signal.

Mic 1  - slider for the microphone gain level. In CW mode, it switches to the **Speed** button and duplicates the **BreakIn** functionality.

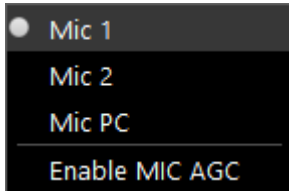

- In the drop-down menu, you can select **Mic1**, **Mic2** - transceiver's microphones, **Mic PC** - PC's microphone. For fine tuning of the PC microphone open: **Options** > **Mic** tab (more details in the [Mic tab](#)⁹⁵). Also in this menu, you can **Enable Mic AGC**.

Note:

•Remember, if you disable the MIC AGC, it may distort your signal and cause interference to neighboring stations.

A panel of mode buttons:



AM - Amplitude Modulation

SAM - Synchronous Amplitude Modulation

DSB - Double Side Band

LSB - Lower Side Band

USB - Upper Side Band

CW - CW mode. It works in CW-U for all bands. It cannot be changed.

NFM - Narrow FM

WFM - Wide FM, supports receiving of the stereo signals

SPEC - Spectrum mode. Receive the pure signal without any demodulation (panadapter bandwidth). The idea is to receive pure signal then pass it to some special device, via a cable connected to the PHONES audio output of the transceiver or PC audio output, with certain demodulation capabilities

DIGL - Digital Lower Side Band. Connect a third-party software (is not supplied) to the transceiver software for operating in digital modes

DIGU - Digital Upper Side Band. Connect a third-party software (is not supplied) to the transceiver software for operating in digital modes

Note:

•To work in digital modes, use DIGL and DIGU. Mic AGC gain, COMP and EQ can distort the TX digital signal, that's why they are automatically disabled in these modes. Also in DIGL and DIGU modes, you can save your TX and RX filter width.

DRM - Digital Radio Mondiale, 10 kHz filter with 5 kHz IF to work with the external decoder of the DRM signals. Connect third-party software (is not supplied) to the transceiver software for decoding of the DRM signals



160M - 2M - amateur bands

GEN - if out of the amateur bands

5.3.2.2 Frequency and S-meter indicators

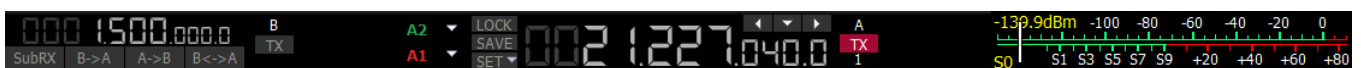

Mainly, this panel consists of the visual indicators, like the VFO A/B frequencies, the signal level on the antenna's input (S-meter) and several control buttons.

Displaying elements:



Note:

•You won't hear the audio from the VFO B if it is out of the panorama bandwidth.

Sub-receiver control unit:

SubRX **B->A** **A->B** **B<->A** - **SubRX** - enable sub-receiver. If you want to listen to the VFO A and VFO B frequencies simultaneously, use the Sub-receiver.

1. Activate the Sub-receiver by pressing the **SubRX** button.
2. Set the required VFO B frequency.
3. Listen to the VFO A and VFO B frequencies simultaneously.

Note:

•VFO A receiver's red tuning line means that in Sub-RX mode you'll transmit on the VFO A frequency.

To turn the Sub-receiver to transmit, press the **red TX button/indicator**.

You can switch the point and click control on the panorama between VFO A and VFO B receivers, by pressing the middle mouse button. You'll control the RX with the same color to the mouse cursor.

When you change the band the **SubRX** is disabled.

B>A - assign the VFO B frequency to VFO A

A>B - assign the VFO A frequency to VFO B

B<>A - swap frequencies between the VFO A and VFO B

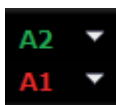

- Antenna switch indicator. It displays which antenna input is used for RX and TX.



- VFO A frequency indicator (main receiver).

Main receiver control unit:



LOCK - lock the VFO A frequency tuning.

SAVE - save the current VFO A frequency and mode type in the memory panel.

SET - manual frequency input for VFO A or VFO B.

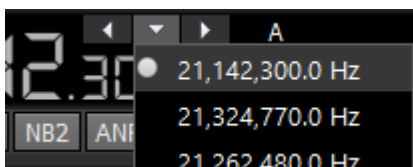

- **Navigation buttons**. The quick memory cells are automatically stored with the frequencies if the receiver stands still over a second. Then those frequencies can be selected in order back and forth, as in an internet browser. The total stack contains 16 cells.



- **Band Stacking Memories** indicator (VFO A only). Each memory slot has a frequency, mode, and filter settings. Each band has three memory slots associated with it. Successive presses of a band button will cycle through the stored memory slots. It might be useful for quick frequency and mode changes within a band. To replace one memory slot:

1. click the required band button you would like to modify.
2. change the frequency (within a selected band), mode, and filter to the required settings.
3. click the band button again to save the values.

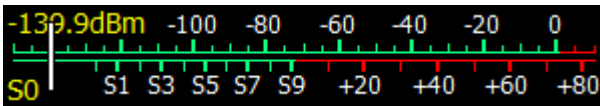

- **S-meter** - by default this scale displays the power level of the signals in the RX filter bandwidth. The scale has two grade types: in S-units and in dBm. The signal strength displayed in dBm to mW (yellow figure) in the top left corner of the S-Meter. In the TX mode, the output power is indicated in W and antenna's SWR.

Note:

• *S-Meter in the ExpertSDR2 has two different calibrations for HF (0-30 MHz) and VHF (30-300 MHz). HF and VHF signals with the same dBm level have different S-scale values. For example: HF S9 = -73 dBm = 50 uV (50 Ohm), VHF S9 = -93 dBm = 5 uV (50 Ohm). S-Meter in the ExpertSDR2 corresponds to the IARU recommendations, each device is calibrated at the manufacturing.*

Click the right mouse button on the S-meter and select the display type for RX or TX:

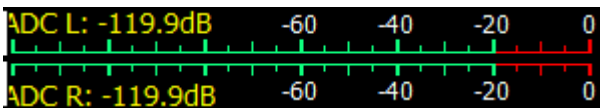

- ADC type displays the power in each quadrature channel (double scale) in RX mode.



- In the TX mode, the MIC-meter type shows the microphone's signal level. In the Power/SWR-meter type, the power indicator and SWR will be displayed.

5.3.2.3 DSP control panel

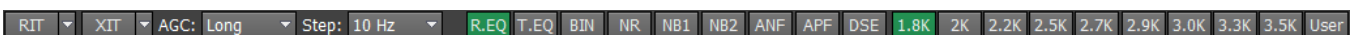

RIT - Receive Incremental Tuning.

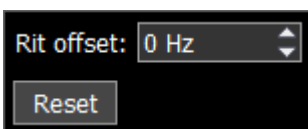

- In the drop-down menu, you can set the frequency offset in Hz. **Reset** - resets the offset value to zero (more details in [RIT¹⁹³](#)).

XIT - Transmit Incremental Tuning (more details in [XIT¹⁹⁵](#)).

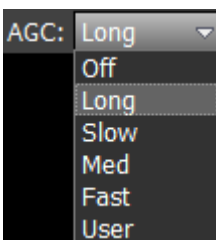

- **AGC** presets menu. In the drop-down menu, you can select the receiver's AGC preset:

OFF - AGC is off.

LONG - preset with long AGC reaction (approximately 750 ms). Recommended for phone modes.

SLOW - preset with slow AGC reaction (approximately 500 ms). Recommended for phone, digital modes.

MED - preset with medium AGC reaction (approximately 250 ms). Recommended for CW, digital modes.

FAST - preset with fast AGC reaction (approximately 100 ms). Recommended for CW, digital modes.

USER - preset with custom AGC reaction (by default the slowest 1000 ms).

Note:

•AGC settings influence the quality of the received signal. Be careful selecting the AGC preset or tuning your own preset.

Step: 10 Hz ▾ - **Step** list allows to change the step of the **mouse wheel** in the range from 0.1 Hz to 100 kHz.

DSP functions:

R.EQ - enable the RX equalizer (enabled on the picture).

T.EQ - enable the TX equalizer.

BIN - binaural audio mode (the phasing of the audio signal within the RX filter gives a stereo-like effect).

NR - enable the adaptive Noise Reduction to clean the signal from noise interferences.

NB1 - enable the First Noise Blanker for impulse interference.

NB2 - enable the Second Noise Blanker for impulse interference.

Note:

•The NB1 and NB2 algorithms are different. Try each of them to reach the best impulse interference reduction. NB1 and NB2 Noise Blankers can be used simultaneously.

ANF - enable Automatic Notch Filter for adaptive rejection of the narrowband interference in the receiving band (interference, carrier signals, CW signals, etc.).

Note:

•If there are no interference, ANF could slightly affect the reception quality of the desired signal. Disable ANF, if you don't need it.

APF - enable Analog Pick Filter, it creates the triangle filter's AFC (amplitude-frequency characteristic) in the filter bandpass.

Note:

• When filter BW is lower than 200 Hz, there is no point in APF, thus it is switched off automatically.

DSE - enable Digital Surround Effect for CW signals, it provides a space orientation in stereo phones.

Note:

• This algorithm provides panorama acoustic of the CW signals in the filter bandwidth, depending on their position in the filter:

if the received CW signal is in the receive filter bandwidth and lower the tuned frequency, it will be louder in the left phone;

if the received CW signal is in the receive filter bandwidth and higher the tuned frequency, it will be louder in the right phone;

if the received CW signal is in the receive filter bandwidth and in the middle of the tuned frequency, it will be equally loud in both ears.

RX filter bandwidth presets. Presets list depends on the mode type:

3K 3.5K 4K 5K 6K 8K 10K 12K 16K User - AM, SAM, DSB, NFM modes (3 - 16 kHz);

1.8K 2K 2.2K 2.5K 2.7K 2.9K 3.0K 3.3K 3.5K User - LSB, USB, DIGL, DIGU modes (1.8 - 3.5 kHz);

50 100 250 400 500 650 800 1000 1200 User - CW mode (50 - 1200 Hz);

50K 80K 110K 120K 150K 180K 240K 280K 310K User - WFM mode (50 - 310 kHz);

10K - DRM mode (has one fixed bandwidth 10 kHz);

User - user can adjust the RX filter bandwidth by himself (available at any modulation type except DRM).

5.3.2.4 Panorama description

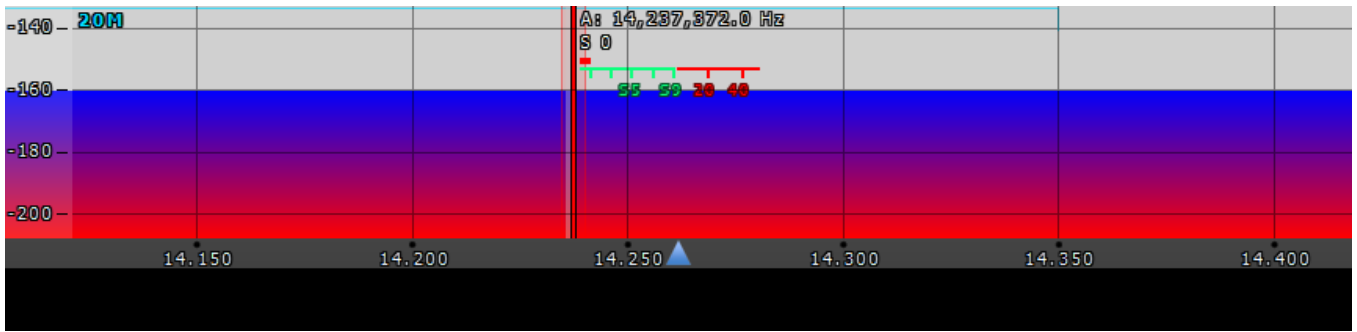

The panorama consists of two parts: 1) Spectrum Scope and 2) Waterfall.

5.3.2.4.1 Spectrum Scope

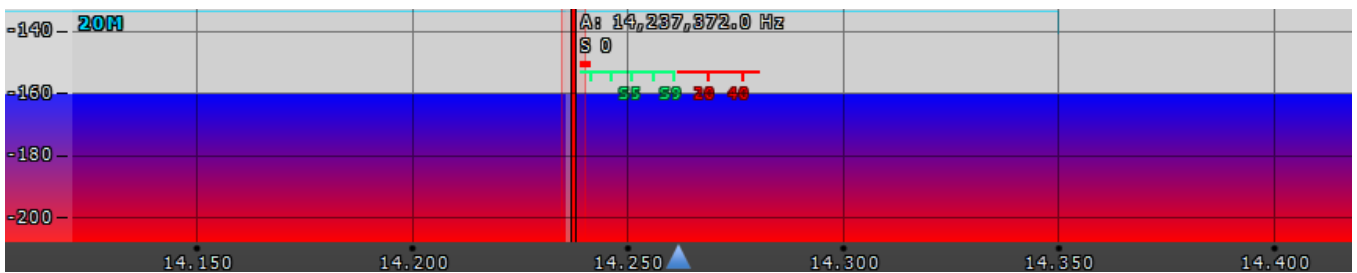

In this window, you can see the spectrum, with the sample rate from 39 up to 312 kHz (adjustable by User) and the RX filter to tune and listen to the stations.

There is a vertical scale on the left side of the spectrum scope, it indicates the power level of signals in dBm. Amateur band indicator displayed as the blue line on top of the graph with the name of the band, it shows the limits of the amateur band.

RX/TX filter position is indicated by the vertical red line. To the right of the line indicated it's precise tuning frequency (can be switched off in Options). Below the frequency, you can see the signal level on the S-Meter scale (can be switched off in Options). RX filter bandwidth displayed as the translucent gray area around the tuning frequency. You can listen to everything within this band.

Spectrum is displayed as a line on the spectrum scope, but it also may have a filling color. You can change spectrum rendering mode, line color, filling color, transparency, etc. in the software Options (more details in the [Spectrum tab](#)^{D¹¹⁰}).

5.3.2.4.1.1 Spectrum Scope scaling

If you move the mouse cursor over the vertical scale a hand will appear. Press and hold the right mouse button, then move it up/down to change the dBm scaling or press and hold the left mouse button, then move it up/down to change the spectrum level.

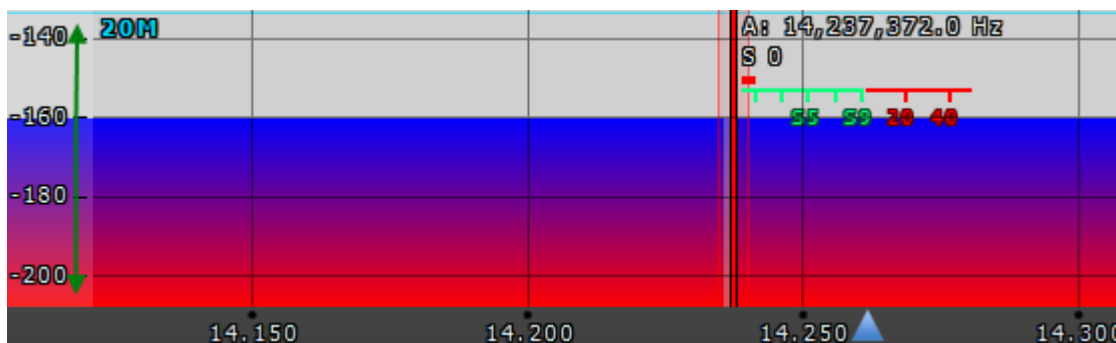

The horizontal scale between the spectrum scope and waterfall shows the frequency of the certain point on the spectrum. If you move the mouse cursor over the horizontal scale a hand will appear. Press and hold the right mouse button, then move it left/right to zoom in/out the panorama or press and hold the left mouse button, then move it up/down to change the ratio of the spectrum to waterfall.

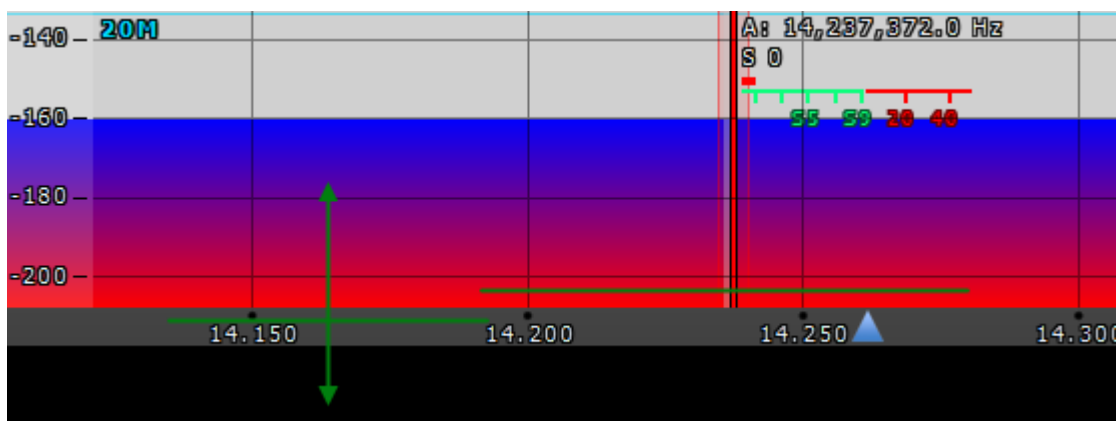

Zoom in/out of the panorama is carried out relative to the **Zoom position** marker.

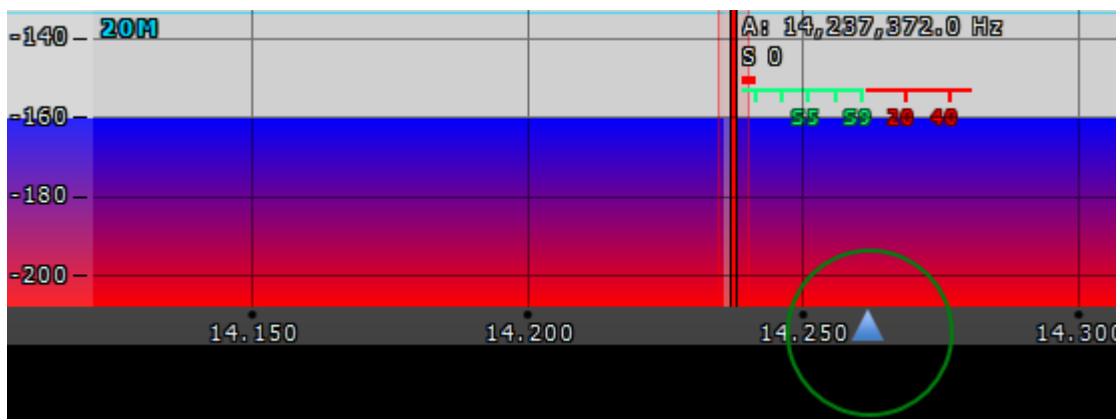

There are two ways to change the **Zoom position**:

1. Press and hold the left mouse button on the **Zoom marker** and drag it left/right,
2. Click the mouse wheel on the frequency scale.

5.3.2.4.2 Waterfall

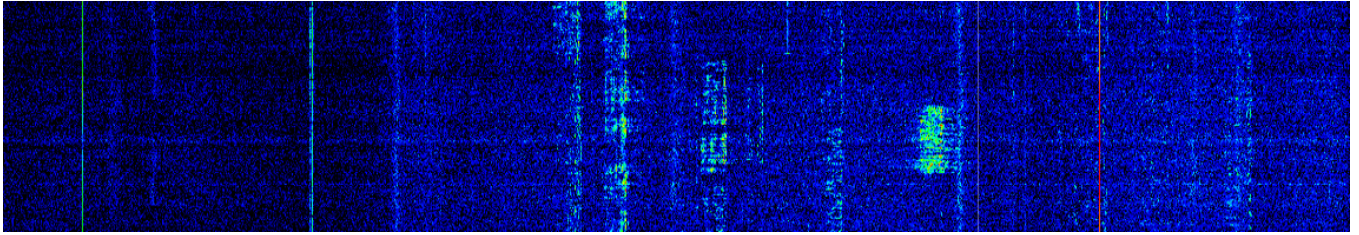

Waterfall graphic - timed spectrum scope in the format: amplitude - brightness, frequency - horizontal, time - vertical. The comfortable settings are set by default, but you can change them if necessary (more details in [Waterfall tab](#)¹¹³).

5.3.3 Status bar

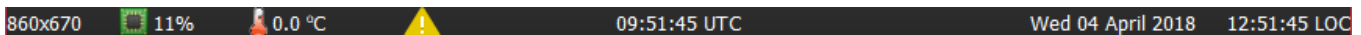

The status bar displays the following information (from left to right):

- ExpertSDR2 window size in pixels.
- CPU load in percent.
- The temperature inside the transceiver.
- **Yellow** warning triangle, in case you've enabled the **BreakIn** with CW or SSB mode.
- Coordinated Universal Time (UTC).
- Current date and Local Time.

5.4 Options

For fine tuning of the ExpertSDR2 software open the **Options** menu, by pressing the  in the software main window or **Options** button (in the **Desktop** style) in the top right corner of the software window.

Note:

✦ If you changed anything in the menu and you don't like it, but you forgot the default value, you can reset all setting to default values by simply clicking the **Global Default** button.

✦ You can check the changes without leaving the **Options** window, just click the **Apply** button.

✦ If you are satisfied with the changes and don't want to change anything else, click the **OK** button to close the **Options** window.

Warning!

① We recommend you study this section of the manual very carefully because many settings are hidden in the sub-menus.

5.4.1 Device menu

In the **Device** menu, you can find software functions of the signal processing and hardware settings.

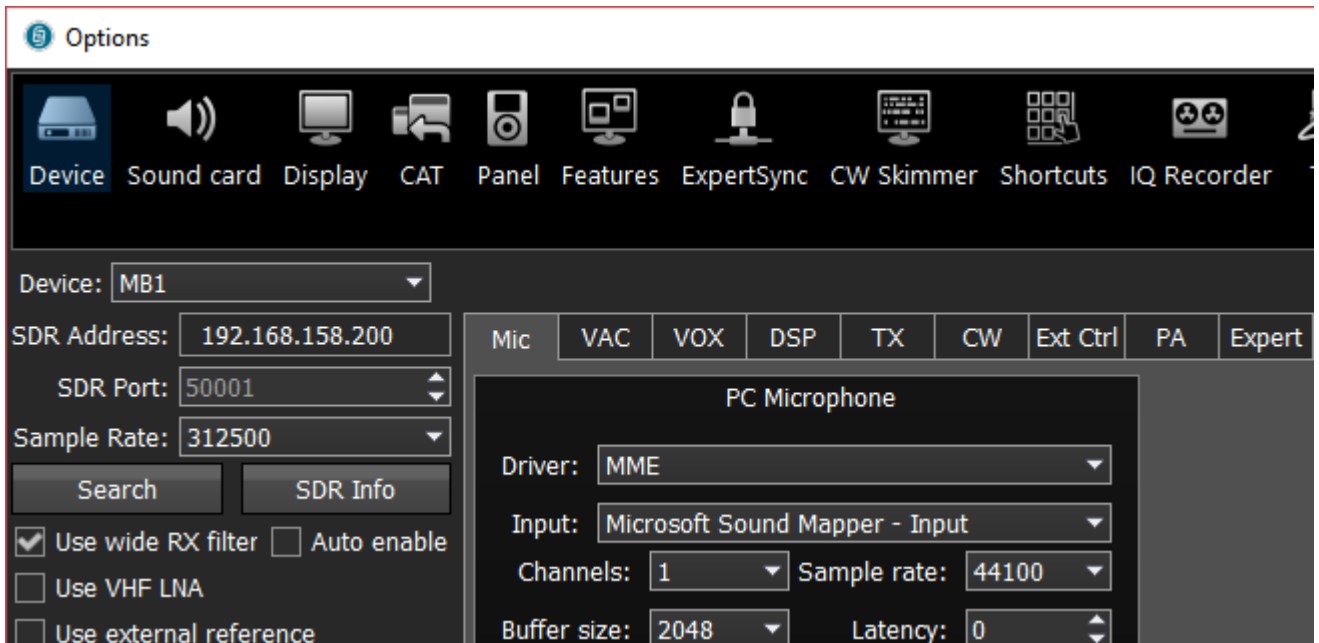

The left part of the **Device** menu is for the main system functions of communications between the transceiver's software and hardware.

Device - device type menu. Shows that the ExpertSDR2 software works in the MB1 mode.

SDR Address - physical static IP-address of the SDR module, locked at 192.168.158.200.

SDR Port - port number, which is used for the data exchange, locked at 50001.

Sample Rate - IF sample rate, equals the panorama bandwidth. You can select one of four panorama bandwidth values.

Search - search the device in the local network. When you press the **Search** button, software searches for the SDR-device in the network.

SDR Info - button to show you the transceiver serial number, firmware revision, PCB revision and set options.

Note:

•You can use this button to test the connection between the software and SDR module. If the connection is successfully set up - you'll see the transceiver's info, if not - nothing will show up.

Use RX Wide filter - set the Use RX Wide filter checkbox to enable the wide filter for the whole HF (0...65 MHz) or VHF (95...155 MHz) band.

Auto enable - set the Auto enable checkbox to auto enable RX WF when the band-scope and/or the second receiver on the other band are switched on.

VHF LNA - set the VHF LNA checkbox to auto enable Low Noise Amplifier for the VHF band.

Use external reference - set this checkbox to enable **REF input** on the rear panel of the transceiver and synchronize it with the 10 MHz reference oscillator.

5.4.1.1 Mic

There are two microphone settings categories in the **Mic** tab: **PC Microphone**, **AGC**.

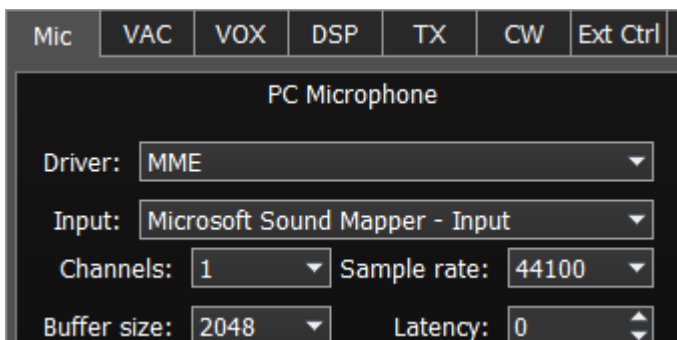

In the PC Microphone category, you can adjust the internal PC's sound card, which is connected to the microphone.

PC Microphone category consists of the following items:

Driver - select the sound card's driver type.

Input - select the sound card's physical input.

Channels - select the amount of the sound card's used channels.

Sample rate - sampling frequency.

Buffer size - size of the buffer.

Latency - signal delay time.

5.4.1.2 VAC

If the ExpertSDR2 and digital modes software run on the same computer, they can be connected via a virtual audio cable without wires and sound cards.

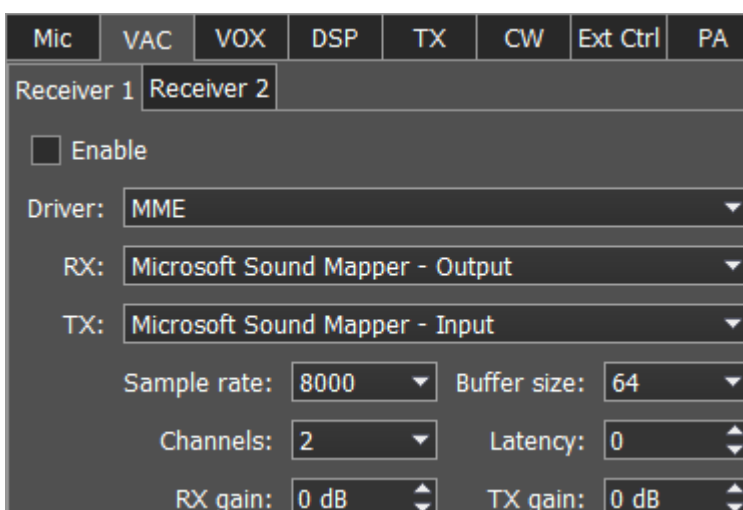

For each program receiver (RX1, RX2) you can set the virtual audio cable on the corresponding tab **Receiver 1** and **Receiver 2**.

Enable - set the Enable checkbox to enable virtual audio cable.

Driver - select the audio cable's or sound card driver type.

Input - select the sound card's physical input or the virtual audio cable's number.

Sample rate - sampling frequency.

Buffer size - size of the buffer.

Channels - select the amount of the sound card's or virtual audio cable used channels.

Latency - signal delay time.

RX gain - additional signal amplifying in the virtual audio cable's RX path in dB.

TX gain - additional signal amplifying in the virtual audio cable's TX path in dB.

Note:

• *Before enabling the VAC, make sure all settings for audio devices are correct.*

• *If the digital modes software works on the external PC, then in VAC settings you should set the internal MB1 sound card.*

• *To transmit the signal from VAC, PTT command should come from CAT interface, **not** by pressing the MOX button or PTT foot-switch. Thus third-party software controls when transceiver goes to TX or RX via CAT interface.*

5.4.1.3 VOX

On the **VOX** tab, you can see the settings of the Voice-Operated Transmit system.



VOX system triggers when the microphones voice signal exceeds the **Threshold**. The **Threshold** could be set for each microphone individually.

Set the **VOX enable** checkbox to enable VOX system.

Timeout to RX - VOX release time.

Threshold - VOX engagement threshold.

5.4.1.4 DSP

On the **DSP** tab you can see the AGC's and Digital Signals Processing settings.

There are two types of settings in the drop-down menu:

AGC - receiver's AGC settings.

DSP - digital processing filter's settings.

Receiver's AGC settings

There you can find fine AGC settings. AGC settings are divided by the processing speed on **Long, Slow, Med, Fast** and **User**.

Each settings type has its own tab and differs from others in terms of Attack, Decay and Hang time.

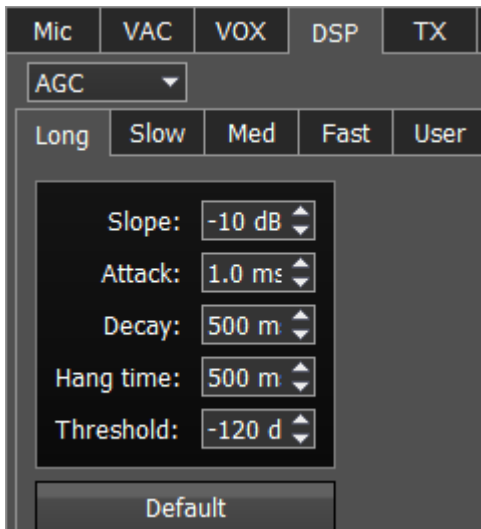

AGC parameters:

Slope - set the slope of the transfer characteristic.

Attack - when a signal gets stronger, this value determines how quickly the AGC will decrease gain.

Decay - when a signal gets weaker, this value determines how quickly the AGC will increase gain.

Hang time - signal recovery time.

Threshold - AGC trigger threshold.

Default - reset AGC setting to the default level. Press the Default button if you set wrong AGC values and don't like the result. Each AGC tab has a Default button.

Digital processing filter's settings.

There you can find fine the settings of the receiver's digital processing filters. DSP functions clear the signal from abnormal noises and crosstalk. These are the standard functions:



NR - Noise Reduction, removes the white noise. This is a special adaptive filter, which removes any abnormal noises from the air in the RX filter band.

ANF - Auto Notch filter, removes the carrier signals. This is a special adaptive filter, which removes any periodical signals from the air in the RX filter band.

NR and **ANF** parameters:

Taps - filter taps, determines the quality of the filter functionality.

Delay - trigger delay time.

Rate - set the adaptation rate of the filter.

Leak - set the signal's level.

APF - Analog peak filter for CW and SSB mode. Provides a more comfortable listening of the CW signals by amplifying the CW signal in the center of the receive filter (triangle filter's AFC (amplitude-frequency characteristic) in the filter bandpass).

CW APF - Analog Peak-Filter for CW mode.

SSB APF - Analog Peak-Filter for SSB mode.

Gain - Analog peak-filter amplifying factor.

Quality - Analog peak-filter quality (slope sharpness).

Frequency - central frequency of the voice signal.

Filter taps - receiver's filter taps for SSB, AM/NFM, DIGL/DIGU, CW modes, by default 1537.

The higher the receiver's filter taps value, the more rectangular the filter's shape, but it also increases the signal pass delay. That is why the user should find the best settings for himself,

between acceptable filter slopes steepness and signal delay. Optimal filter taps are set by default.

Noise blanker - removes impulse interference. Noise blanker parameters:

Threshold NB 1, 2 - filter trigger threshold. Set the required filter 1, 2 trigger thresholds, depends on the interference level.

Note:

◆NB has a threshold, set it to cut pulse noise if it surpasses the threshold. As a rule, pulse noise is a high-amplitude and short in time signal, with an amplitude much higher than useful signal. If it will be cut from the mix of signals the useful signal won't be corrupted. For correct operation, the threshold level should be adjusted higher than useful signals. In this case, NB will work perfectly. If the threshold will have the same level as useful signals or lower, the NB will try to cut useful signals and you'll hear and see distorted signals in phones and spectrum scope. If noises have white spectrum (not pulse) with low level (lower than useful signals), the NB cannot be used in this case, use NR.

DSE - Digital Surround Effect for CW signals. Provides a space orientation in stereo phones, stations from lower frequencies are louder in the left channel, stations from higher frequencies are louder in the right channel. The signal in the filter's center is equally heard in both channels of stereo phones.

Quality - DSE filter quality. The higher the quality value the stronger the function's effect.

Swap channels - swap right and left receiver's channels. Set the Swap channels checkbox for correct DSE functionality, if required. Correct functionality - slowly increasing the receiver tuning frequency, while receiving the CW signal, sounds as if CW signal moves from the right to the left channel.

Note:

◆DSE effect cannot be heard in mono phones.

WFM - Wide FM standard:

USA - set this checkbox to listen to WFM stations in the USA or South Korea.

Default - press to return settings to the default state. Each settings category has the Default button. Press the Default button if you set wrong values and don't like the result.

5.4.1.5 TX

In this tab, you can adjust the TX filter separately for different modes.

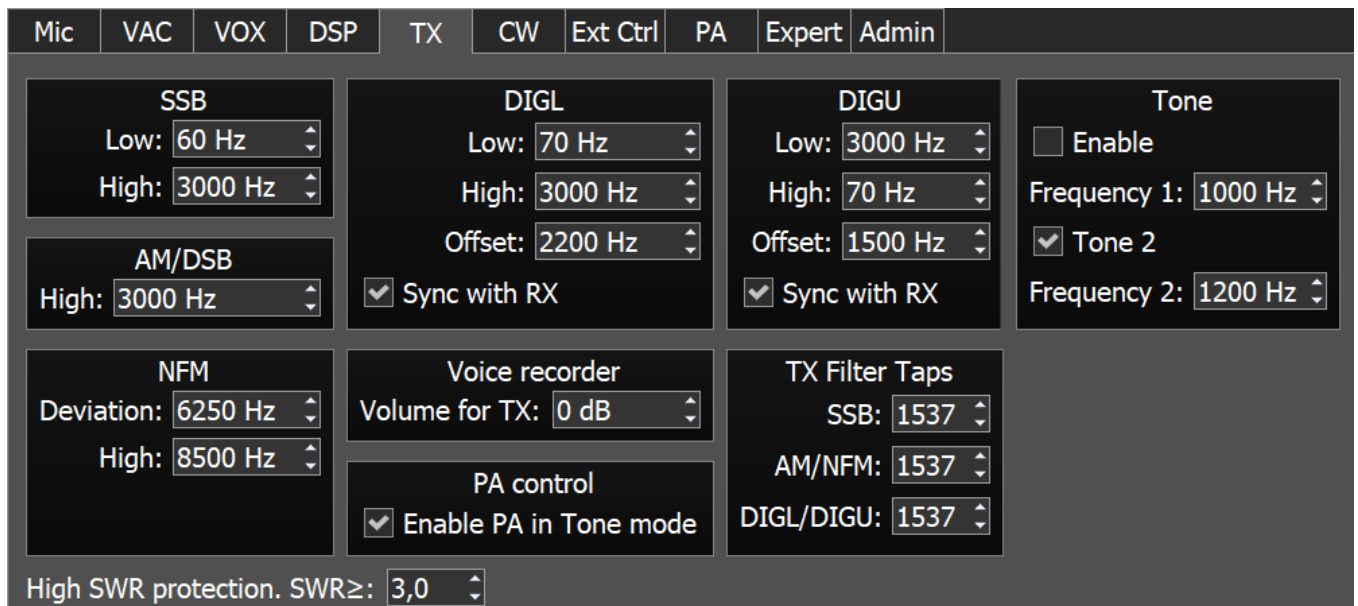

SSB/DIGL/DIGU/AM/DSB - settings for the low or/and high TX filter fronts.

Low - low front filter's frequency.

High - high front filter's frequency.

Offset - frequency offset. Used for work in digital modes. Frequency offset requirement depends on the used digital mode program. Look at the instruction of your digital mode program.

Sync with RX - set this checkbox to make TX filter bandwidth equal to RX filter bandwidth.

Note:

• *Limits of the TX filter bandwidth in SSB mode: low - from 10 Hz up to 10000 Hz, high - from 60 Hz up to 18000 Hz.*

Tone - settings for the dual-tone signal.

Enable - enable the dual-tone transmission mode.

Frequency 1/2 - set the independent frequency for the Tone 1 and Tone 2 signals respectively.

Tone 2 - enable the Tone 2 signal.

NFM - Narrow band receiver FM settings.

Deviation - FM deviation. The width of the FM signal on air will be twice the deviation width.

High - frequency of the high filter slope of the LF signal before FM demodulator. Set the required LF signal width from zero up to high filter edge.

Voice Recorder - settings of the playback level.

Volume for TX - additional gain volume in TX for the voice record. Set this parameter so that the signal on MIC-meter would reach -10...-5 dBW values.

PA control - external PA control settings.

Enable PA in Tone mode - checkbox to enable the TX mode of the external PA in the Tone mode (transmission of the carrier frequency). Set the Enable PA in Tone mode checkbox to enable the TX mode for the external PA while transmitting the carrier frequency. This mode might be useful to tune the building out a network of the external PA.

TX Filter Taps - transmit Filter Taps settings.

SSB - Filter Taps in SSB mode.

AM/NFM - Filter Taps in AM mode and narrowband FM.

DIGL/DIGU - Filter Taps in DIGL and DIGU modes.

High SWR protection SWR \geq : - Trigger threshold of the transceiver's high SWR protection in the TX mode.

Warning!

ⓘ **Rising the SWR protection trigger threshold higher than 4, may lead to transceiver failure!**

5.4.1.6 CW

On the **CW** tab, you can see the settings of the additional CW keys.

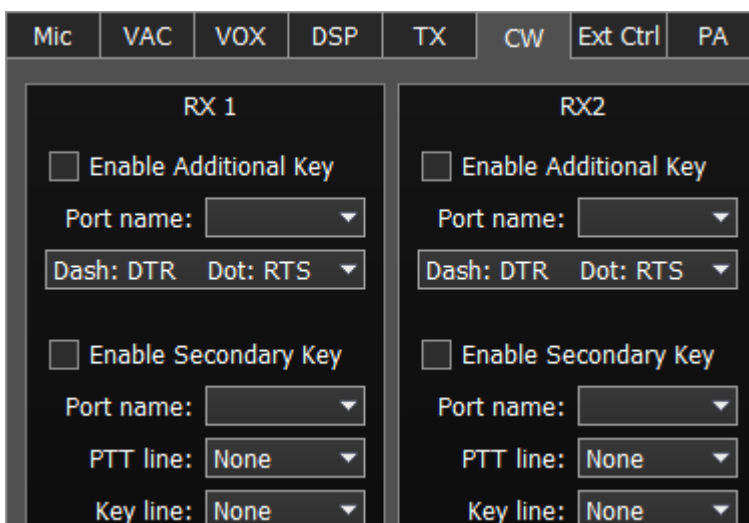

RX1, RX2 - these categories have similar settings for the RX1 and RX2 receivers.

Enable Additional Key - checkbox to enable additional CW key. Set it to enable additional iambic CW key, which is connected to the COM-port.

Port name - COM-port number, which is connected to the key.

Lines - in the Lines drop-down menu you may swap Dot and Dash signals with COM-port bits RTS and DTR.

Enable Secondary Key - checkbox to enable secondary additional CW key. Set it to enable secondary additional CW key, which is connected to the COM-port. As a rule, this port is being used for CW signal generated by the additional software (message logs, contest logs and others).

Port name - COM-port number, which is connected to the key.

PTT line - line menu, is being used to turn the transceiver to the TX mode.

Key line - line menu, is being used to generate CW signal.

5.4.1.7 Ext Ctrl

To control external devices, the transceiver has a special connector **Ext Ctrl**. Settings could be adjusted separately for the RX mode and TX mode.

The **Ext Ctrl** connector output consists of the keys with open collector. For more details on how to use the Ext Ctrl connector, look in the "**Connecting an external PA, fan, relay etc. to the SunSD2 PRO**" document.

The best way to use this feature is to switch the narrow-band filters in the RX mode and switch the LPF in the TX mode. Also, you may arrange your own antenna switch, having only the relay.

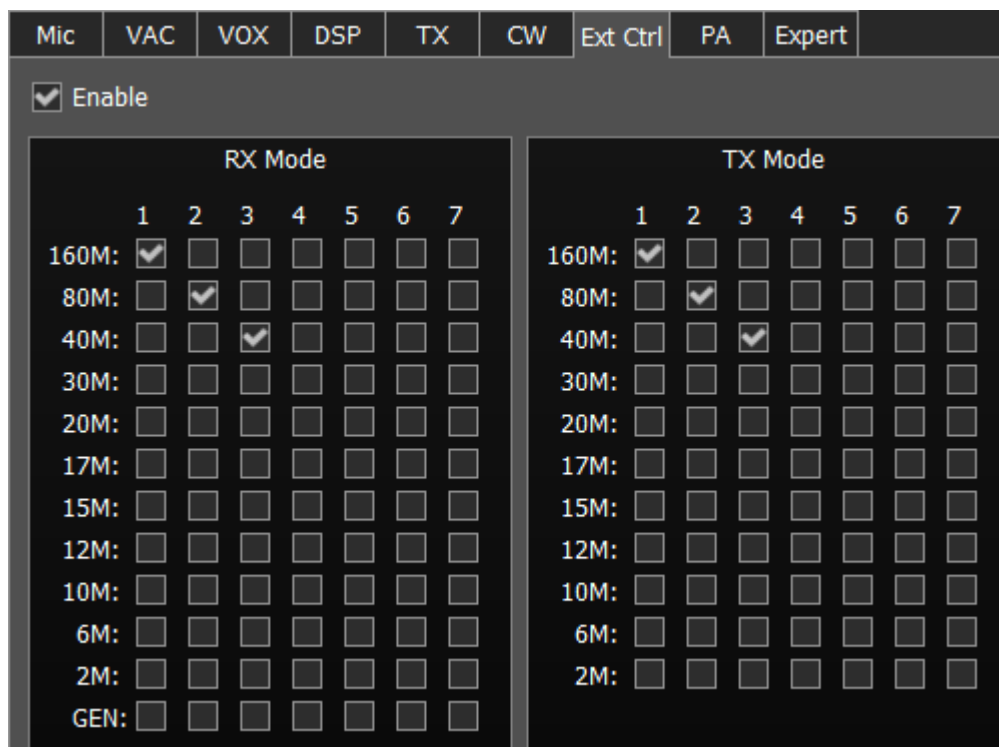

Enable - checkbox to enable control of the electronic keys.

RX Mode - electronic keys settings in the RX mode.

TX Mode - electronic keys settings in the TX mode.

1...7 - electronic keys numbers.

160...2, GEN - electronic key enable checkbox on the corresponding band.

Note:

• On the picture above, you can see the example of using the keys in the 160M, 80M and 60M bands for both RX and TX modes.

While working on the 160M band in the RX mode, #1 key is enabled, if turn to TX mode, #1 key is still active.

While turning on 80M band, #2 key will be enabled (#1 key will be disabled), it is active in both RX and TX modes.

While turning on 60M band, #3 key will be enabled (#2 key will be disabled), it is active in both RX and TX modes.

• Connecting relays to these keys, you may create an additional antenna switch, band filters switch, PA band switch etc.

5.4.1.8 PA

On the **PA** tab you can see the settings of the electronic PTT keys - which control the TX mode of the external power amplifiers (PA).

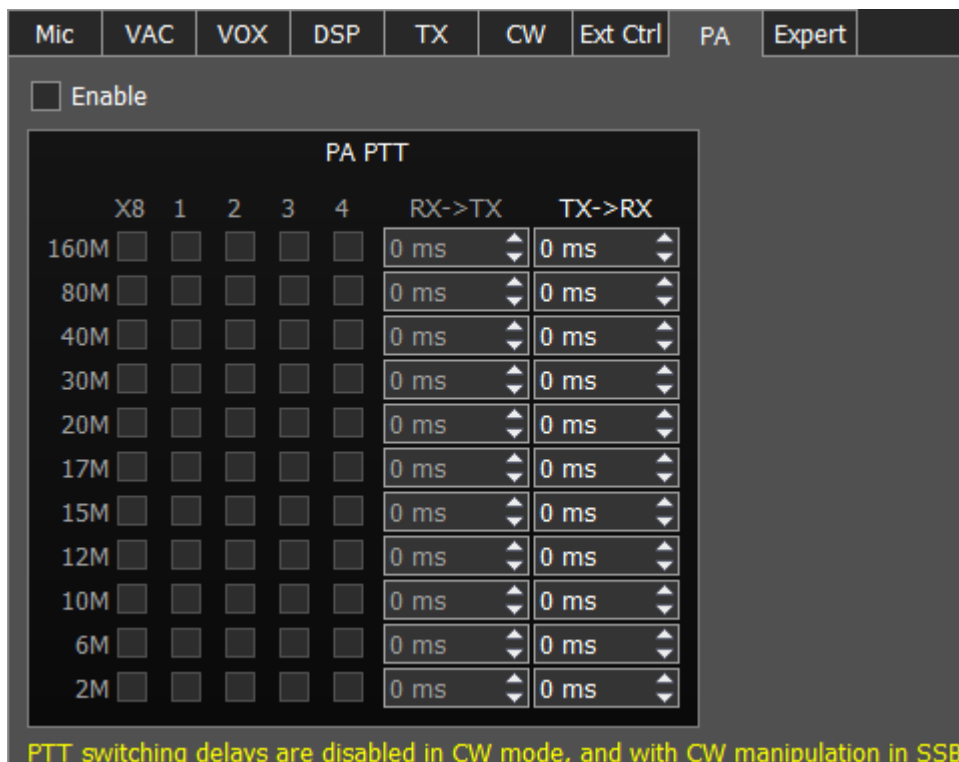

Enable - Enable control checkbox.

Set the **Enable** checkbox to work with keys.

PA PTT - PTT keys settings.

- **X8** - PTT control key over an external PA.

Key output is placed on the rear panel of the transceiver in the EXT CTRL connection. (more details in [EXT CTRL](#)^{□27}).

- **1...4** - PTT control keys over an external PAs.

Keys' outputs are placed on the rear panel of the transceiver on the corresponding connections PTT 1-4 (more details in [PA PTT outputs](#)^{□29}).

- **RX->TX** - HF signal delay after turn from RX to TX.
- **TX->RX** - turn delay from TX to RX after the PTT signal is disabled.
- **160M-2M** - Electronic keys enable checkboxes on the corresponding bands. Select the electronic keys, which will be enabled on the corresponding bands. One key could be assigned to several bands.
e.g. if you use the wide band PA for 160M-10M bands and control it with #1 key, then you should set the checkboxes for corresponding bands.

Warning:

- **PTT switching delays are disabled in CW mode, and with CW manipulation in SSB! Be careful using an external PA!**
-

1. Set the **Enable** checkbox.
 2. Connect the PTT control line of the external PA to one of the PTT sockets (more details in [Linear Amplifier](#)^{□21}).
 3. Open the software **Options-> Device** menu-> **PA** tab.
 4. Set the checkboxes for the required bands opposite the used key.
-

Note:

↴ *The same key could be used on several bands.*

Example: *If you use wide-band PA 160M-10M bands and control it via the #1 key, then set the checkboxes for the #1 key, opposite the corresponding bands.*

RX to TX delays work only with MOX (Mic and VAC) signals. Tone signals do not have RX to TX delay

5.4.1.9 Expert

On the **Expert** tab you can see the fine hardware settings of the transceiver.

Mic	VAC	VOX	DSP	TX	CW	Ext Ctrl	PA	Expert
Power Correction:								
160M	100.0	30M	100.0	12M	100.0	<input type="checkbox"/> DITH		
80M	100.0	20M	100.0	10M	100.0	<input type="checkbox"/> RAND		
60M	100.0	17M	100.0	6M	100.0			
40M	100.0	15M	100.0	2M	50.0			
Frequency coefficient:				0.000000				
SDR Firmware Update								
ATU Info								
Push WRITE button after changing coefficients.								
Default			Read			Write		

Note:

- All settings in this tab are stored in the transceiver's energy independent memory.
- After setting the required values, set/unset checkboxes, press the **Write** button to save the settings.
- To read the current settings state from the memory, press the **Read** button. Auto-read happens with every software launch.

Power Correction - output power correction menu, set the output power value for each band. Value = 100 means maximum output power of the transceiver.

Note:

- After tuning the power values, press the **Write** button.

Frequency coefficient - Correction menu of the transceiver's frequency tuning.

Set the coefficient that the transceiver's tuning frequency would be equal to the real frequency of the received signal.

Note:

- Correction of the displayed frequency could be made according to the time signals on the 4.996MHz, 9.996MHz or 14.996MHz (preferably) frequencies in the IARU region 1 and 5.0MHz, 10.0MHz, 15.0MHz in the IARU region 2, where you can find easily tracked pulse

signals. If they do not match with the tuned frequency, adjust the **Frequency coefficient** till the frequency match.

- The higher the frequency of the used time signal, the higher calibration accuracy.
 - Calibration should be performed with the maximum panorama zoom and maximum FFT size of the panorama (more detail about FFT size in [Spectrum](#) ¹⁰).
 - After you set the frequency correction coefficient, press the **Write** button.
 - The devices are calibrated at the manufacturing by default, additional calibration is not required.
-

SDR Firmware Update - Button for manual firmware update in the transceiver's SDR module. Press the **Firmware update** button to initialize firmware update process.

ATU Info - Button for manual firmware update in the transceiver's ATU module. Press the **ATU Info** button to initialize firmware update process.

DITH - Checkbox to enable the internal noise source in the ADC.

Set the **DITH** checkbox to enable internal noise source of the receiver's high-speed ADC.

Note:

- After set/unset of the **DITH** checkbox, press the **Write** button .
 - Internal noise source in the ADC gives an additional linearity to the receiver's ADC functionality. As a rule used for lab measurements for receiver's linearity with other devices.
 - While operating in real air, noise source is an actual noise of the air, that's why there is no need to enable **DITH** function.
 - If **DITH** is enabled, receiver's own noise is increased.
-

RAND - Checkbox to enable bits randomizing on the ADC's data bus.

Set the **RAND** checkbox to enable bits randomizing on the receiver's ADC data bus.

Note:

- After set/unset of the **RAND** checkbox, press the **Write** button.
 - Bits randomizing on the ADC's data bus leads to lessening the noise from this bus to the receiver.
 - It is recommended to keep this checkbox on all the time.
-

Default - Default hardware settings button.

Press the **Default** button to return to the default settings.

Read - Read the hardware settings from the transceiver's memory.

Press the **Read** button to read the hardware settings from the transceiver's memory.

Write - Store the hardware settings.

Press the **Write** button to store the hardware settings in the transceiver's memory.

5.4.2 Sound card menu

In the **Sound card** menu you can see the settings of the audio devices, which can be used with the transceiver.

5.4.2.1 Sound card

In the **Sound card** category you can see the settings of the sound card, which can be used for sound output in the RX mode.

Note:

- *Sound output via the **Sound card** will be simultaneous with the sound from the transceiver via the sound codec, placed in the SDR module.*
- ***Sound card** volume is adjusted by rotating the AF knob on the front panel of the transceiver.*
- *Delay for the signal output via the sound card could reach 250-500 ms.*

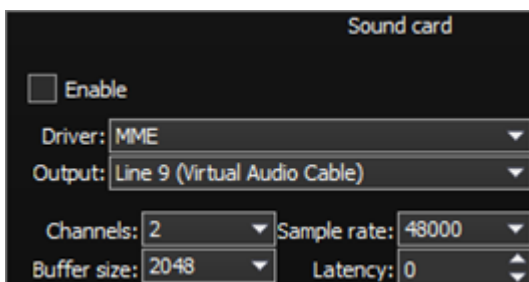

- **Enable** - Checkbox to enable PC's sound card.
Set the **Enable** checkbox to enable sound output via the sound card.
- **Driver** - Select the sound card's driver type.
- **Output** - Select the sound card's physical output.
- **Channels** - Select the amount of active sound card's channels.
- **Sample rate** - Sampling frequency.
- **Buffer size** - Buffer size.
- **Latency** - signal delay time.

Note:

- *Before you'll enable the **Sound card** by the **Enable** checkbox, make sure that all sound devices settings are set correctly.*
-

5.4.2.2 Line output

In the **Line output** category you can see the settings of the sound card or virtual audio cables, which could be used for linear sound output in the RX and TX modes, separately for RX1 and RX2 receivers.

Note:

- *Sound output via the **Line output** will be simultaneous with the sound from the transceiver.*
 - ***Line output** volume has a constant max value and can not be changed by the operator.*
 - *As a rule sound output via the **Line output** is used for recording communications on contests and other purposes.*
-

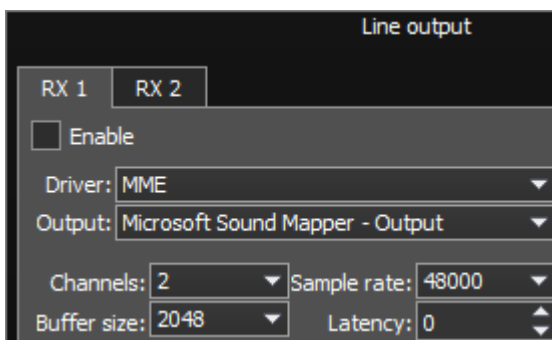

There are two tabs with identical settings for RX1 and RX2 receivers, in the **Line output** category, let's look at one of them.

- **Enable** - Checkbox to enable **Line output**.
Set the **Enable** checkbox to enable **Line output**.
 - **Driver** - Choose the sound device' driver type.
 - **Output** - Choose the sound device' physical output.
 - **Channels** - Choose the amount of active sound device' channels.
 - **Sample rate** - Sampling frequency.
 - **Buffer size** - Buffer size.
 - **Latency** - signal delay time.
-

Note:

- *Before you'll enable the **Line output** by the **Enable** checkbox, make sure that all sound devices settings are set correctly*
 - *You can use the sound card as a sound device - the signal goes out of the transceiver, you can use the virtual audio cable as a sound device - the signal goes in the transceiver in the software, which functions on the internal PC, e.g. in contest log.*
-

5.4.3 Display menu

In the **Display** menu you can see the settings of the transceiver's software display. Display settings are placed according to their functionality:

- "Main window" tab
- "Spectrum" tab
- "Waterfall" tab
- "Grid" tab
- "Filter" tab
- "Background" tab
- "Indicators" tab

5.4.3.1 Main window

On the **Main window** tab you can see the settings of the transceiver's software main window display.

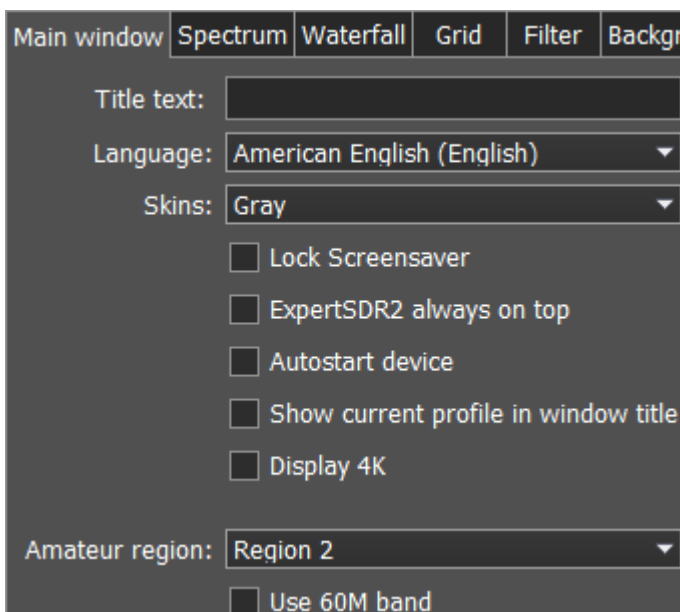

- **Title text** - Input box to enter the title.
Enter your call-sign or other information in the **Title text** box, it will always be displayed in the software title.
- **Language** - Interface language menu.
Select the required language from the list.
- **Skins** - Software color theme menu.
Select the required software color theme from the list.
- **Lock Screensaver** - Lock screen-saver checkbox.
Set the **Lock Screensaver** checkbox to block the display turn off by the Windows OS.
Recommended checkbox setting - on.

- **ExpertSDR2 stays on top** - On top checkbox.
Set the **ExpertSDR2 stays on top** checkbox to see ExpertSDR2 window constantly on top of other windows.
Recommended checkbox setting - off.
- **Autostart device** - Receiver's autostart checkbox.
Set the **Autostart device** checkbox to automatically start the receiver after the launch of the software.
Recommended checkbox setting - on.
- **Show current profile in window title** - Display the current profile in the software window title.
Set the **Show current profile in window title** checkbox to display the current profile (if the profile is on) in the software window title.
- **Display 4K** - display mode for 4K monitors.
- **Amateur region** - Amateur region menu.
Select the region you are currently in, in the Amateur region menu.

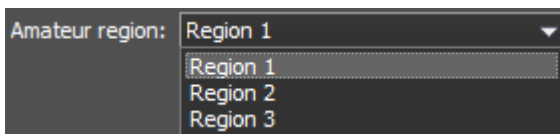

It affects the position of the amateur bands in the software.

- **Use 60M band** - set the **Use 60M band** checkbox to enable 60M band.

Note:

• After you selected the amateur region and/or set/unset the checkbox Use 60M band you'll see the notification window, that the settings will be applied after the restart of the software. Restart the software.

5.4.3.2 Spectrum

On the **Spectrum** tab you can see the transceiver's spectrum settings.

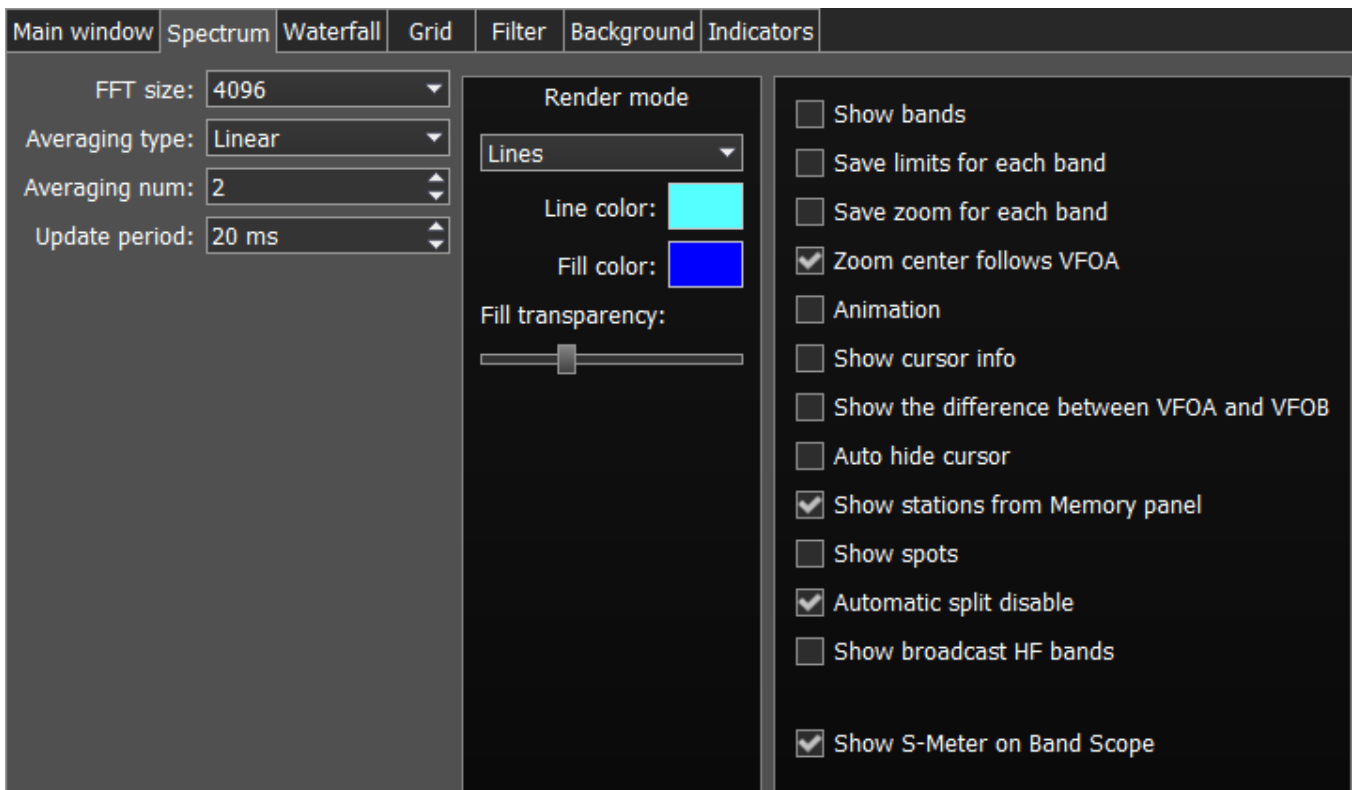

- **FFT size** - Fast Fourier Transform (FFT) size of the spectrum scope.
Select the required FFT size. The higher FFT size, the higher spectrum scope resolution by frequency, along with the higher processor load.
- **Averaging type** - Spectrum scope averaging type menu.
Select the averaging type from the list: Linear, root-mean-square (Rms), Exponential, which suits you best.
- **Averaging num** - A number of samples for averaging.
Set the required amount of samples for averaging. The bigger a number of samples, the slower the spectrum will change on the graph.
- **Update period** - Spectrum scope update period.
Set the required specter's graph update period. The bigger the number, the more FPS on the spectrum scope, along with the higher processor load.
- **Render mode** - Spectrum render mode: lines, gradient.
Set the required specter render mode.
- **Line color** - Spectrum scope line color.
Select the required line color from the palette.
- **Fill color** - Fill color of the spectrum scope lower area.
Select the required fill color from the palette.
- **Fill transparency** - Transparency slider for the spectrum scope lower area filling.
Set the required filling transparency level.

- **Show bands** - Show amateur bands borders.
Set the **Show bands** checkbox to show amateur bands borders at the top of the spectrum scope (blue line).
- **Save limits for each band** - Save spectrum scope amplitude limits for each band.
Set the **Save limits for each band** checkbox to enable the software to save set spectrum scope limits for each band.
- **Save zoom for each band** - Save spectrum scope zoom settings for each band.
Set the **Save zoom for each band** checkbox to enable the software to save spectrum scope zoom settings for each band.
- **Zoom center follows VFOA** - Zoom center marker locked on the VFOA position on the spectrum scope.
Set the **Zoom center follows VFOA** checkbox to enable the zoom center marker lock on the VFOA position.
- **Animation** - Spectrum scope animation while transitioning between bands.
Set the **Animation** checkbox to enable animation.
- **Show cursor info** - Show frequency and dB level of the cursor position.
Set the **Show cursor info** checkbox to enable info display near the cursor on the spectrum scope.
- **Show the difference between VFOA and VFOB** - Show the difference between VFOA and VFOB.
Set the **Show the difference between VFOA and VFOB** checkbox to display the difference between VFOA and VFOB near the cursor.
- **Auto hide cursor** - Automatically hide the cursor from the spectrum scope.
Set the **Auto hide cursor** checkbox to let the cursor disappear after idle 2 seconds.
- **Show stations from Memory panel** - Show the stations previously stored in the frequency memory.
Set the **Show stations from Memory panel** checkbox to show on the spectrum scope previously stored stations as markers (blue dots in the top area of the spectrum scope). When rollover the station's marker you'll see the commentary.
- **Show spots** - Show spots from the CW Skimmer on the spectrum scope.
Set the **Show spots** checkbox to show spots from the CW Skimmer on the spectrum scope as a markers with call-signs.
- **Automatic SPLIT disable** - SPLIT function is automatically disabled when you change the mode type or frequency band, VFO B frequency becomes equal to VFO A frequency.
- **Show broadcast HF bands** - enable for display of broadcast HF bands on panorama and Band Scope.
- **Show S-Meter on Band Scope** - Show the S-Meter on the Band Scope.
Set the **Show S-Meter on Band Scope** checkbox to show the S-Meter on the Band Scope for each VFO.

5.4.3.3 Waterfall

On the **Waterfall** tab you can see the transceiver's waterfall settings.

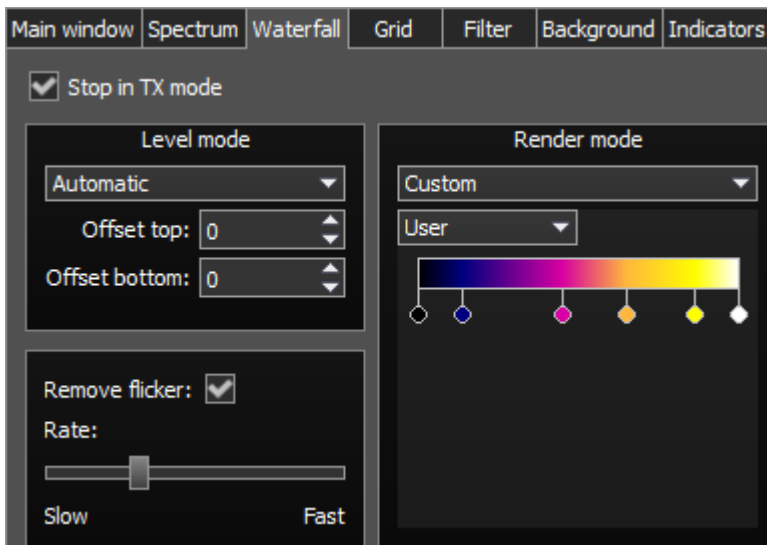

- **Stop in TX mode** - Stop the waterfall in TX mode.
Set the **Stop in TX mode** checkbox to disable the waterfall while transmitting.
- **Level mode** - Waterfall bright menu.
Select the bright mode from the list: Automatic, Synchronous.
Automatic mode depends on air signals and set offset in the settings below.
Synchronous mode depends on the set limits of the spectrum amplitude.
- **Offset top** - Offset input box by the top dB level relatively to signals level.
Set the offset in the **Offset top** box to determine the maximum brightness relatively to the max signals' levels.
- **Offset bottom** - Offset input box by the bottom dB level relatively to signals level.
Set the offset in the **Offset bottom** box to determine the minimum brightness relatively to the min signals' levels.
- **Render mode** - waterfall render mode menu: Rainbow, Monochrome, Custom. Select the required color render of the waterfall, depending on your choice or tasks. In the Custom mode, you have three colors presets: 1,2,3 and User adjustable mode.
In the User preset there are 6 color markers at maximum. Double click of the left mouse button on the color marker opens the color menu, double click of the right mouse button on the color marker delete it. Double click of the left mouse button on the empty space adds the color marker.
- **Remove flicker** - Checkbox to remove the waterfall flickers.
Set the **Remove flicker** checkbox to get rid of the texture flickers in the waterfall, also it slightly clears the waterfall from air noises.
- **Rate** - Waterfall movement speed slider.
Set the **Rate** slider according to the required waterfall movement speed.

5.4.3.4 Grid

On the **Grid** tab you can see the spectrum scope grid display settings.

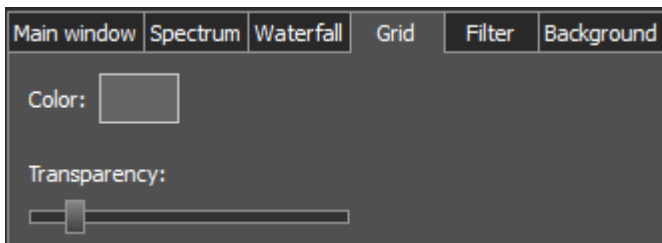

- **Color** - Color of the spectrum scope grid.
Select the required grid color from the palette.
- **Transparency** - Grid transparency slider.
Set the required grid transparency by moving the slider.

5.4.3.5 Filter

On the **Filter** tab you can set the required color of filters and the necessity to display the additional text information.

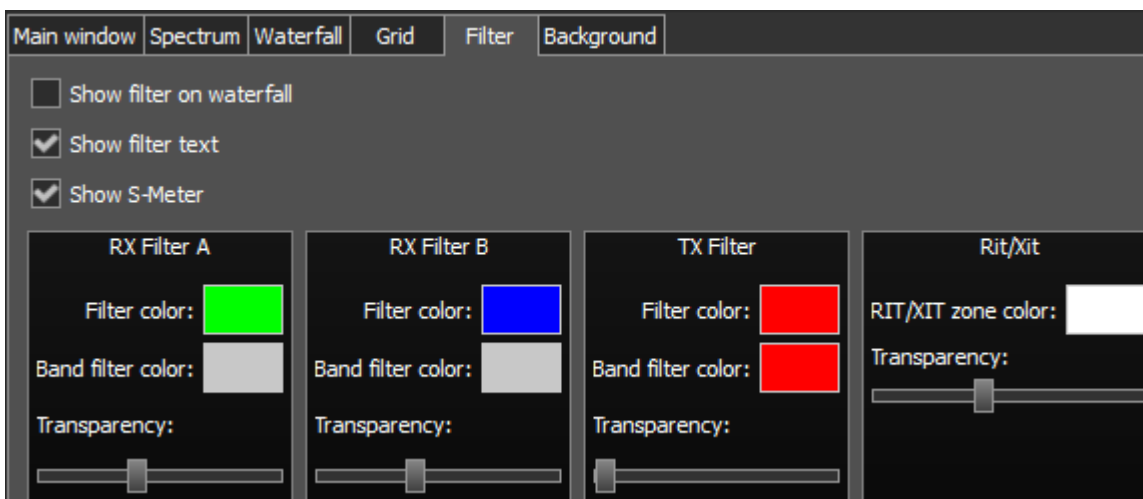

- **Show filter on waterfall** - Show receiver(s) filter on the waterfall.
Set the **Show filter on waterfall** checkbox to show receiver(s) filter on the waterfall.
- **Show filter text** - Show text info near the receiver's filter on the spectrum.
Set the **Show filter text** checkbox to display filter's tuned frequency, signal level in S-units etc. in the used filter bandwidth.
- **Show S-Meter** - Enable animated S-Meter near the receivers' filter on the spectrum.
Set the **Show S-Meter checkbox** to display S-Meter near the receiver's filter.

In the **RX Filter A**, **RX Filter B**, **TX Filter** categories displayed filters' color and transparency settings.

- **Filter color** - Filter's frequency color menu.
Choose the required filter's tuned frequency color from the palette.
- **Band filter color** - Filter's bandwidth color menu.
Choose the required filter's bandwidth color from the palette.
- **Transparency** - Filter's transparency slider.
Set the required filter's transparency.

In the **Rit/Xit** category displayed RIX/XIT active zone settings.

- **Rit/Xit zone color** - RIX/XIT active zone color menu.
Choose the required RIX/XIT active zone color from the palette.
- **Transparency** - RIX/XIT zone transparency slider.
Set the required RIX/XIT zone transparency.

5.4.3.6 Background

On the **Background** tab you can see the spectrum scope background settings.

Background type - Spectrum scope background type menu: **Solid**, **Gradient**, **Image**.
Select in the **Background type** menu spectrum scope background render type.

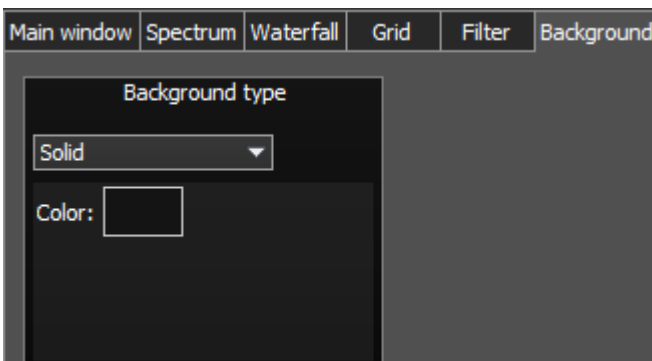

In the **Solid** mode available settings are:

- **Color** - Background color menu.
Choose the required background color from the palette.

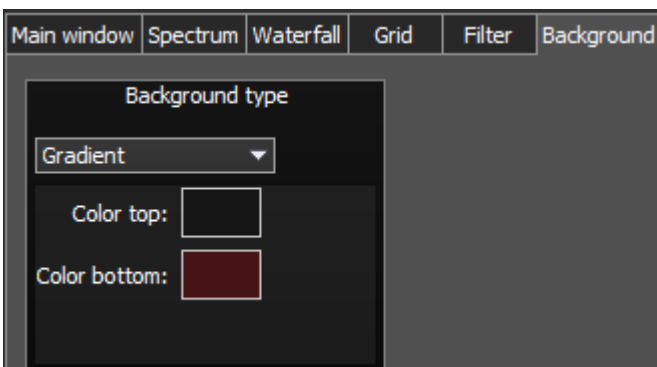

In the **Gradient** menu available settings are:

- **Color top** - Top gradient color of the background.
Choose the required top gradient color from the palette.
- **Color bottom** - Bottom gradient color of the background.
Choose the required bottom gradient color from the palette.

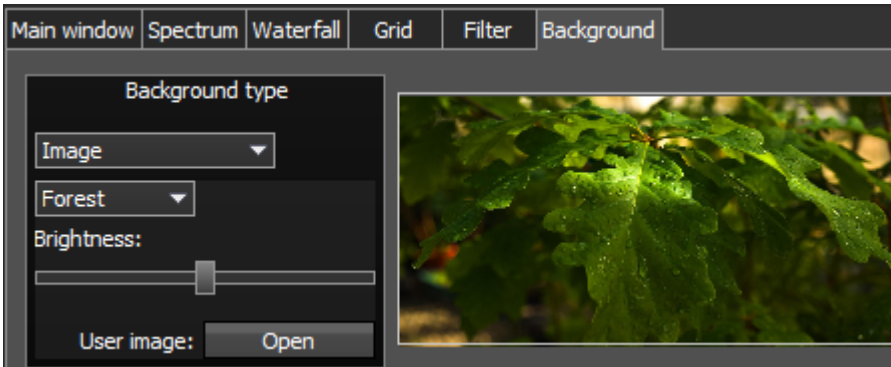

In the **Image** menu available settings are:

- **Image menu** - Image presets menu (Forrest, Bubbles, Space, Water, User).
Pick the required image from the menu or lock one of your own images.
- **Brightness** - Background image brightness slider.
Set the required background image brightness.
- **User image** - Choose the required image to be displayed on the background.
Press the **Open** button, in the opened window choose the image file to set as the background.

Note:

• If the image file wasn't chosen previously via the **Open** button, then if you choose the User image in the presets list it'll open the window to choose the image file.

• Supported files types: png, jpg, jpeg, bmp.

5.4.3.7 Indicators

In the **Indicators** tab you can change the algorithm of the output power readings on the transmitter output.

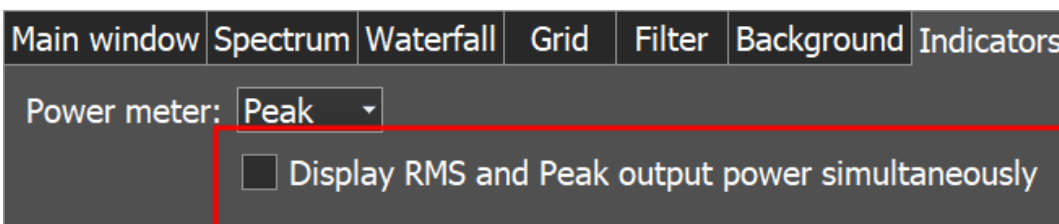

In the Peak/RMS drop-down menu you set the type of output power which is displayed on the Power and S-meters. What you check there always displayed as text on the Power meter.

Display RMS and Peak output power simultaneously - check to see both **Peak** and **RMS** indicators on Power meter and S-meter. If checked, the **Peak** power displayed as **orange** indicator on the Power meter and **red** needle on the S-meter.

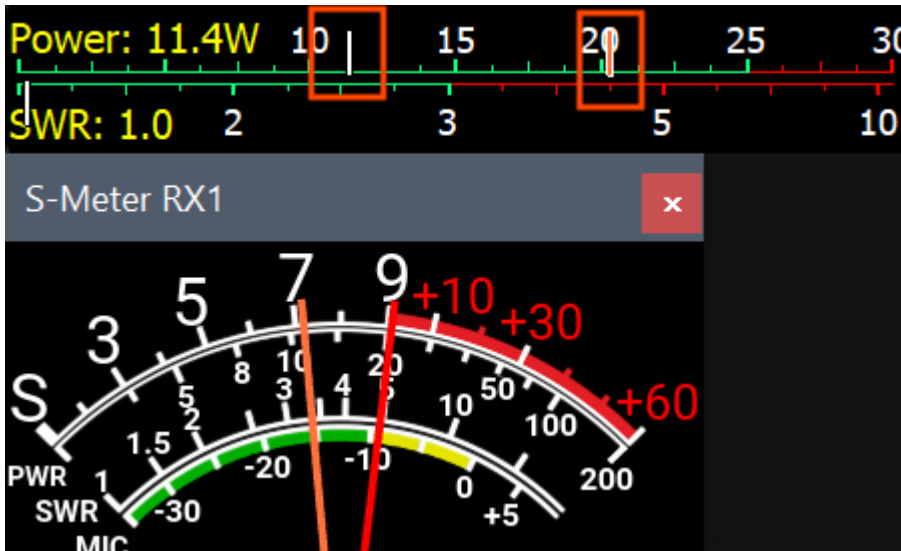

5.4.4 CAT menu

In the **CAT** menu, you can see the CAT-system settings. CAT-system is the transceiver's exchange interface with external devices and software.

CAT-interface is used for control of the transceiver from a third-party software. This could be contest logs, digital modes decoder-software, SAT-tracker etc. RX1 and RX2 have independent settings and could be controlled separately via the CAT-protocol.

5.4.4.1 ECATv1

ECATv1 - exchange protocol compatible with TS-480 transceiver. This protocol allows exchanging data with external devices and software via COM-port.

- **Enable CAT** - Checkbox to enable control of the transceiver via the CAT-system.
- **Port name** - COM-port number.
- **Parity** - Parity.
- **Data** - Amount of data in bits.
- **Stop bit** - Amount of stop bits.
- **Baud rate** - Port speed.
- **PTT line** - COM-port line to activate the TX mode.
- **Key line** - COM-port line for the CW mode.
- **DTR/RTS** - COM-port line for the PTT mode.
- **Enable SubRX control (FR command)** - Checkbox to enable control of the sub-receiver via the CAT-system.
Set the **Enable SubRX control (FR command)** checkbox to enable the control of the sub-receiver via the CAT-system.
- **Antenna switch control** - Checkbox to enable control of the antenna switch via the CAT-system.
Set the **Antenna switch control** checkbox to enable the control of the antenna switch via the CAT-system. Useful for the Ham Radio Deluxe software.
- **Global volume control** - When this checkbox is enabled, you control the global volume with the Volume slider, on the top of the software window, from the CAT-system. Recommended when you use one RX or VFO A only, SubRX is disabled.
- **Enable PTT** - Checkbox to enable control of the TX mode via the COM-port.
Set the **Enable PTT** checkbox to enable the control of the TX mode via the COM-port.

- **Port name** - COM-port number.
- **DTR/RTS** - COM-port line for receiving the PTT commands.
Set one of the **DTR/RTS** line checkboxes to select them as a control.
- **Enable Footswitch** - Checkbox to enable control of rerouting the PTT signal from footswitch to additional COM-port.
Set the **Enable Footswitch** checkbox to enable rerouting of the PTT signal from footswitch to additional COM-port.
- **Port name** - COM-port number.
- **DTR/RTS** - COM-port line for receiving the PTT commands.
Set one of the **DTR/RTS line** checkbox to select them as a control.
- **View log** - display CAT command log.

5.4.4.2 OmniRig

There is an experimental function to synchronize any of our devices with an external device via the [OmniRig](#) software.

OmniRig - exchange protocol via the OmniRig software.

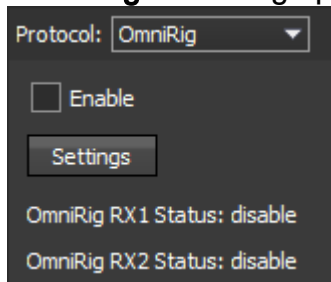

Note:

Using the OmniRig software you can send a limited set of control commands.

Available control commands:

Set VFO frequency, if no VFOB in the CAT protocol;

Set VFO A frequency;

Set VFO B frequency;

Enable receiver's RIT offset;

Set RIT offset; - Reset RIT offset;

Enable transceiver's XIT offset;

Set mode type;

Enable SPLIT.

In the **OmniRig** menu you can find the settings of the OmniRig software.

Enable - set the **Enable** checkbox to control the receiver via the OmniRig software.

Settings - press the **Settings** button to open the OmniRig software settings.

Note:

If the ExpertSDR2 software uses OmniRig protocol to exchange data with an external contest log software, which also uses OmniRig, then COM-port and other settings in the OmniRig software are not required. Select in the OmniRig settings any idle COM-port in the system, to avoid conflict.

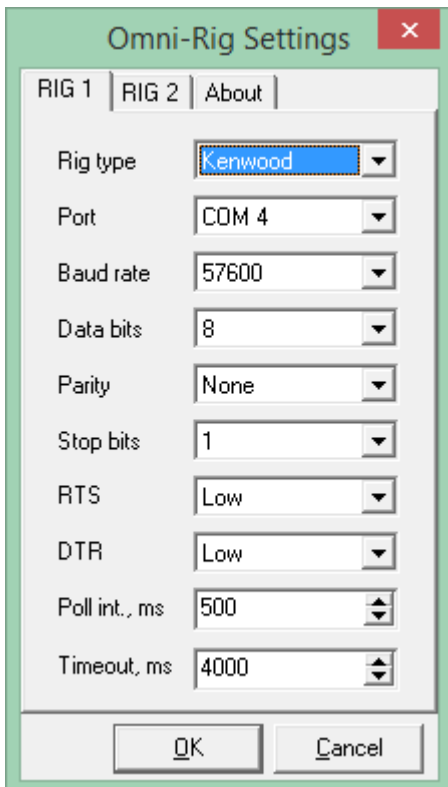

OmniRig RX1 Status - RX1 receiver and OmniRig connection status.

OmniRig RX2 Status - RX2 receiver and OmniRig connection status.

5.5 Panel menu

In the **Panel** menu you can see the settings of the E-Coder control panel.

In the drop-down Device menu, you can select the type of the connected control panel. In the meantime only one type is available - E-Coder.

Note:

*If one E-Coder panel is connected to the transceiver in the **Panel** menu displayed one **E-Coder 1** tab, if a several E-Coder panels are connected to the transceiver in the **Panel** menu displayed a several tabs **E-Coder 1**, **E-Coder 2** etc. with identical settings for each panel.*

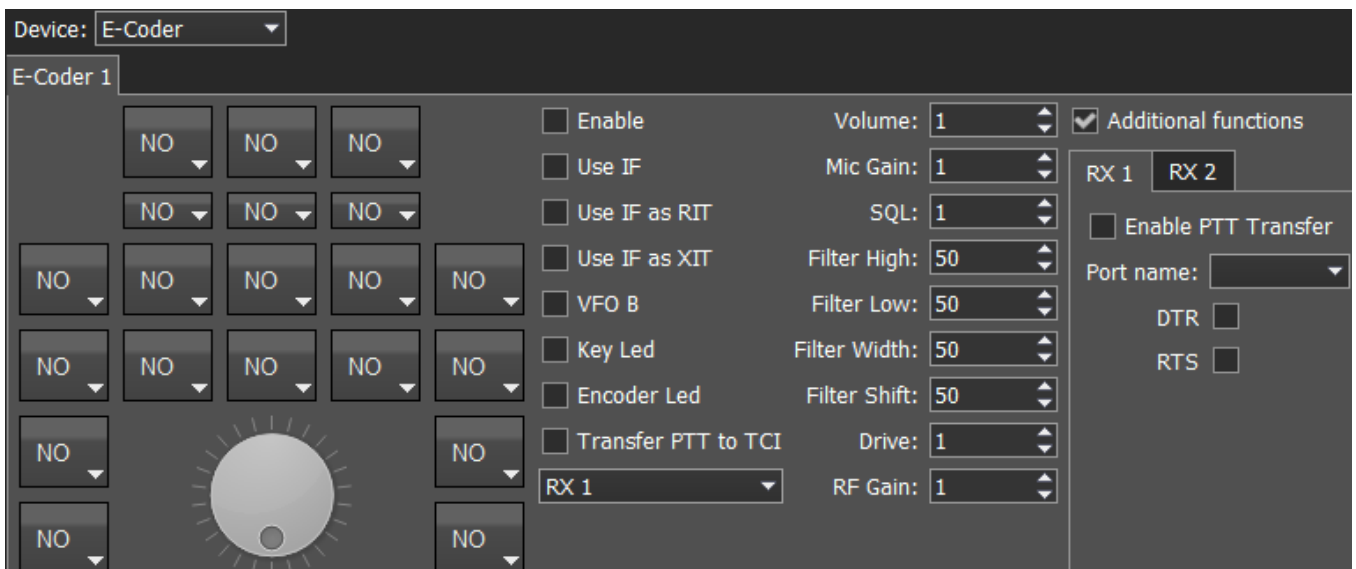

In the left part of the menu you can see the schematic picture of the E-Coder panel with buttons and knobs. Press any button, you'll see the list of the available functions.

Note:

- The list of the available functions is constantly growing. Keep track of the software updates.
- You can make a request to add a new function on the control button.

The following functions may be assigned to the E-Coder panel buttons:

Unused - button is unused.

Main:

AGC Up/Down - AGC type switching.

Band Up/Down - band switching.

Filter Up/Down - receiver's filter switching.

Mode Up/Down - mode switching.

MOX - enable/disable manually operated transmit mode.

PA - enable/disable power amplifier.

Preamp Up/Down - preamp or attenuator level switching.

Power ON/OFF - transceiver's power on/off.

RX ANT - enable/disable receive antenna.

Step Up/Down - change the tuning step.

Tone - enable/disable tone signal in TX mode.

WF - enable/disable **Wide Filter**. Filter for all Nyquist zone. If in the **Device** menu settings, you set **Auto enable** checkbox, then you don't need this function on the panel.

Zoom In/Out - spectrum zoom modes switching.

VFO/RX2:

A>B - assign the frequency from heterodyne VFO A to heterodyne VFO B.

B>A - assign the frequency from heterodyne VFO B to heterodyne VFO A.

B<>A - frequency exchange between VFO A and VFO B.

Change VFO A/VFO B - switching between VFO A and VFO B.

IF as RIT - tune the RIT offset by moving the filter over the panorama.

LOCK - lock the frequency tuning.

RX2 On/Off - enable/disable RX2.

RIT On/Off - enable/disable RIT offset.

RIT Reset - reset RIT offset to 0.

Sub RX On/Off - enable/disable SubRX.

Split - enable/disable Split mode.

Switch DDS/IF - tuning the frequency by moving the filter over the panorama, in other words changing the digital IF, or when filter stands still and spectrum moves, this is the central frequency tuning.

Switch Receiver - switching between software RX1 and RX2. The main knob will tune the frequency of one of the receivers.

XIT On/Off - enable/disable XIT offset.

XIT Reset - reset XIT offset to 0.

While you operate both RX1 and RX2, usually you need to listen to either only one of them or both of them, but in different channels (left / right). To do that we added special functions to the E-Coder panel, which set the mixer for both RXs.

Audio:

Listen both RX1, RX2 - default settings, both RXs have equal volume in both channels.

Listen RX1 only - listen to the RX1 in both channels.

Listen RX2 only - listen to the RX2 in both channels.

Listen RX1 in left channel, RX2 in right - listen to the RX1 in the left channel and RX2 in the right channel.

Listen RX1 in right channel, RX2 in left - listen to the RX1 in the right channel and RX2 in the left channel.

Similar settings were added for VFOs:

Listen both VFO A/B - default settings, both VFOs have equal volume in both channels.

Listen VFO A only - listen to the VFO A in both channels.

Listen VFO B only - listen to the VFO B in both channels.

Listen VFO A in left channel, VFO B in right - listen to the VFO A in the left channel and VFO B in the right channel.

Listen VFO A in right channel, VFO B in left - listen to the VFO A in the right channel and VFO B in the left channel.

Mute - switch off the sound.

Switch RX and mute former - change the software receiver and mute former one.

TX/Play - turn to TX and play the signal record in air.

Voice recording - enable/disable voice recording.

Volume Up/Down - volume adjustment.

DSP:

ANF - enable/disable auto notch filter.

APF - enable/disable analog pick filter.

BIN - enable/disable binaural mode.

NR - enable/disable noise reduction.

NB1 - enable/disable noise blanker 1.

NB2 - enable/disable noise blanker 2.

SQL - enable/disable squelch.

The following functions may be assigned on the E-Coder panel knobs:

Unused - encoder is unused.

Volume - volume adjustment.

Mic Gain - Mic gain adjustment.

SQL - squelch threshold adjustment.

Filter Low/High - tuning the frequency of the low/high filter's front.

Filter Width - adjusting the filter width.

Filter Shift - shifting the filter's central frequency.

Drive - adjusting the output power.

IF - tuning the frequency by moving the filter over the panorama.

RF Gain - RF Gain control.

CW Speed - CW Speed control.

RIT Offset - adjusting the RIT Offset.

XIT Offset - adjusting the XIT Offset.

In the right part of the menu you can see the main panel settings:

Enable - enable E-Coder panel control.

Use IF - frequency tuning by moving the filter over the panorama.

Use IF as RIT - tuning by IF when the RIT offset is on.

Use IF as XIT - tuning by IF when the XIT offset is on.

VFO B - enable sub-receiver.

Key Led - enable backlit keypad.

Encoder Led - enable backlit encoder.

Transfer PTT to TCI - enable reroute of the PTT signal from the panel to TCI, has higher priority than **COM-port PTT transfer** (described below).

RX1/RX2 menu - switching between RX1 and RX2 receivers, or assign an exact E-Coder panel to your receiver.

Volume - set the volume change step, per knob's clack.

Mic Gain - set the Mic gain change step, per knob's clack.

SQL - set the squelch threshold change step, per knob's clack.

Filter High - set the filter's high limit change step, per knob's clack.

Filter Low - set the filter's low limit change step, per knob's clack.

Filter Width - set the filter's width change step, per knob's clack.

Filter Shift - set the filter's shift change step, per knob's clack.

Drive - set the output level power change step, per knob's clack.

RF Gain - set the RF gain step, per knob's clack.

Additional functions:

RX1/RX2 tab - COM-port settings tab for rerouting the PTT signal from the panel to the COM-port.

Enable PTT Transfer - rerouting of the PTT signal from the panel to the COM-port. Set the **Enable PTT Transfer** checkbox to enable rerouting the PTT signal.

Port name - COM-port number.

DTR/RTS - select the COM-port line, which is used for transferring the PTT commands. Set one of the DTR/RTS line checkboxes to set it as the control line.

There are three LEDs on the E-Coder panel, from left to right:

- 1) Lights **green** when the VFO B is active
- 2) Lights **red** when on TX
- 3) Lights **orange** when the RX2 is active

5.6 Features menu

In the **Features** menu you can set other programs to be launched along with the ExpertSDR2.

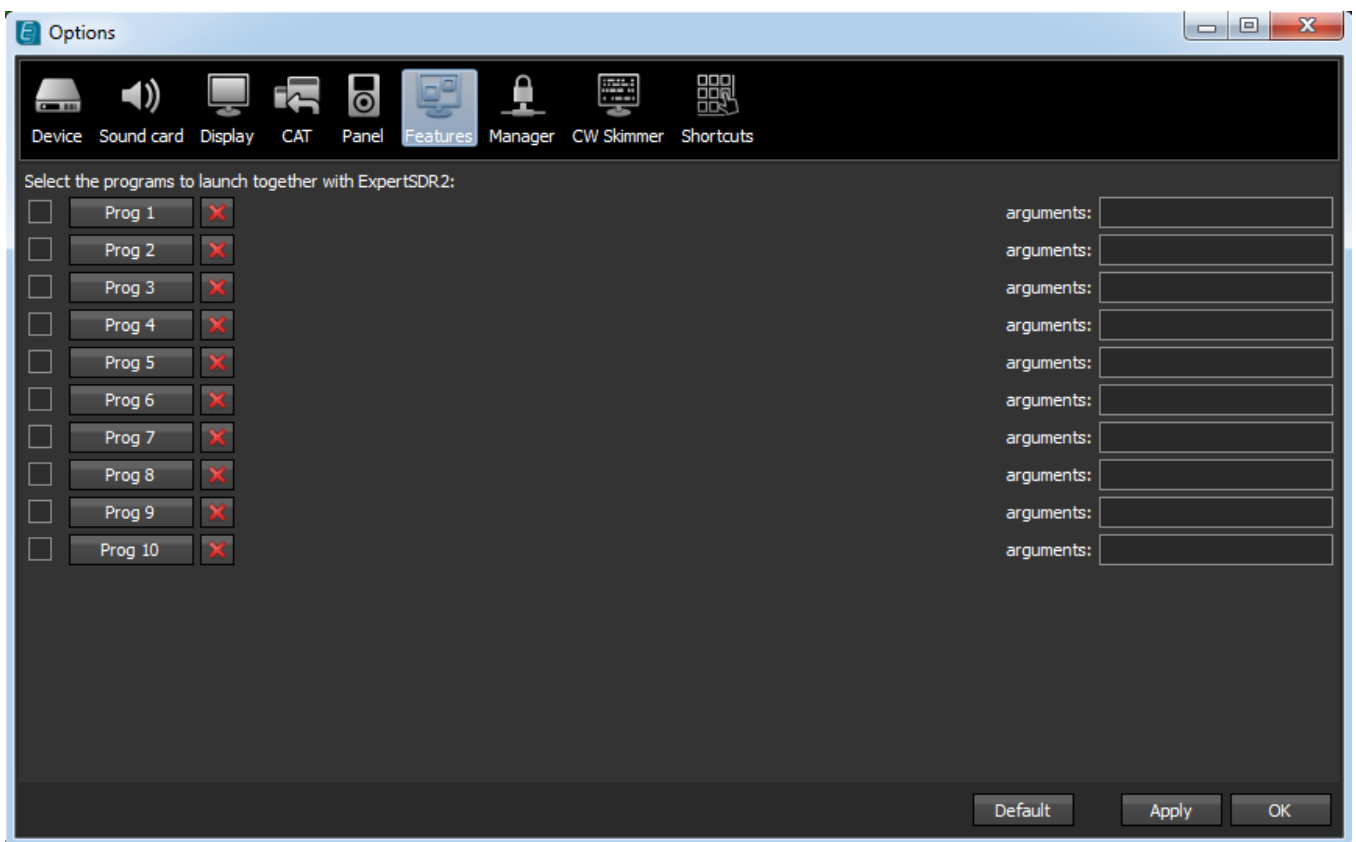

Enable checkbox - Enable autorun.

Set the **Enable** checkbox in front of the corresponding program in the list.

Program 1-10 - program's button.

Press the **Prog X** button to open the File explorer and select .exe file of the required program.

Delete button - Delete program.

Press the **Delete** button if you want to remove a program from the autorun list.

Arguments - Argument input box.

Enter some text in the **arguments** input box for the corresponding program.

Note:

- Arguments allow to the same program to be launched with different settings files etc.
- Read an instruction for your software, to know which arguments are supported.

5.7 ExpertSync menu

In the **ExpertSync** menu you can see the network synchronization settings between the MB1 and other Expert Electronics devices.

This interface allows you to synchronize the tuning frequency, mode type and RX/TX between several Expert Electronics devices via the ExpertSync software ([you may download it from here](#)).

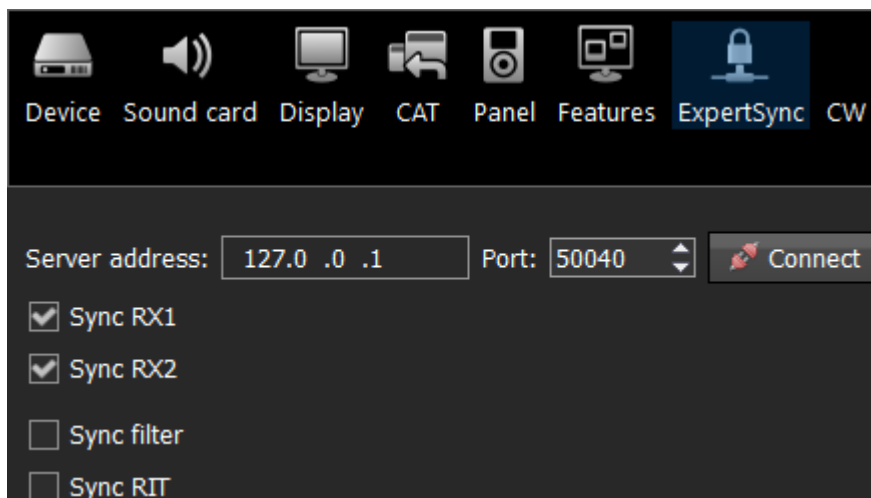

- **Server address** - ExpertSync server IP address.
Enter the ExpertSync server IP address. If the the ExpertSync server is launched on the MB1, then the address will be 127.0.0.1.
- **Port** - Data exchange port.
Enter the exchange port number in the **Port** input box.
- **Connect** - Start the connection.
Press the **Connect** button to launch the connection between the transceiver's software and ExpertSync. Blue indicator means there is a connection.
- **Sync RX1** - RX1 receiver sync button.
Set the **Sync RX1** checkbox to synchronize the RX1 receiver with the remote RX1 receiver.
- **Sync RX2** - RX2 receiver sync button.
Set the **Sync RX2** checkbox to synchronize the RX2 receiver with the remote RX2 receiver.
- **Sync filter** - set the **Sync filter** checkbox to synchronize the filter bandwidth with the other device connected via the ExpertSync software.
- **Sync RIT** - set the **Sync RIT** checkbox to synchronize the receive frequency offset (RIT) with the other device connected via the ExpertSync software.

5.8 CW Skimmer menu

In the **CW Skimmer** menu, you can see the connection settings between the transceiver software and CW Skimmer software or Internet server-spotter.

Settings in the **CW Skimmer** menu has two identical tabs RX1 and RX2 with connection settings for each software receiver, let's take a look at one of them.

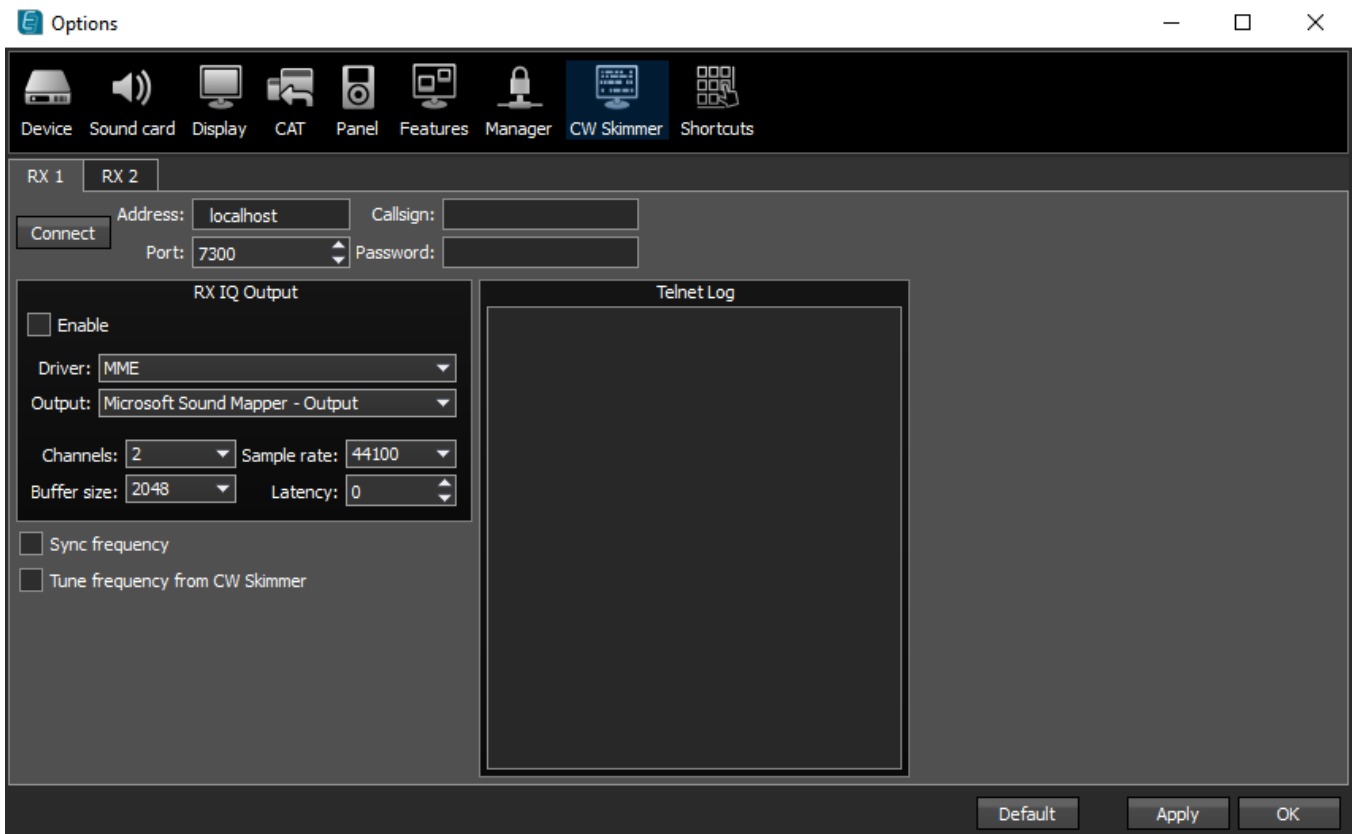

- **Connect** - Button to launch the connection with the CW Skimmer software or Internet server-spotter.
Press the **Connect** button, after adjusting all settings, to make a connection with the CW Skimmer software or Internet server-spotter.
- **Address** - IP address or DNS name of the CW Skimmer/server.
Enter this 127.0.0.1 address or localhost, if you want to connect to the CW Skimmer, which is installed on the transceiver's PC.
- **Port** - Data exchange port.
Enter the exchange port number in the **Port** input box.
- **Callsign** - Callsign input box.
Enter your callsign if the server requires it.
- **Password** - Password.
Enter the password if the server requires it.

To transfer the IQ signal in the CW Skimmer you need to adjust the settings of the audio device in the **RX IQ output** category, it consists of:

- **Enable** checkbox - Enable the IQ signal transfer from the EpertSDR2 to the CW Skimmer.
- **Driver** - Audio device driver type.
- **Output** - Audio device physical output.
- **Channels** - Amount of the used channels of the audio device.
- **Sample rate** - Sampling frequency.
- **Buffer size** - Buffer size.
- **Latency** - Signal delay time.

Note:

• If CW Skimmer is installed on the transceiver's PC, then for the signal output you need to use Virtual Audio Cable.

- **Sync frequency** - set the **Sync frequency** to synchronize the CW Skimmer frequency with ExpertSDR2 frequency.
- **Tune frequency from CW Skimmer** - CW Skimmer set the ExpertSDR2 frequency. Set the **Tune frequency from CW Skimmer** to tune the ExpertSDR2 frequency by the mouse click on the station in the CW Skimmer.

5.9 Shortcuts menu

In the **Shortcuts** menu, you can see the shortcut key combinations settings.

With the key combinations, you can control the transceiver from your keyboard.

Note:

• Shortcuts will be active only if the transceiver's software window is in focus.

<input checked="" type="checkbox"/> Enable			
Command	Shortcut	Shortcut RX1	Shortcut RX2
Start Software	Press shortcut		
Options	Press shortcut		
RX2	Press shortcut		
Bandscope	Press shortcut		
Memory Panel	Press shortcut		
Increase Sample Rate	Press shortcut		
Decrease Sample Rate	Press shortcut		
Set RX Antenna	Press shortcut		
Set TX Antenna	Press shortcut		
Mute	Press shortcut	Press shortcut	Press shortcut
RF Gain Up		Press shortcut	Press shortcut
RF Gain Down		Press shortcut	Press shortcut

- **Enable** - Enable shortcuts.
Set the **Enable** checkbox to activate assigned shortcuts.
- **Command** - Functions column.
In the **Command** column displayed all transceiver's functions available for shortcuts.
- **Shortcut** - Main shortcuts column.
In the **Shortcut** column you can set the main transceiver's functions.
- **Shortcut RX1** - RX1 receiver shortcuts column.
In the **RX1 shortcut** column you can set RX1 receiver functions.
- **Shortcut RX2** - RX2 receiver shortcuts column.
In the **RX2 shortcut** column you can set RX2 receiver functions.
- **Press shortcut** - Shortcut button.
Press the **Shortcut** button, then press the key combination on the keyboard.
- To delete a shortcut, press the Del button on the keyboard.

5.10 IQ Recorder menu

In the **IQ Recorder** menu, you can select a folder where you will store IQ recordings.

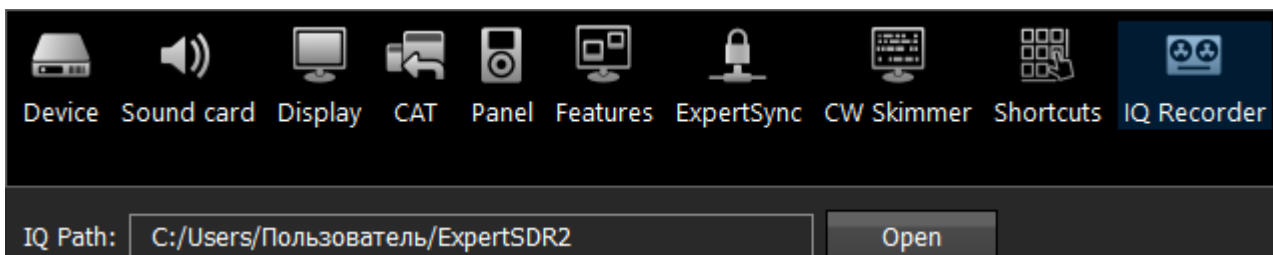

This is the first step on a way to a complete IQ Player.

5.11 TCI menu

In the **TCI** menu, you can select a port for TCI connection of ExpertSDR2 with a third-party software, with TCI support, and set the **Enable** checkbox.

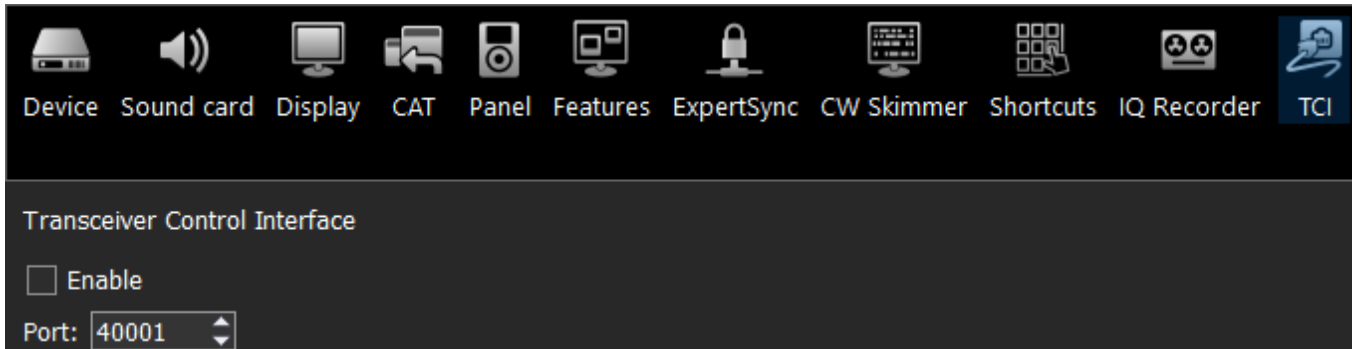

TCI - Transceiver Control Interface was developed by Expert Electronics company, for simple and still advanced connection between the ExpertSDR2 and third-party software. TCI has all required control commands similar to CAT system, but even more, it can transfer IQ-streams from the ExpertSDR2 to clients (third-party software such as signal Skimmers, etc) via local network and the Internet, CW macroses and Audio In/Out streams for digital modes (will be added soon). TCI is the universal multi-client interface (you can connect it to Loggers, Skimmers, PAs, Antenna switches etc. at the same time).

<https://github.com/maksim1210/TCI> - link to the list of files with the description of the interface in English and Russian and source code of the demo-client software with TCI support.

5.12 Spot settings menu

In the **Spot settings** menu, you can adjust spot settings you receive from CW Skimmer and telnet clusters.

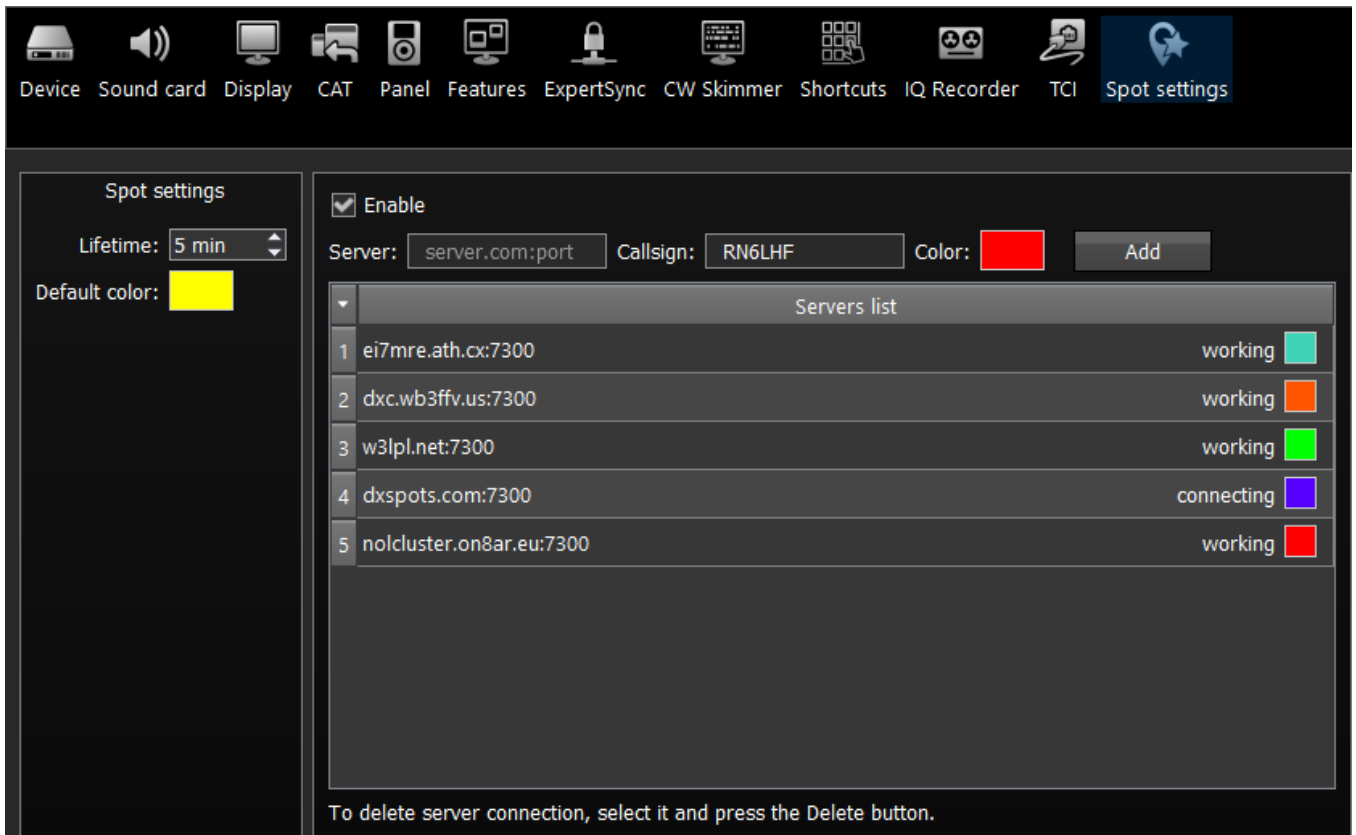

In the **Spot settings** section (left part of the menu) you can set up **Lifetime** and **Default color** for spots received from CW Skimmer.

In the right half of the menu you can add connections to telnet clusters to receive spots. To add a cluster, enter a server address (you may find examples on this website <http://www.dxcluster.info/telnet/index.php>), enter your callsign and select a certain color, press the **Add** button, it's done.

To delete a server connection, select it and press the Delete button on your keyboard.

Note:

• Don't forget to enable the *Show spots* checkbox in the [Spectrum tab](#) ^{D110}.

5.13 MB1 Utility

MB1 Utility is the support program which is constantly active along with the main ExpertSDR2 software. It's purpose is to collect system sensor's data and control rerouting of the sound paths of the audio switch.

MB1 Utility icon is in the system tray. MB1 Utility has following tabs:

5.13.1 Main

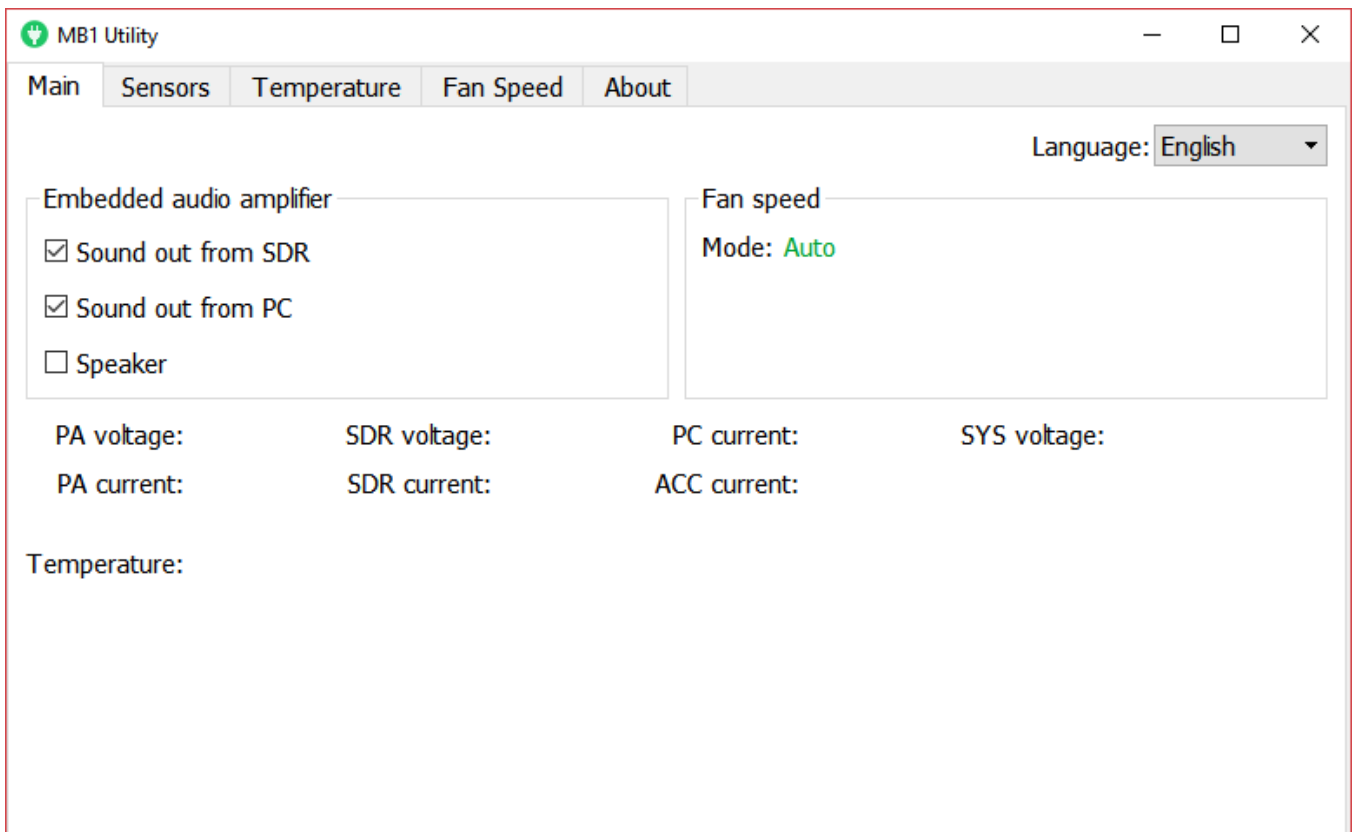

Language - Language menu of the MB1 utility.

Select the required interface language. Two languages are available: Russian and English.

Embedded audio amplifier category:

Sound out from SDR - Audio output from the SDR-module in the mixer.

Set the **Sound out from SDR** checkbox, to route audio output from the SDR-module's codec into the internal speaker and/or headphones via the **PHONES** jack. Use it when you are on the air.

Sound out from PC - Audio output from the internal PC in the mixer.

Set the **Sound out from PC** checkbox, to route audio output from the internal PC into the internal speaker and/or headphones via the **PHONES** jack. Use it to listen to the saved music, movies, when you watch video online.

Speaker - Internal speaker.

Set the **Speaker** checkbox to enable/disable the internal speaker.

Note:

•Checkboxes are doubled by buttons in the software main window in the Mixer local panel (more details in [MIXER](#)).² In other words, you don't have to open the MB1 utility to control audio output, you can do it in the ExpertSDR2 software.

Fan speed category.

Mode - Fan mode indicator.

Fan indicator shows current fan mode.

PA voltage - PA voltage indicator.

PA current - PA current consumption indicator.

SDR voltage - SDR-module voltage indicator.

SDR current - SDR-module current consumption indicator.

PC current - PC current consumption indicator.

ACC current - Accessories current consumption indicator.

SYS voltage - Power supply output voltage indicator.

Temperature - Transceiver temperature indicator.

5.13.2 Sensors

On the **Sensors** tab you can see voltage and current diagrams.

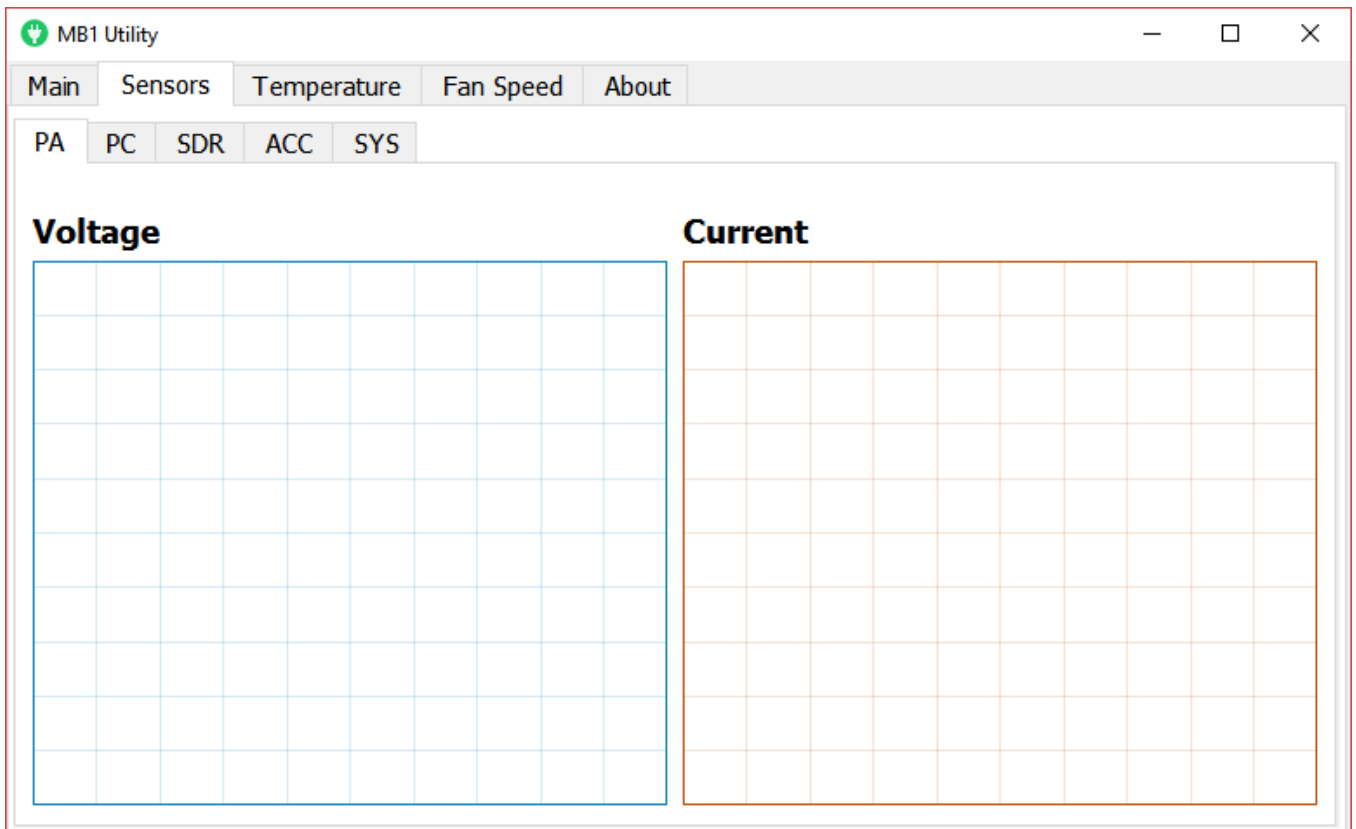

5.13.3 Temperature

On the **Temperature** tab you can see the temperature sensor diagram.

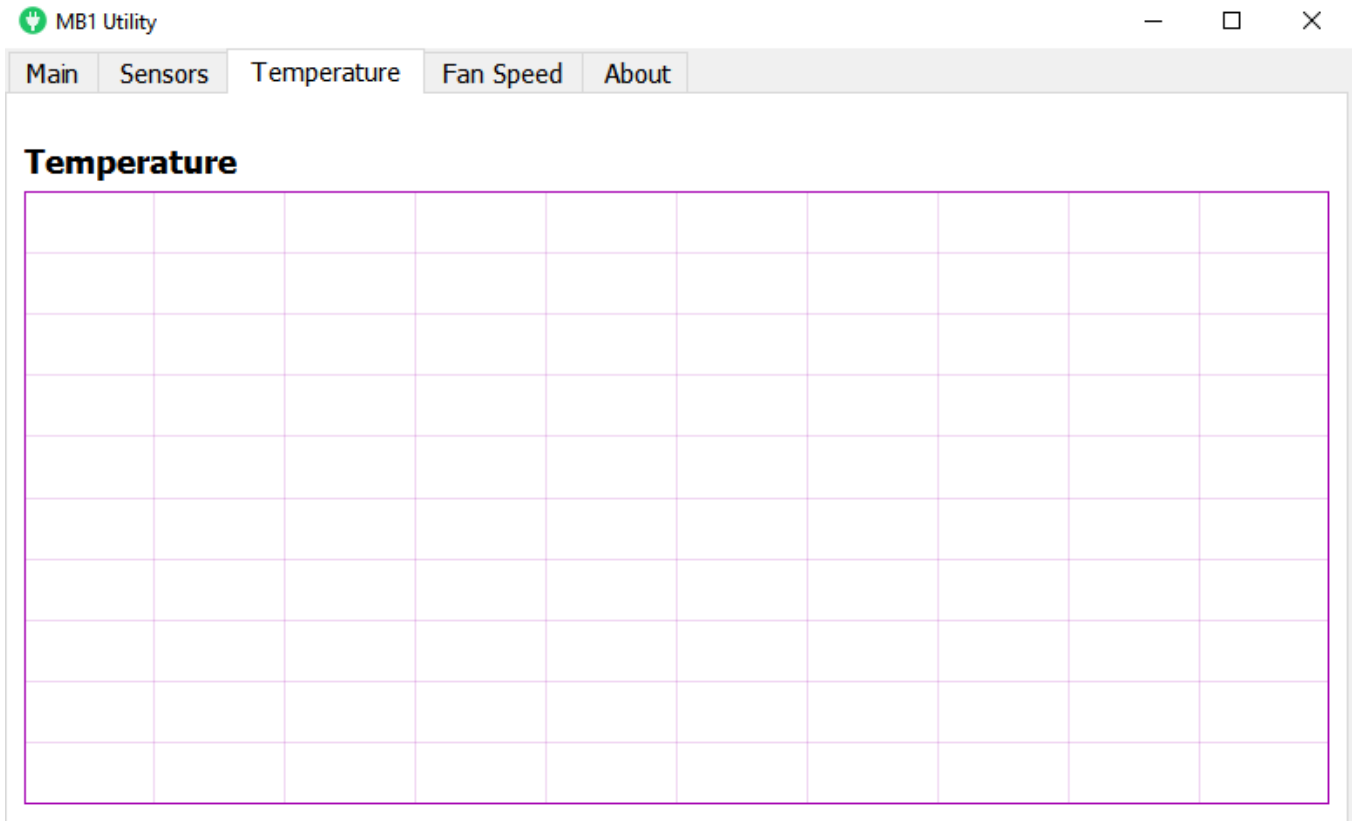

5.13.4 Fan Speed

On the **Fan Speed** tab you can adjust the fan speed settings.

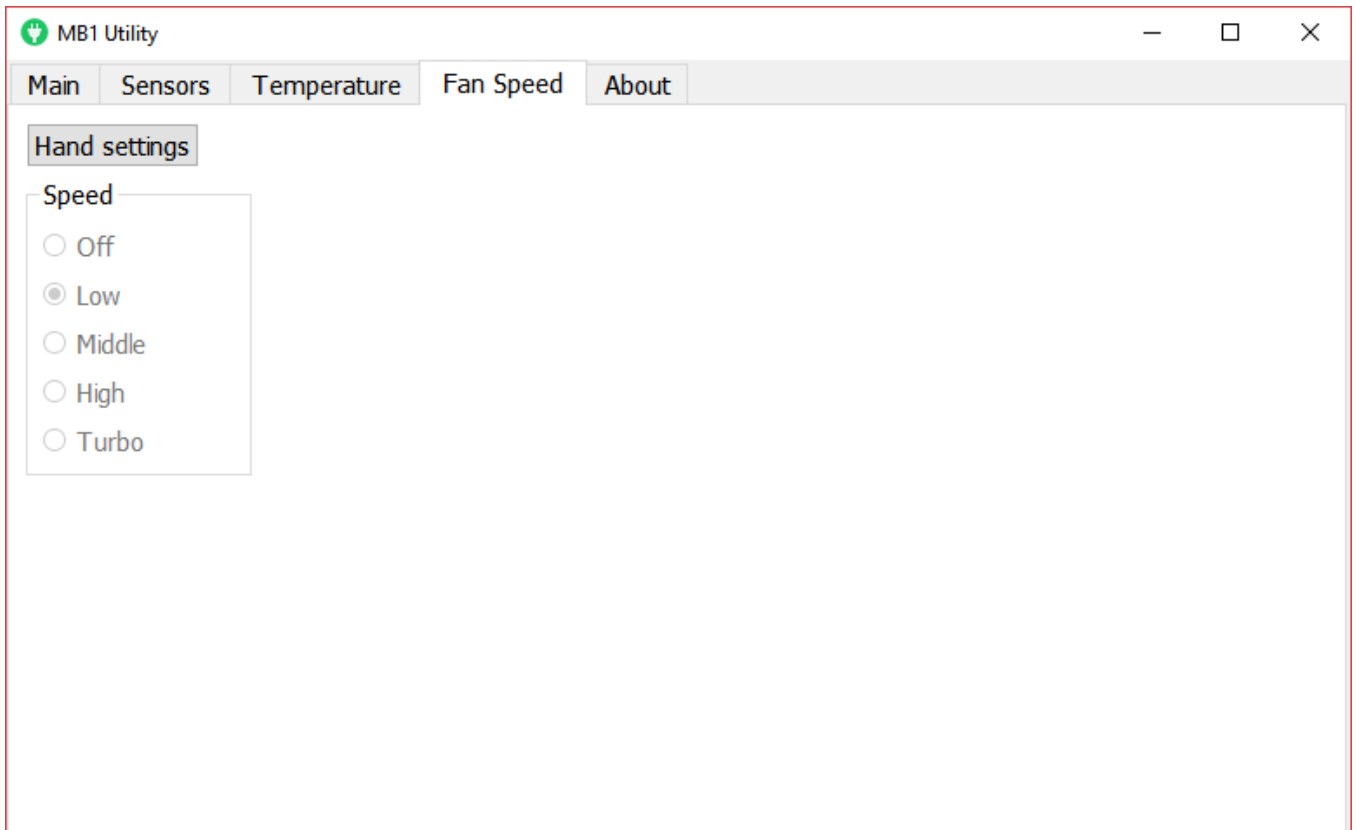

Hand settings - Manual fan control.

Press the **Hand settings** button to enable manual control of the fan speed via presets.

- **Off** - Switch off fan.
- **Low** - Low noise mode.
- **Middle** - Medium fan speed.
- **High** - High fan speed.
- **Typ6o** - Max fan speed.

5.13.5 About

On the **About** tab you can see the info about the name, version of the program, and Copyrights.

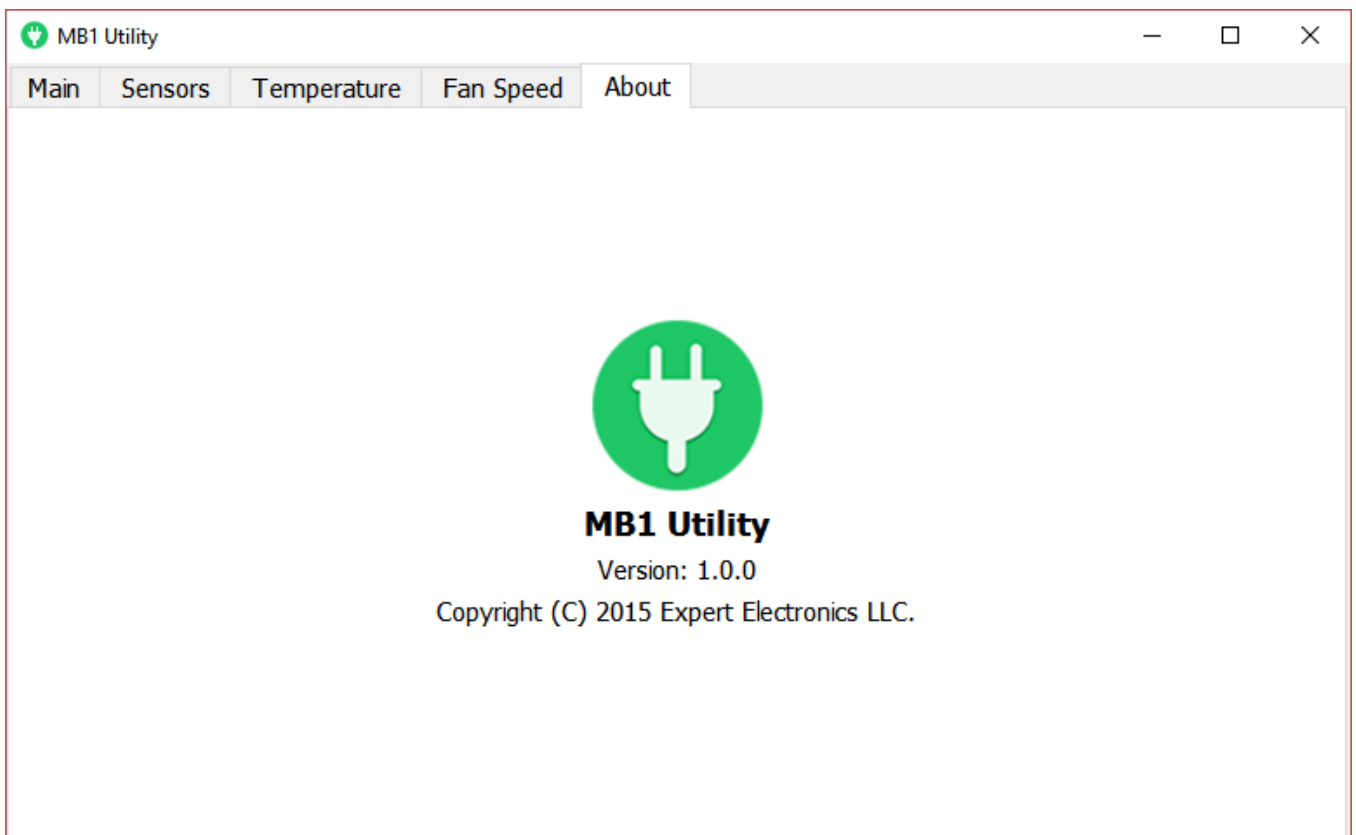

5.14 Windows settings

Make some adjustments in the Windows 10 OS for correct operation of the MB1 transceiver.

Note:

•All required adjustments are made at the manufacturing. Do the adjustments if you reinstalled the Windows 10 OS.

5.14.1 Date and time settings

Do the following to set the date and time:

1. Click the right mouse button on the **time in tray** (marked with a red rectangle on the picture below).
2. Click the left mouse button on the **Adjust date/time** (marked with a red rectangle on the picture below).

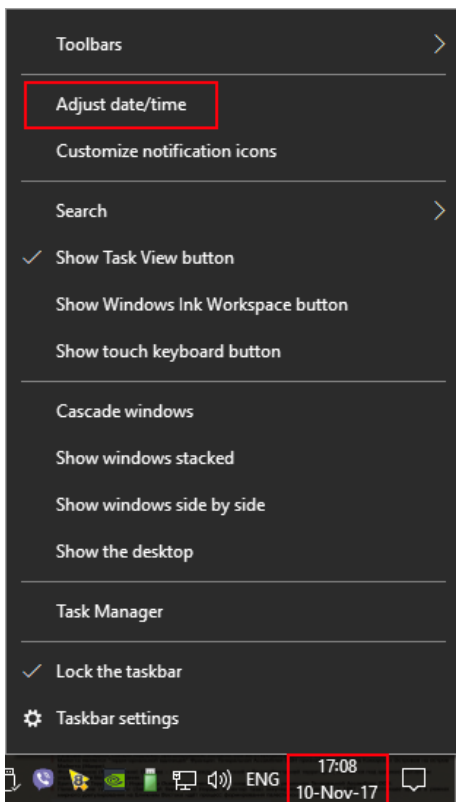

3. Switch off **Set time automatically** (marked with a red rectangle on the picture below).
4. Select your current **Time zone**.
5. Press the **Change** button (marked with a red rectangle on the picture below).

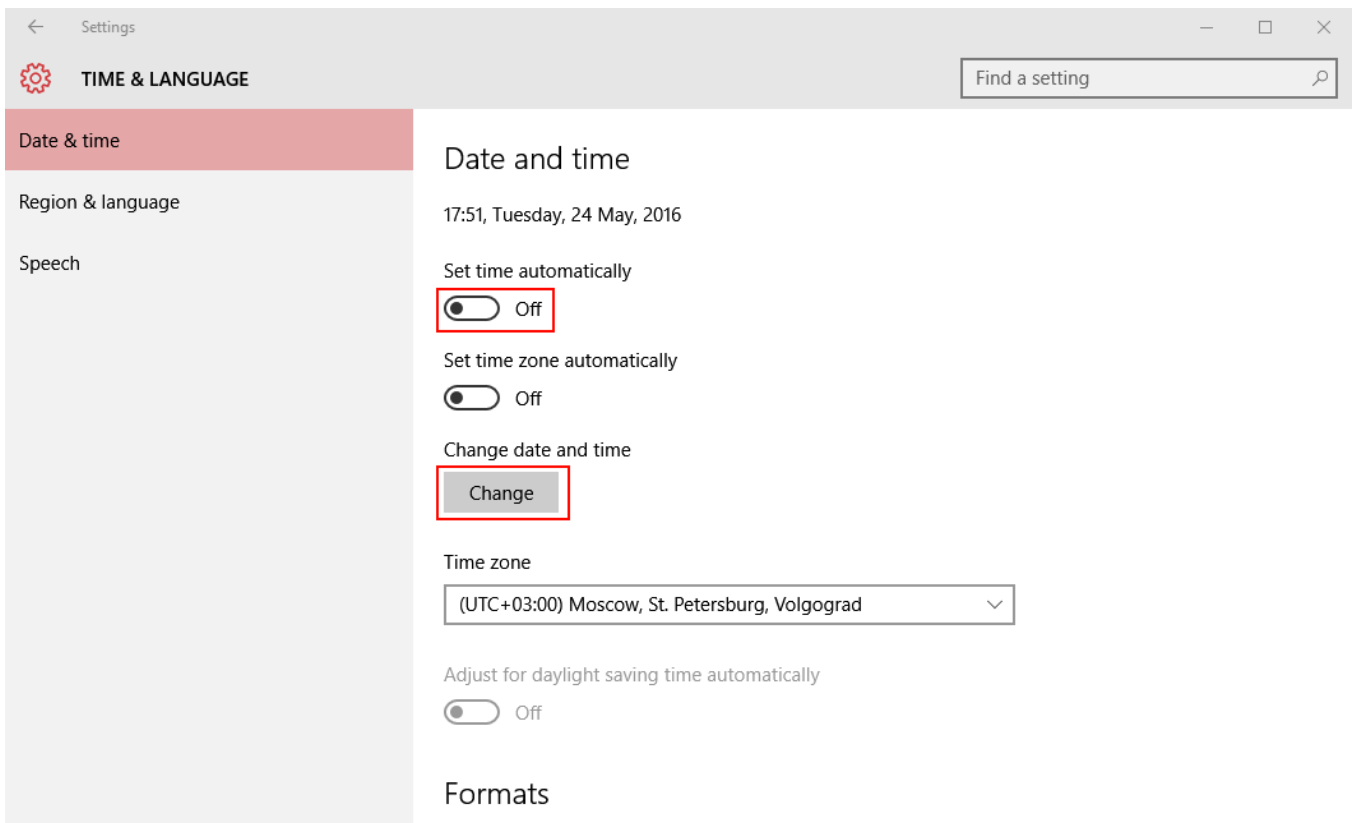

6. In the **Change date and time** menu set current date and time.

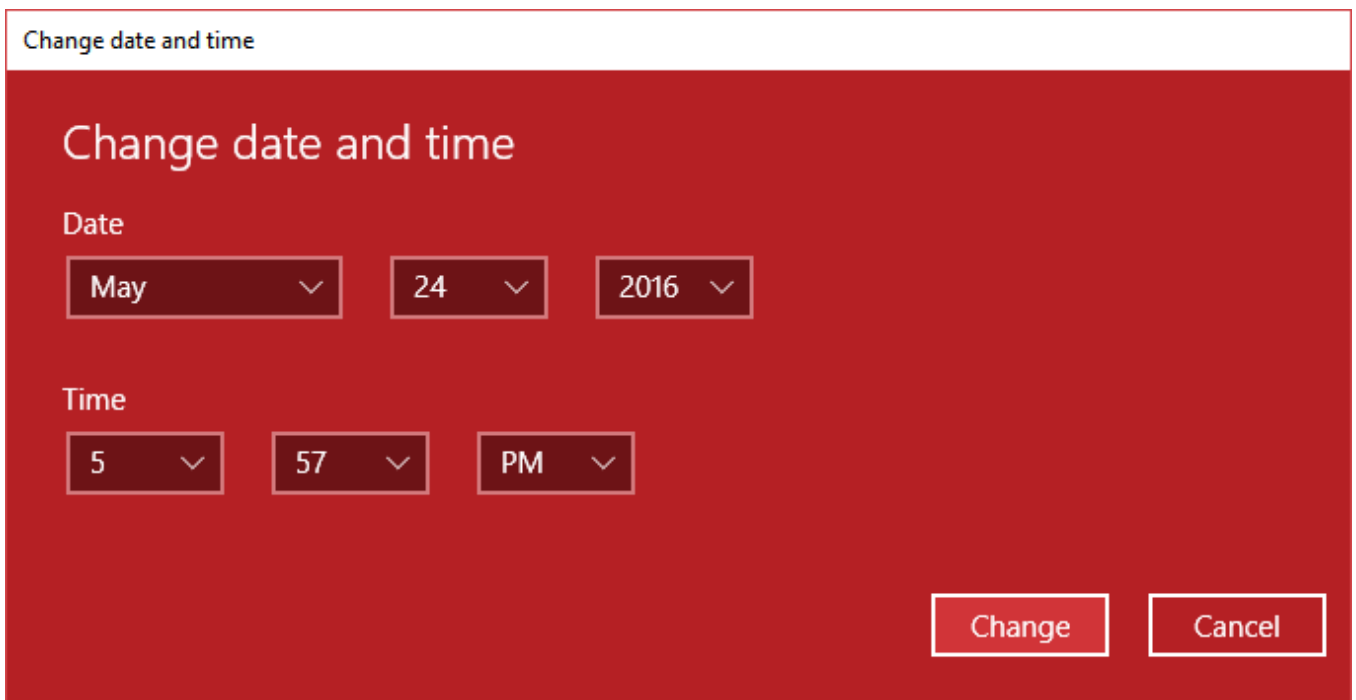

5.14.2 Switch off screen saver

To switch off the screen saver do the following:

1. Click the right mouse button anywhere on the home screen.
2. In the appeared menu select **Personalize**.

3. In the **Personalization** window select **Lock screen** menu-> **Screen saver settings**, by the click of the left mouse button (marked with a red rectangle on the picture below).

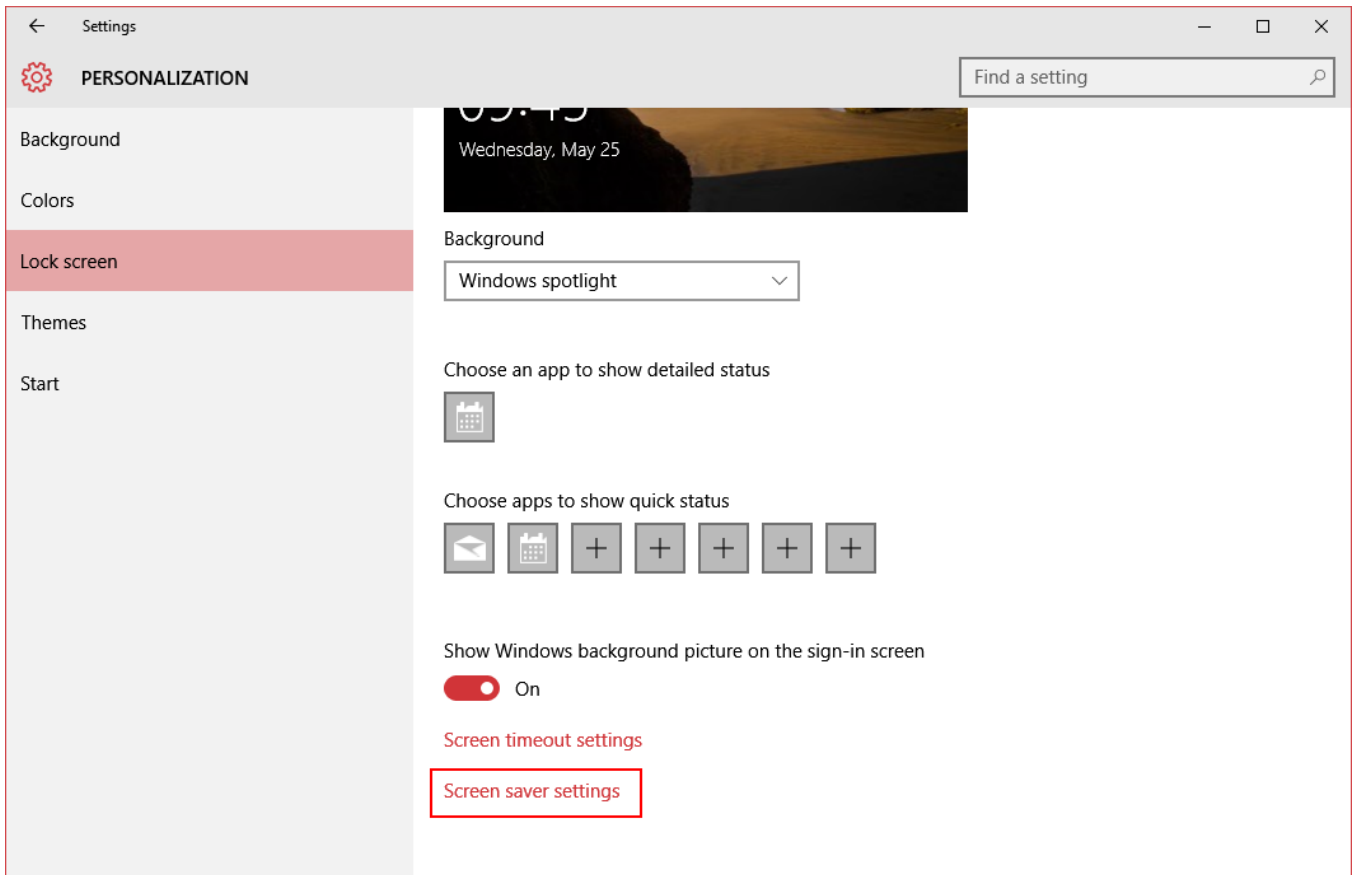

4. In the **Screen saver settings** menu in the **Screen saver** drop-down menu select **(None)**, by the click of the left mouse button (marked with a red rectangle on the picture below).

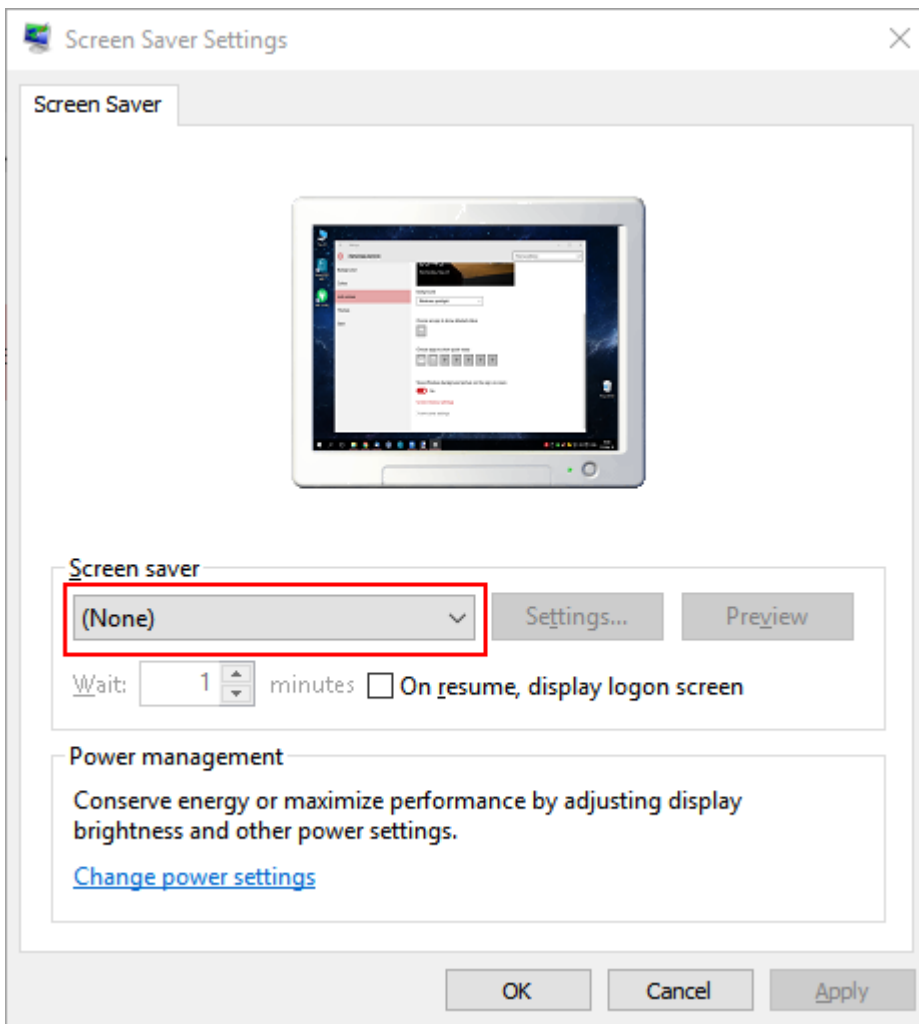
**Note:**

•If your OS was updated, it might change selected (**None**) value to manufacturer settings. Check this out, and switch off the screen saver again, if necessary.

5.14.3 Switch off sleep mode

To switch off the sleep mode do the following:

1. Open the **Start** menu, by pressing the  in the left bottom corner of the screen.
2. Select **Settings** in the menu (marked with a red rectangle on the picture below).



3. In the appeared **Settings** window select the **System** menu by the click of the left mouse button (marked with a red square on the picture below).

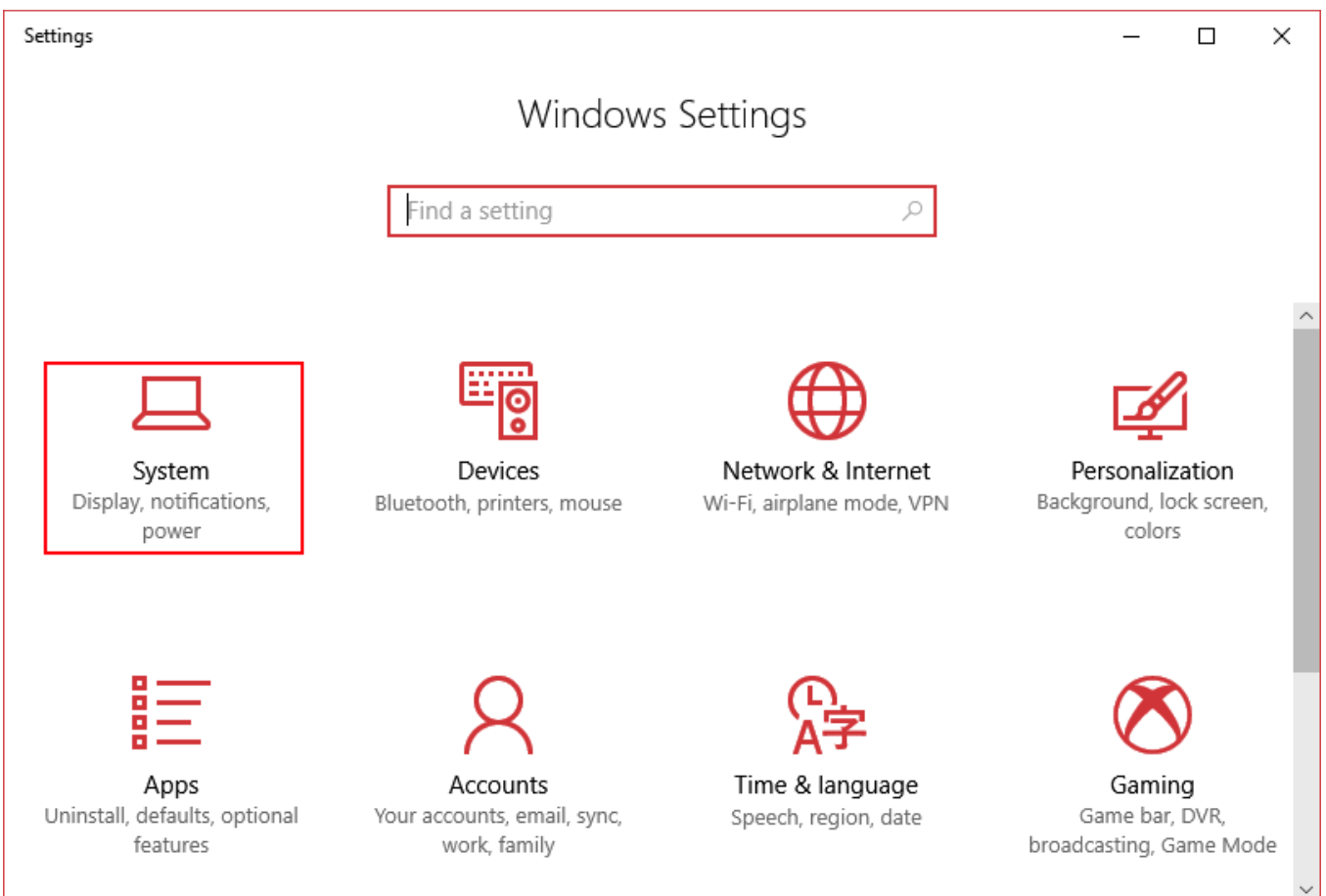

4. In the **System** window select the **Power & sleep** menu by the click of the left mouse button (marked with a red rectangle on the picture below).

5. In the **When plugged in, turn off after** drop-down menu select - **Never**.

6. In the **When plugged in, PC goes to sleep after** drop-down menu select - **Never**.

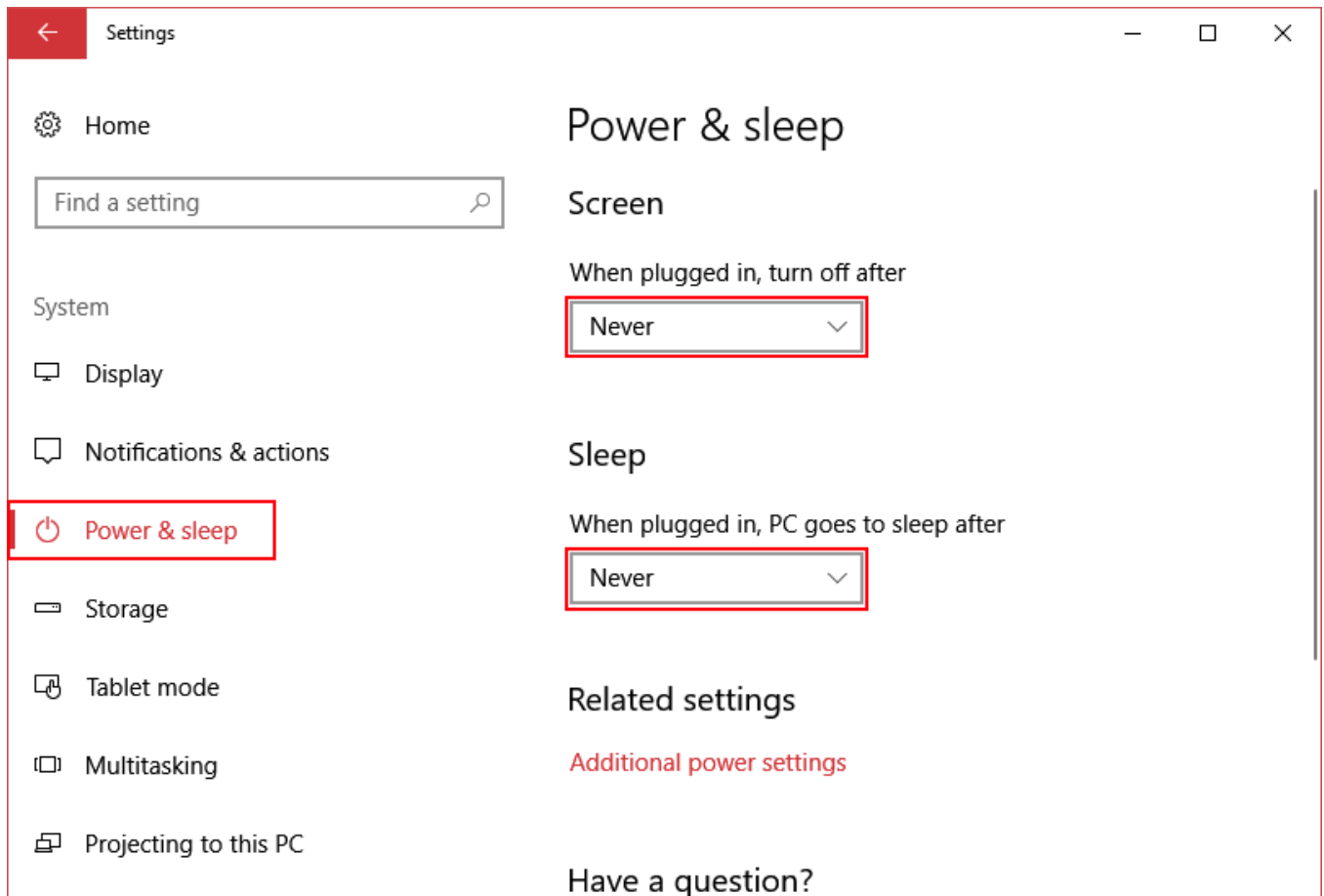

Note:

- If the internal PC went to the sleep mode, after it'll come back transceiver won't function properly. For correct functioning of the transceiver switch it off and then switch on.
- If your OS was updated, it might change selected (**Never**) value to manufacturer settings. Check this out, and switch off the sleep mode again, if necessary.

5.14.4 Network adapter settings

MB1 transceiver has two network adapters. One network adapter is the USB-LAN adapter called MB1 and is used for connection with the SDR-module.

Internal network adapter should be set according to the following steps:

1. Press the Network  sign in tray.
2. In the appeared window click on the **Network settings** menu (marked with a red rectangle on the picture below).

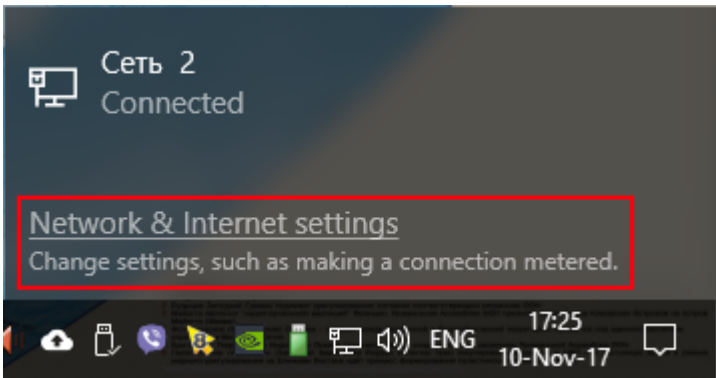

3. In the **Network & Internet** window select **Ethernet-> Change adapter options** (marked with a red rectangle on the picture below).

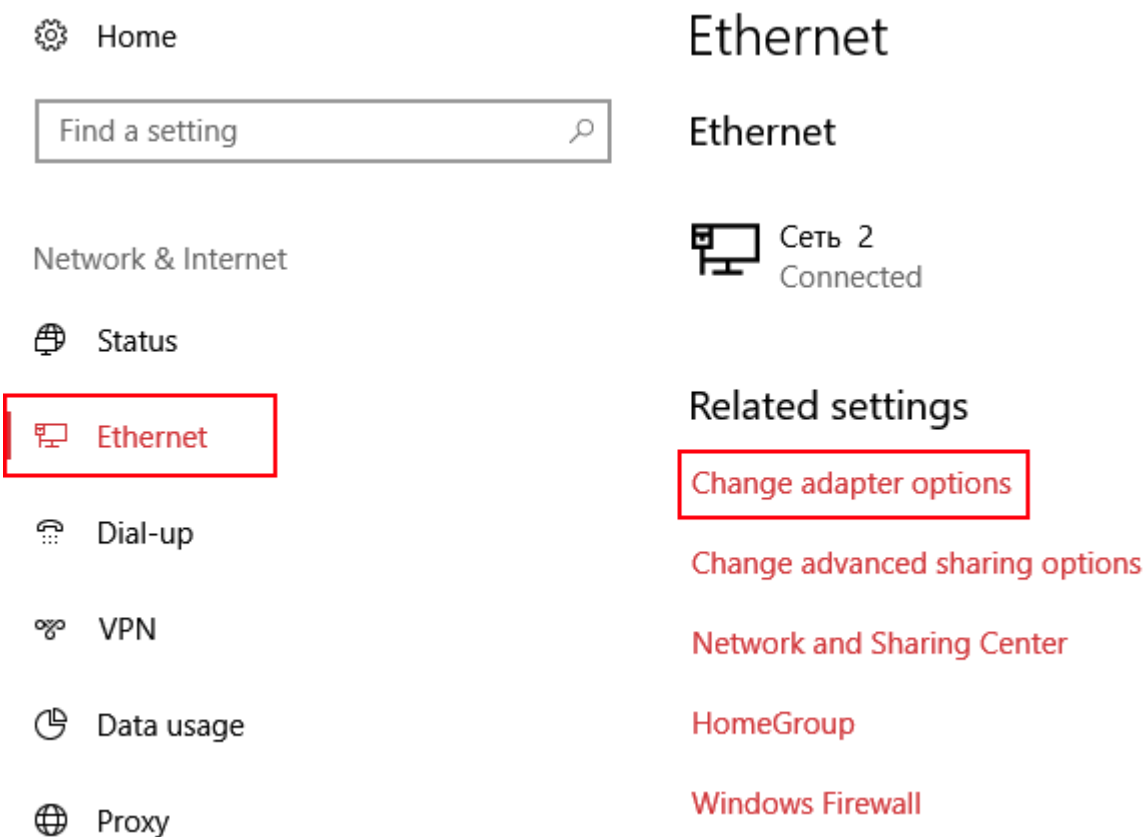

4. In the **Network Connections** window click right mouse button on the **MB1** network icon.

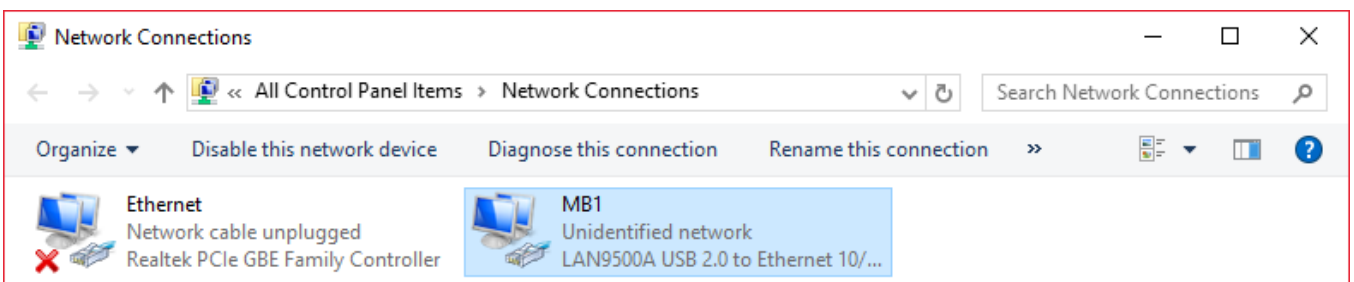

5. In the drop-down menu select **Properties**.

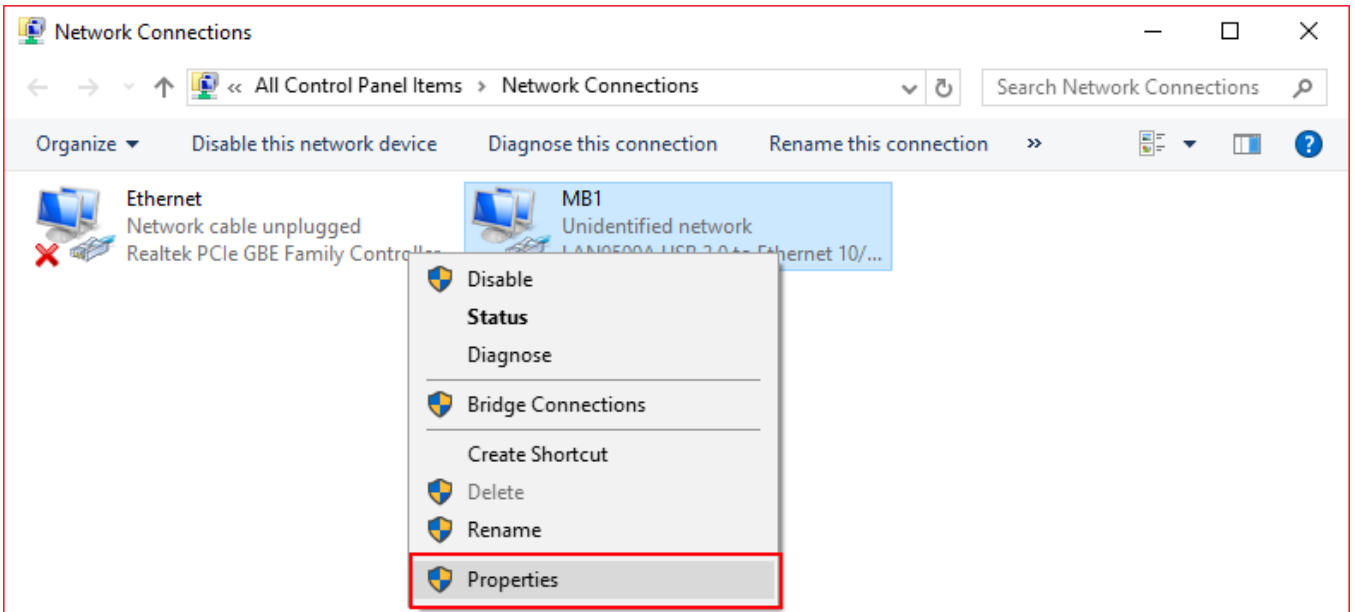

6. In the **MB1 Properties** window select **IP versions 4(TCP/IPv4)** and press **Properties** button.

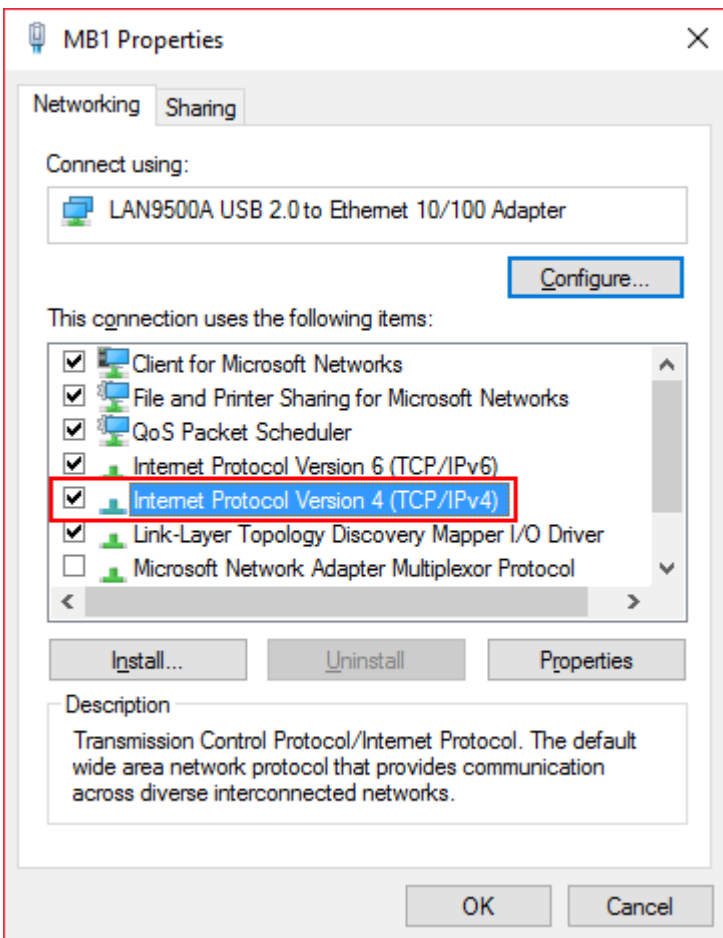

7. In the **IP versions 4(TCP/IPv4) Properties** window set the settings as on the picture below.

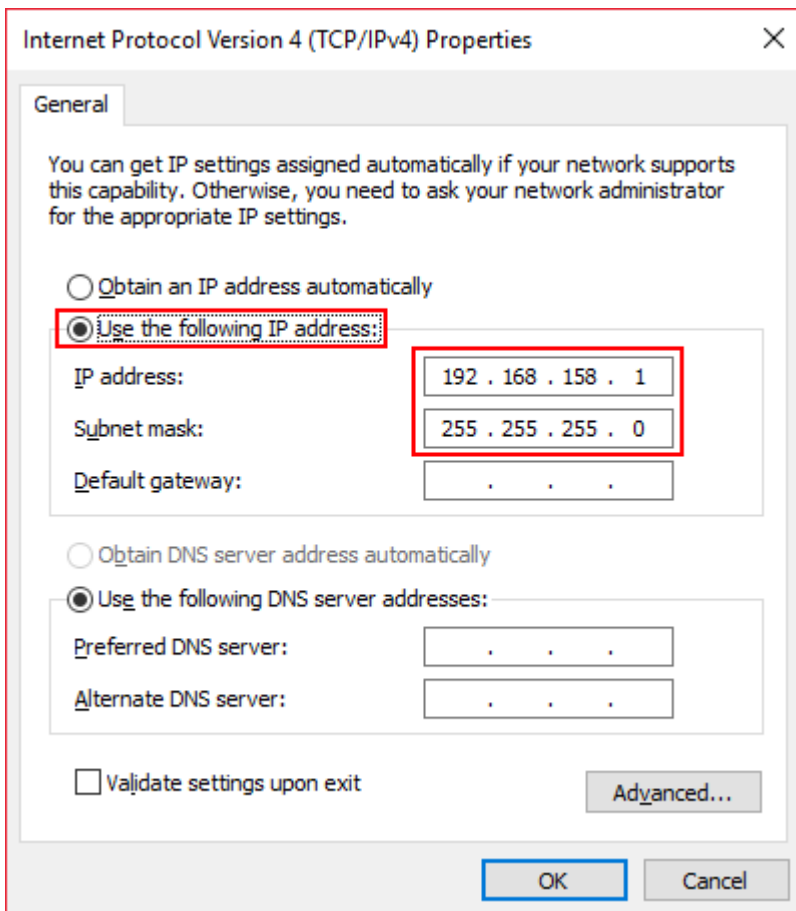

8. Press the **OK** button in this and previous windows.

5.14.5 System recovery

While using the MB1, either your or software actions may result in half or full failure of the device functionality.

To protect your device from it, we recommend to create **system restore points** from time to time, which could be used in case of Windows OS failure.

5.14.5.1 Create restore point

To create the restore point do the following:

1. Open the **Start** menu, by pressing the  in the left bottom corner of the screen.
2. Select **Settings** in the menu (marked with a red rectangle on the picture below).



3. In the appeared **Settings** window select the **System** menu by the click of the left mouse button (marked with a red square on the picture below).

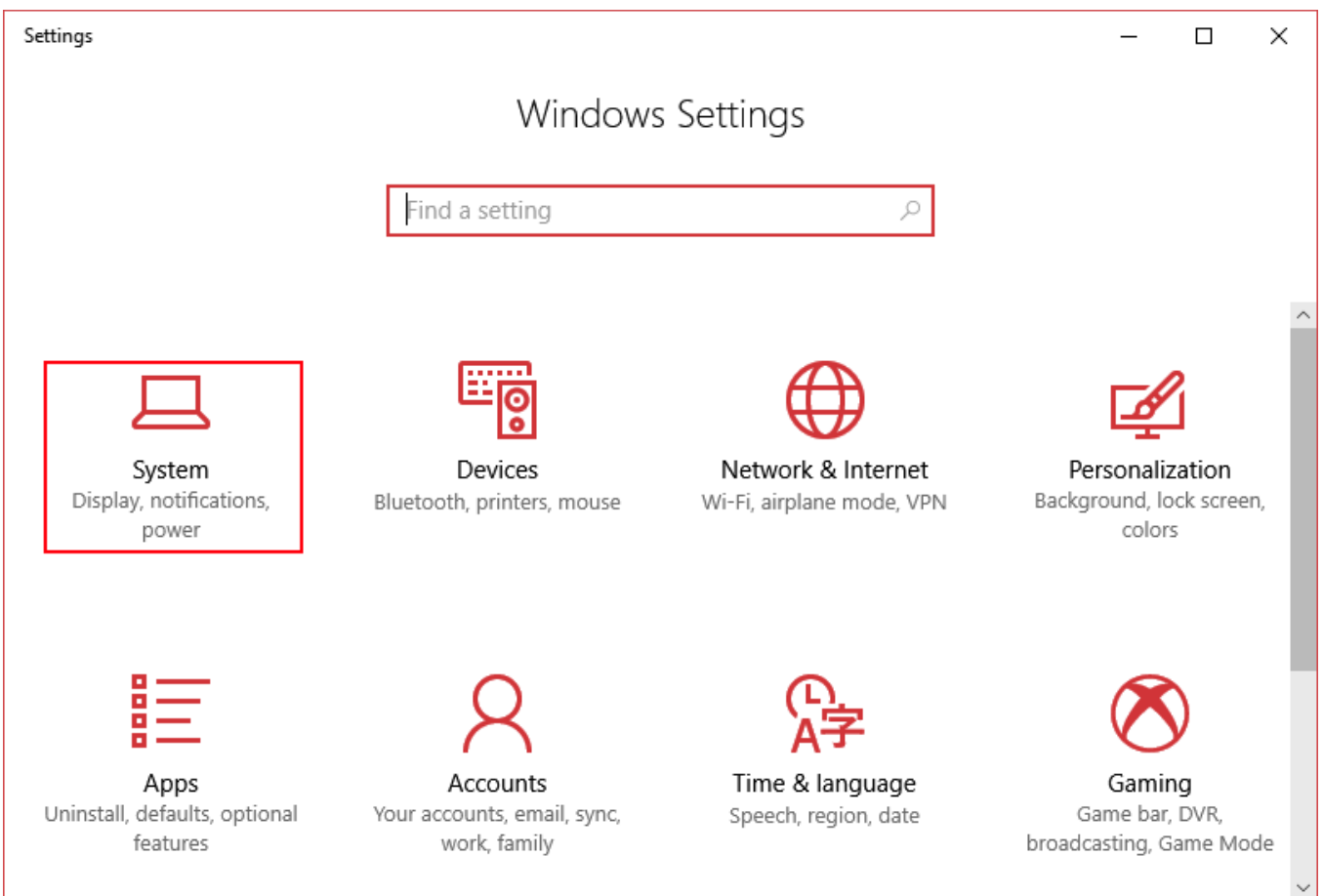

4. In the **System** window select the **About** menu, then select **System info** by the click of the left mouse button (marked with a red rectangle on the picture below).

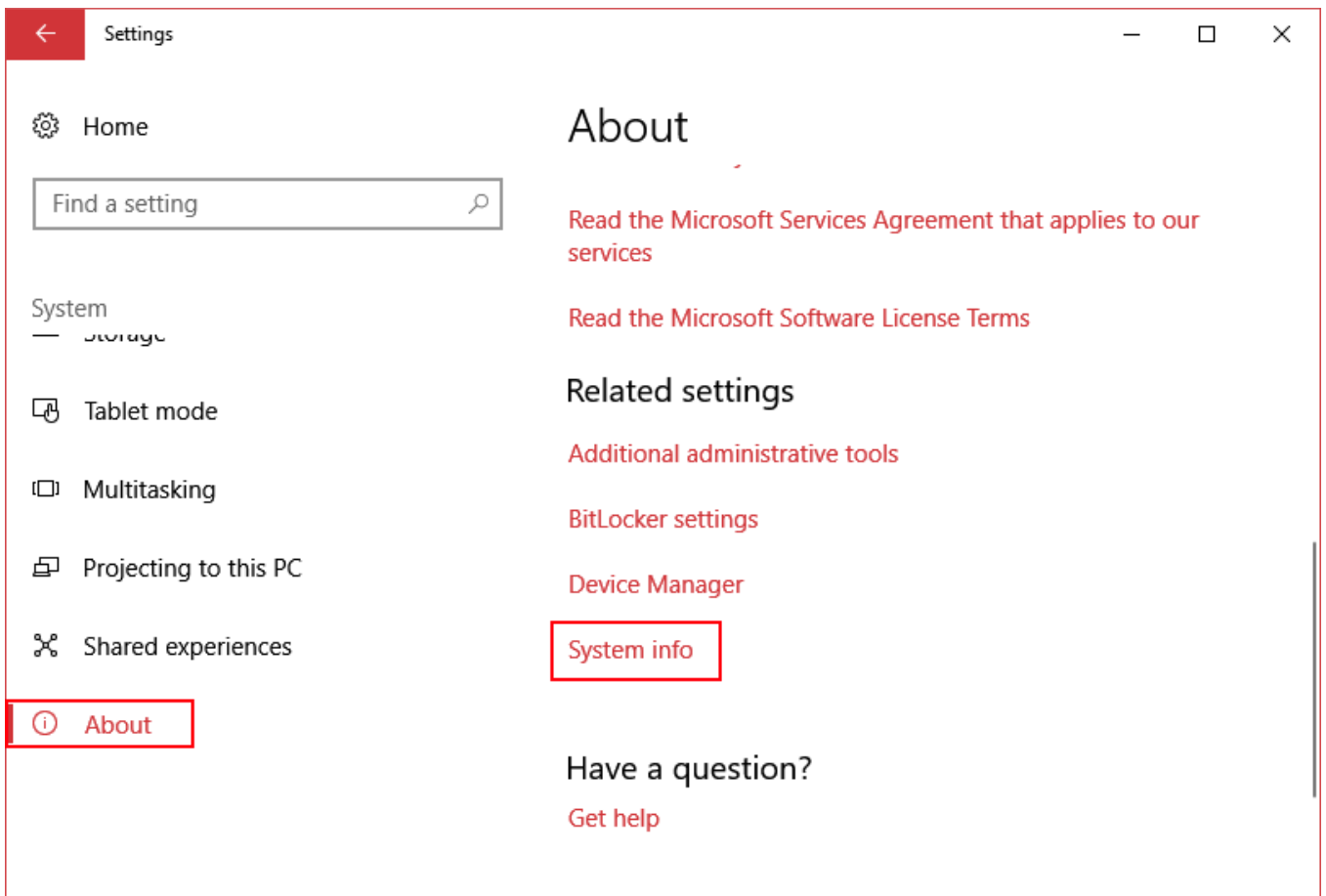

5. In the **System** window select the **Advanced system settings**.

The screenshot shows the Windows System control panel window. The left sidebar contains links to various system settings, with 'Advanced system settings' highlighted by a red box. The main content area provides a comprehensive overview of the system's configuration and hardware details.

System

Control Panel Home

View basic information about your computer

Windows edition

Windows 10 Home

© 2015 Microsoft Corporation. All rights reserved.

System

Processor: Intel(R) Core(TM) i5-4590T CPU @ 2.00GHz 2.00 GHz

Installed memory (RAM): 8.00 GB (7.87 GB usable)

System type: 64-bit Operating System, x64-based processor

Pen and Touch: Touch Support with 10 Touch Points

Computer name, domain, and workgroup settings

Computer name: DESKTOP-1OEREL7 [Change settings](#)

Full computer name: DESKTOP-1OEREL7

Computer description:

Workgroup: WORKGROUP

Windows activation

Windows is activated [Read the Microsoft Software License Terms](#)

Product ID: 00326-10855-35165-AA438 [Change product key](#)

See also

Security and Maintenance

6. In the **System Properties** window select the **System Protection** tab.

7. Select the Local Disk (**C:**) and press the **Configure** button.

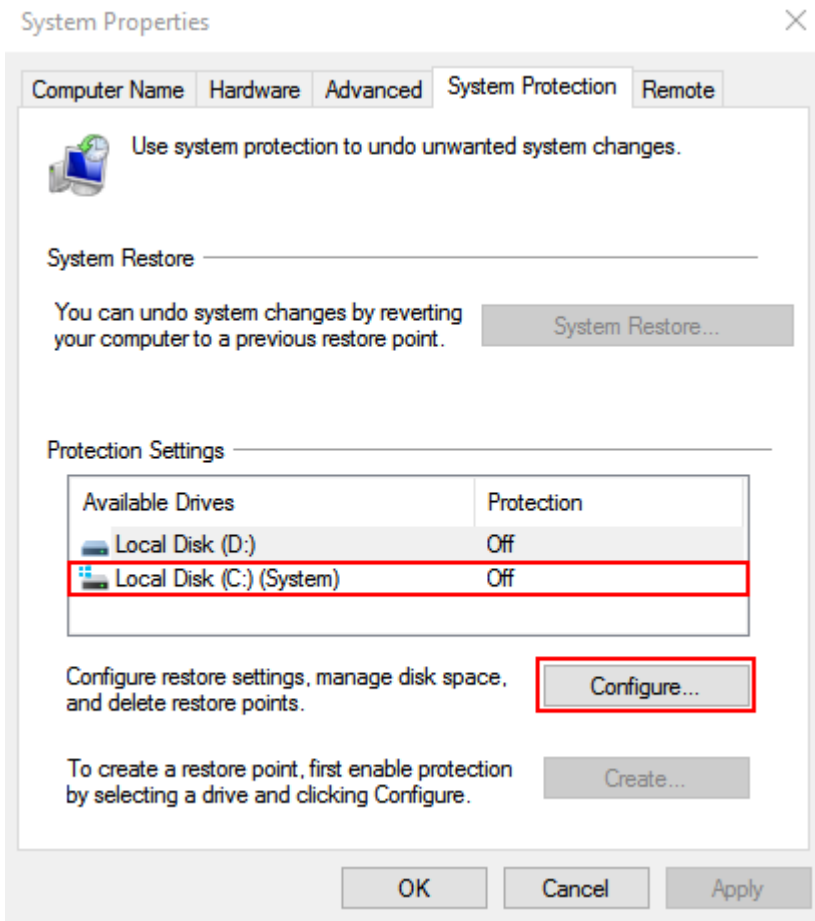

8. In the **System Protection for Local Disk (C:)** window set the **Turn on system protection** and with the slider set the Max Usage for this purposes - it is recommended to use 5...10 % of the disk (see the picture below).

9. Press **Apply** then **OK**, the window will be closed.

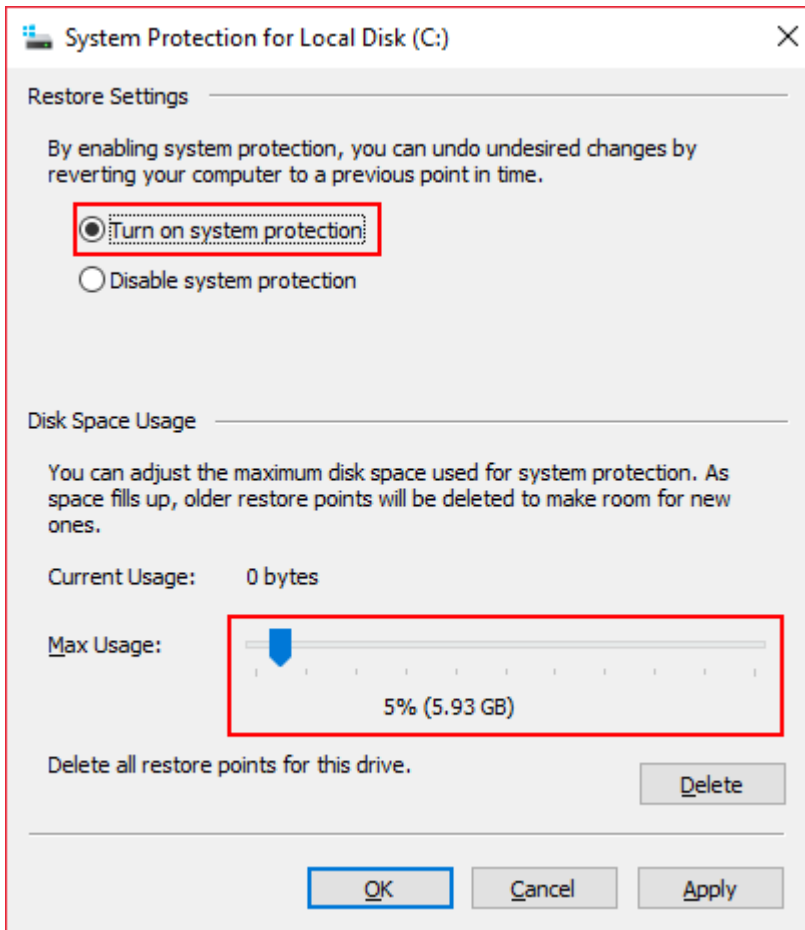

10. In the **System Properties** window press **Create** button (marked with a red rectangle on the picture below).

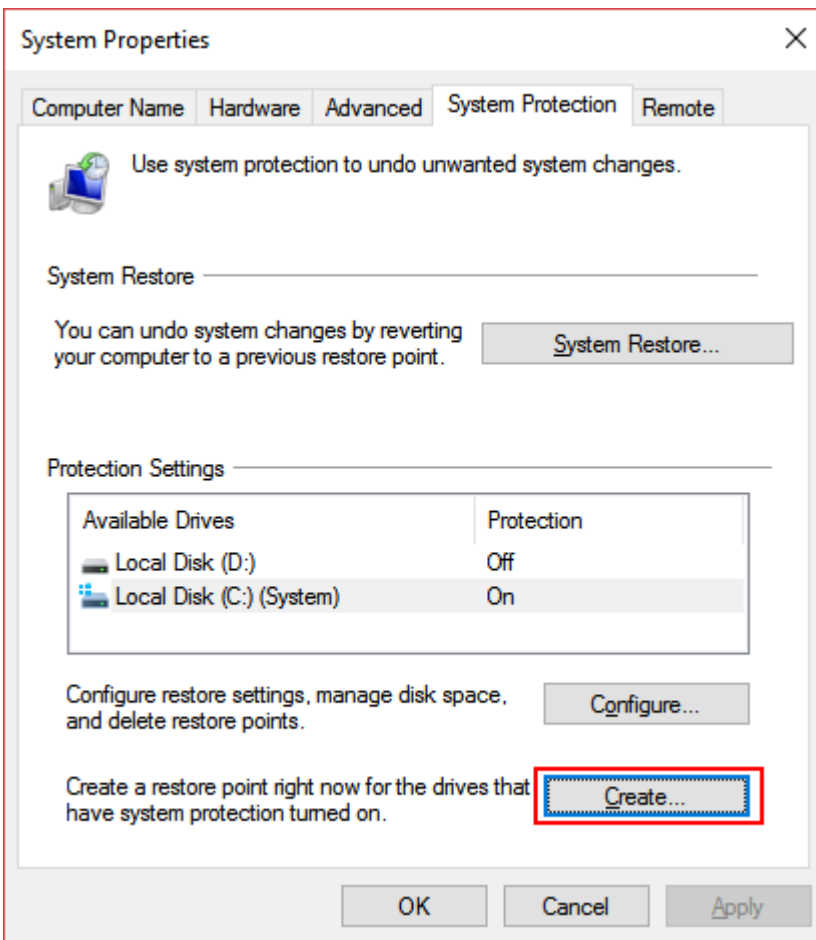

11. In the **System Protection** window enter the name of the restore point, then press the **Create** button.

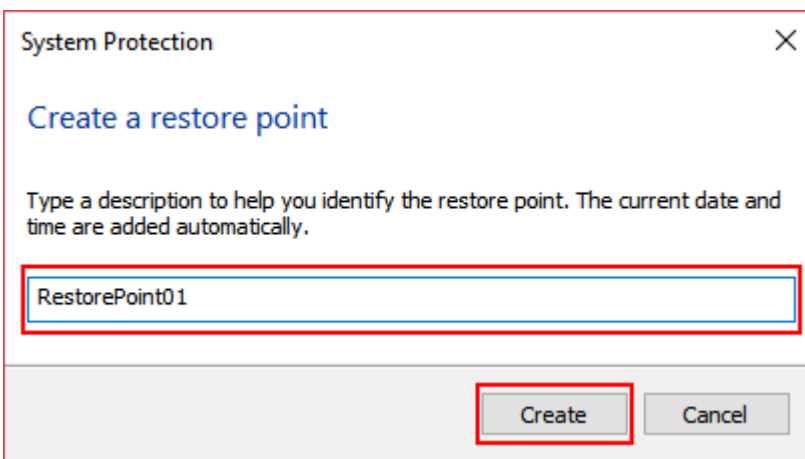

12. You've created the restore point, the window will be closed automatically.

5.14.5.2 Use restore point

To **restore the system** from the previously created **restore point** do the following:

1. Open the **Start** menu, by pressing the  in the left bottom corner of the screen.

2. Select **Settings** in the menu (marked with a red rectangle on the picture below).



3. In the appeared **Settings** window select the **System** menu by the click of the left mouse button (marked with a red square on the picture below).

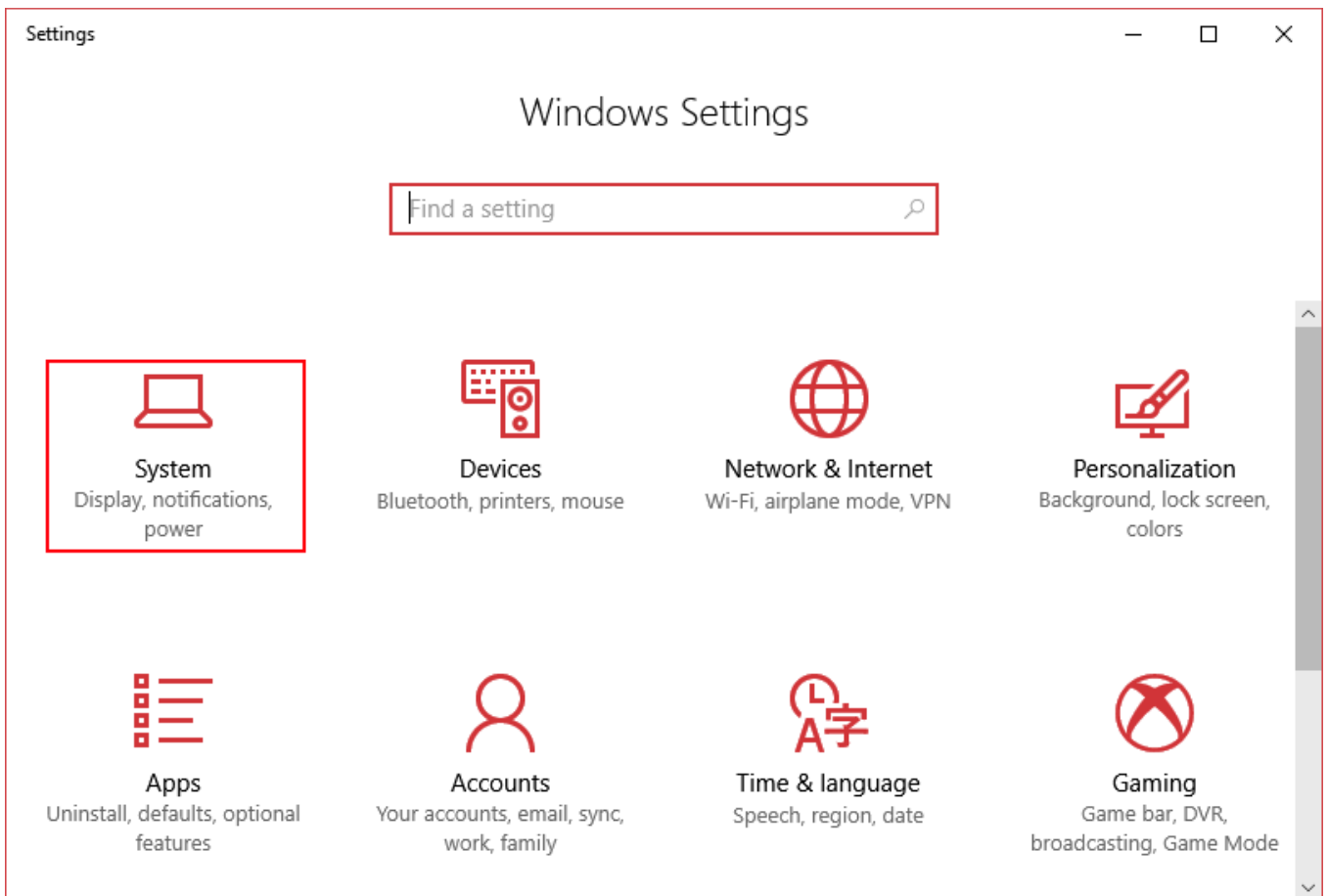

4. In the **System** window select the **About** menu by the click of the left mouse button (marked with a red rectangle on the picture below).

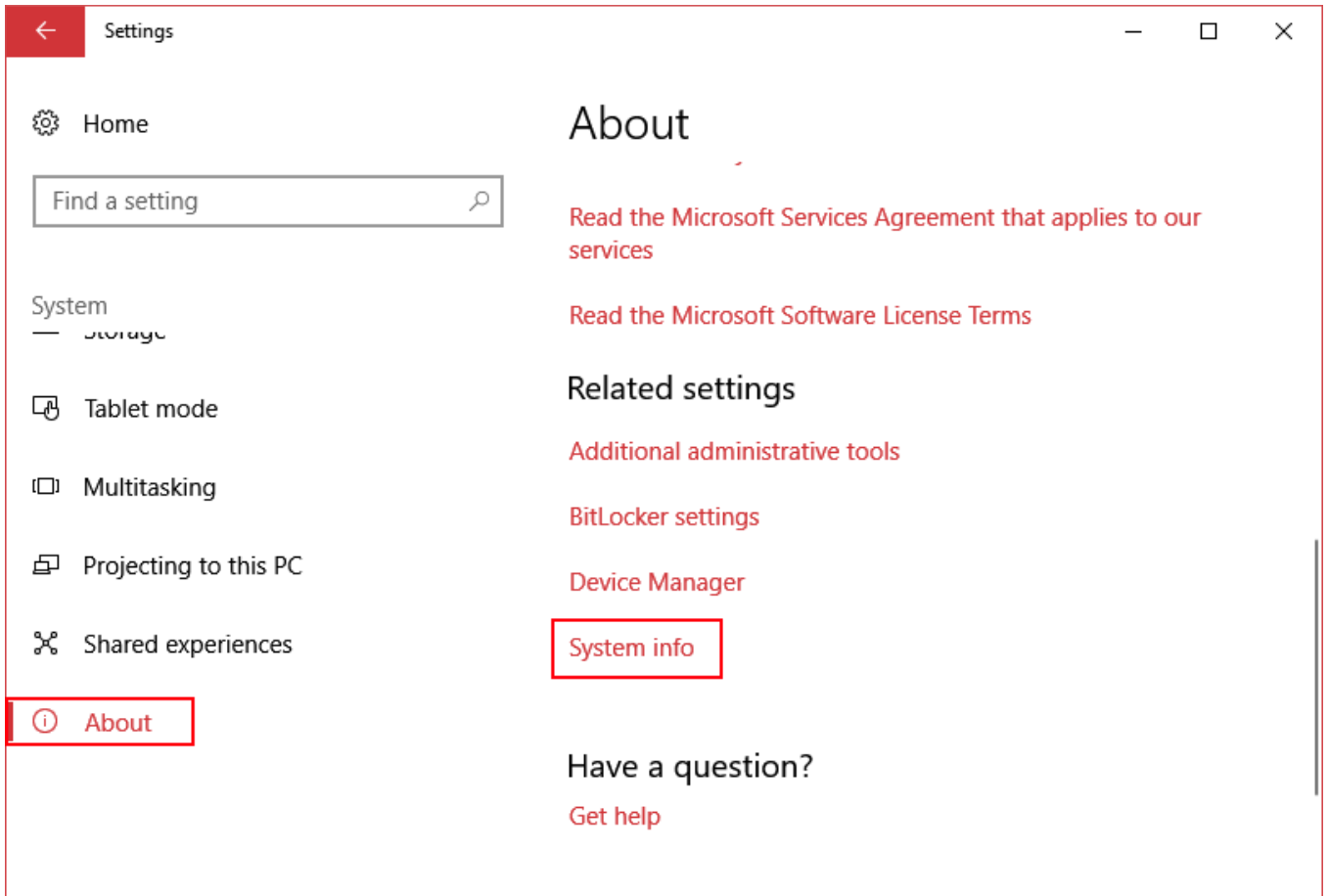

5. In the **System** window select the **Advanced system settings**.

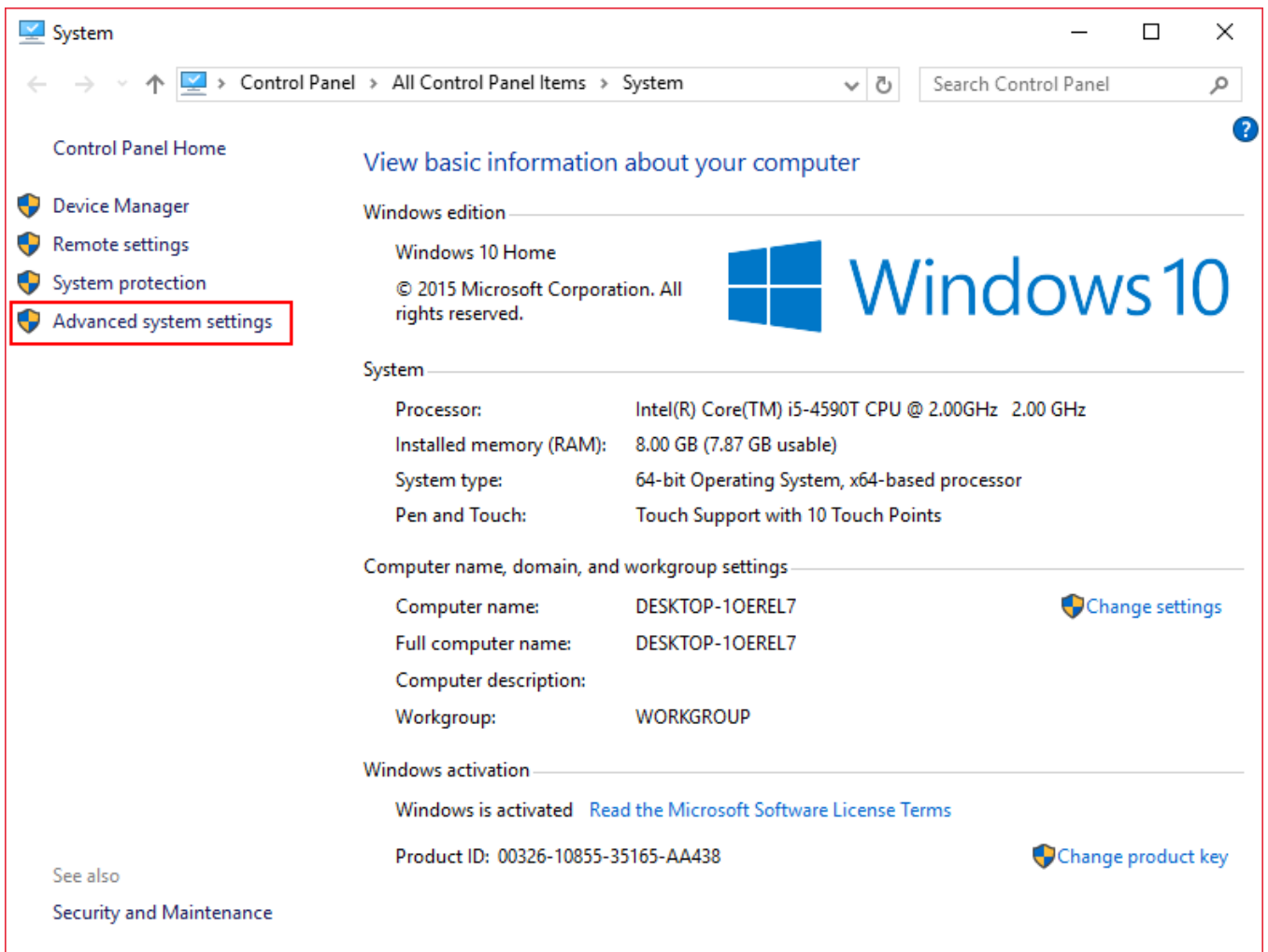

6. In the **System Properties** window select the **System Protection** tab.

7. Press the **System Restore...** button to launch the restore process.

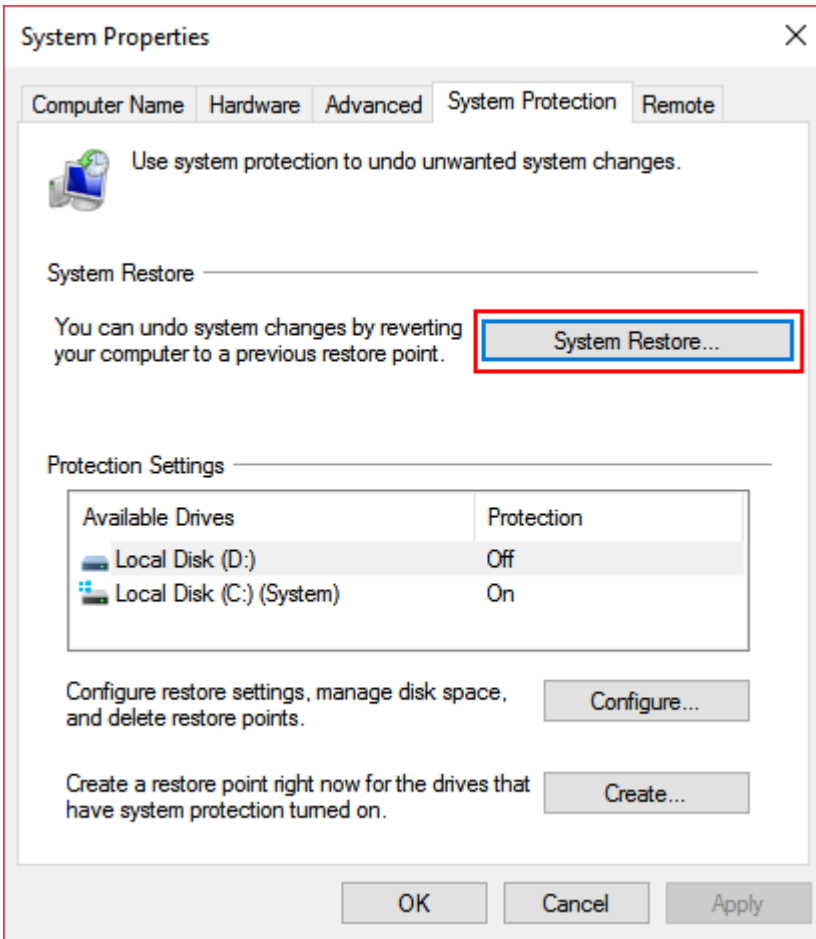

8. In the **System Restore** window press the **Next** button.

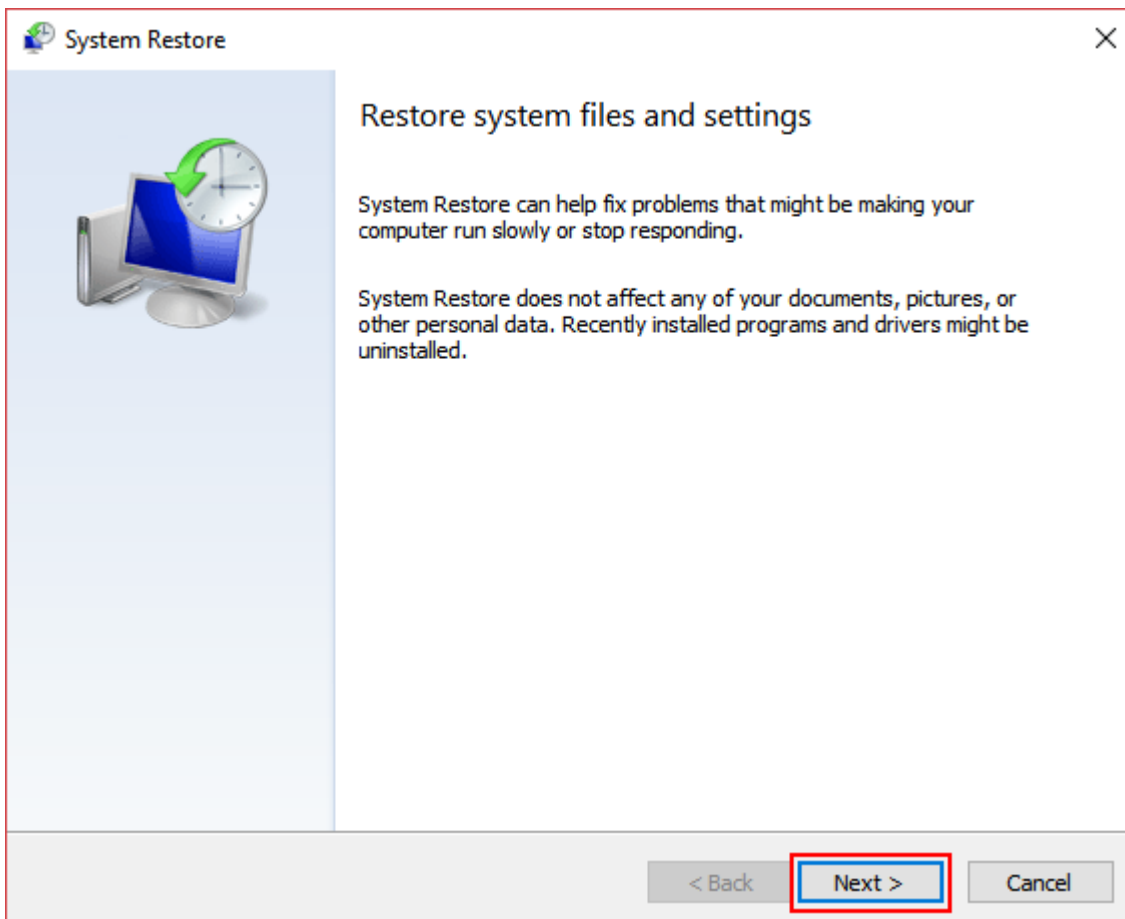

9. On the next step select previously created Restore Point from the list and press the **Next** button.

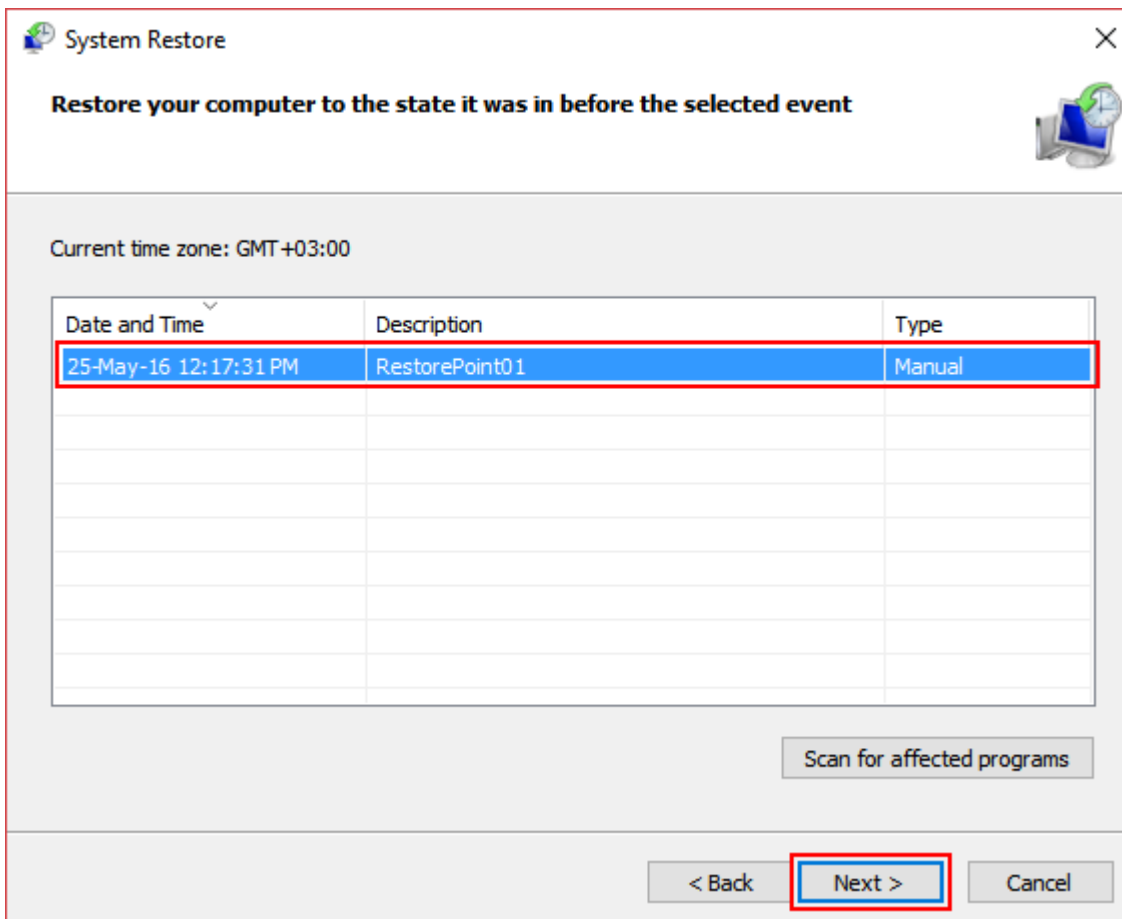

10. Confirm your restore point by pressing the **Finish** button.

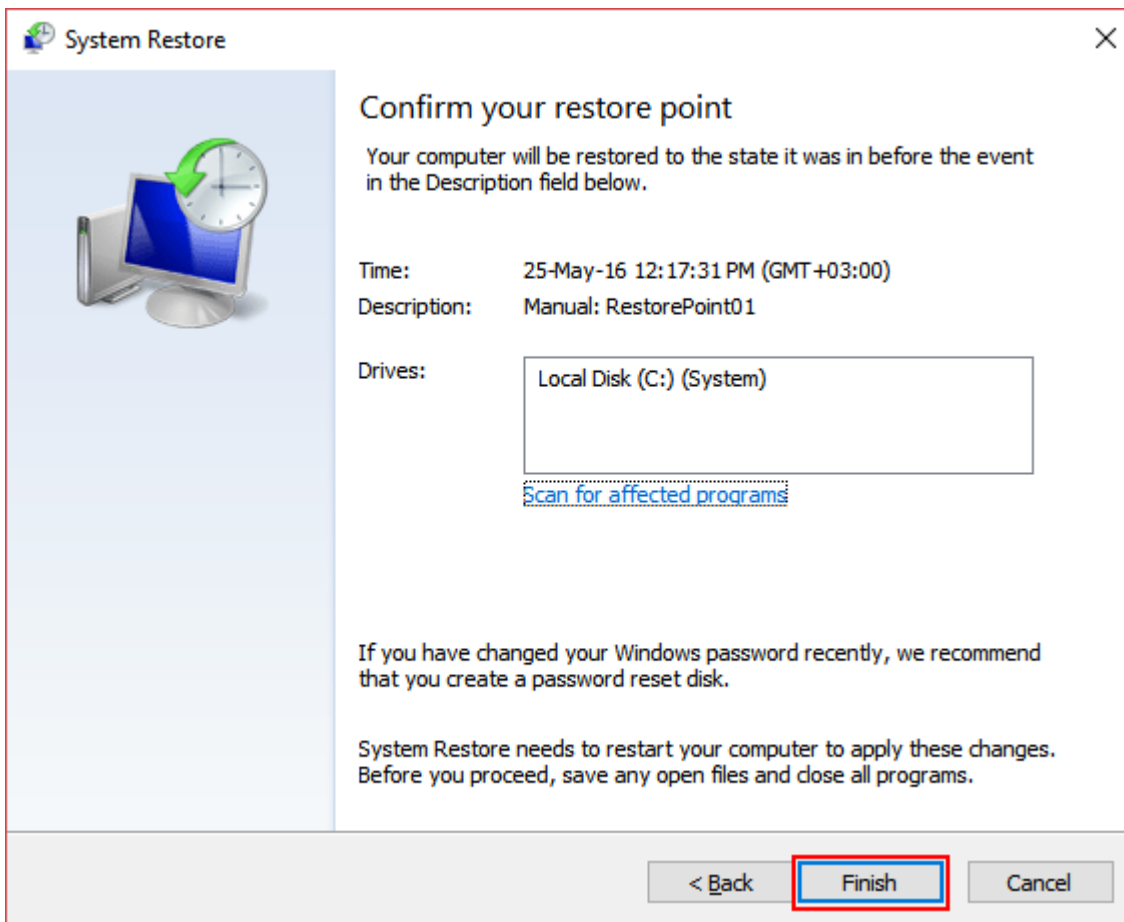

Note:

- You still can refuse to restore the system on this step, by pressing the **Cancel** button.
- You still can refuse to restore the system from the selected restore point and change it to another one by pressing the **<Back** button.

11. Windows will inform about successful system recovery. Press the **Close** button.

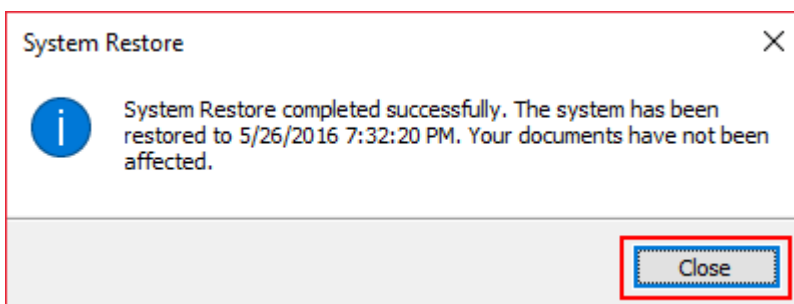

5.14.6 Windows password

You need to disable Windows password for automatic start of the MB1 transceiver by pressing the power button.

Note:

- Windows password is disabled by default.

5.14.6.1 Enable Windows password

To enable the Windows password for your account, do the following:

1. Click the left/right mouse button on your account name in the **Start** menu and select **Change account settings**.

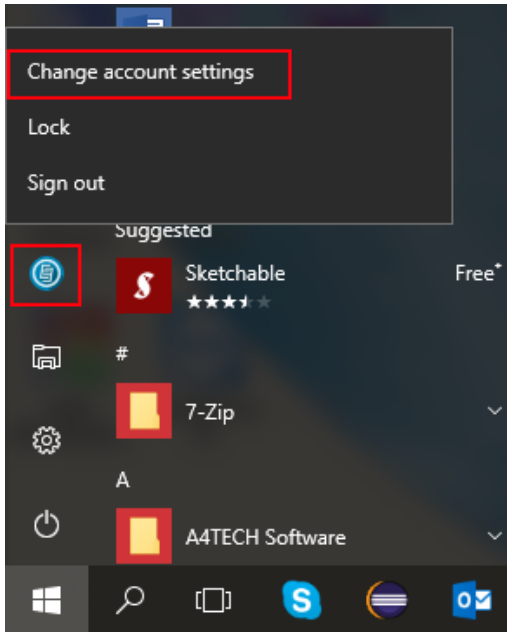

2. In the **Accounts** window select **Sign-in options** menu.
Press the **Add** button and follow the instructions.

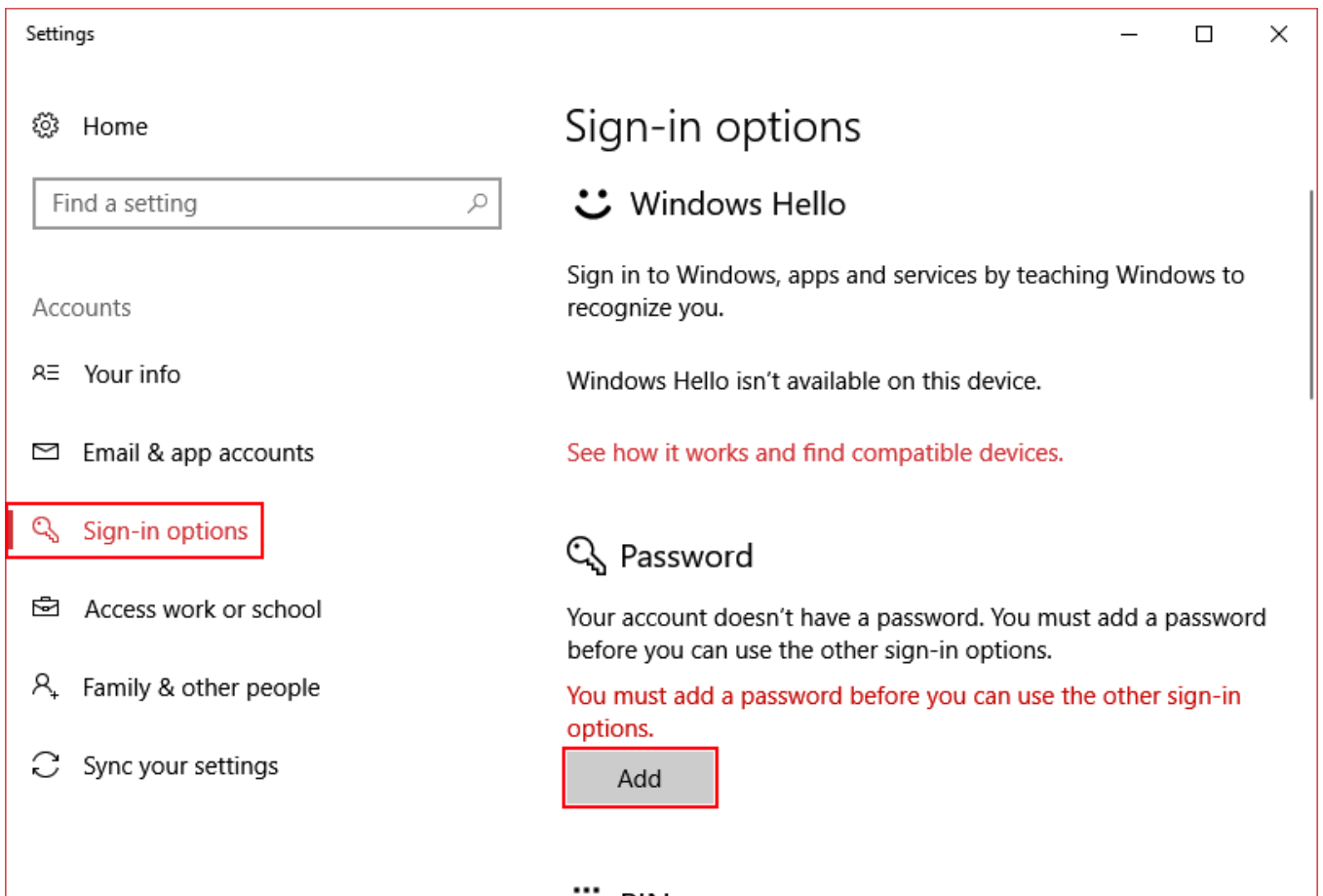

Note:

•Now Windows will require the password each time you launch the transceiver.

5.14.6.2 Disable Windows password

To disable the Windows password for your account, do the following:

1. Click the left/right mouse button on your account name in the **Start** menu and select **Change account settings**.

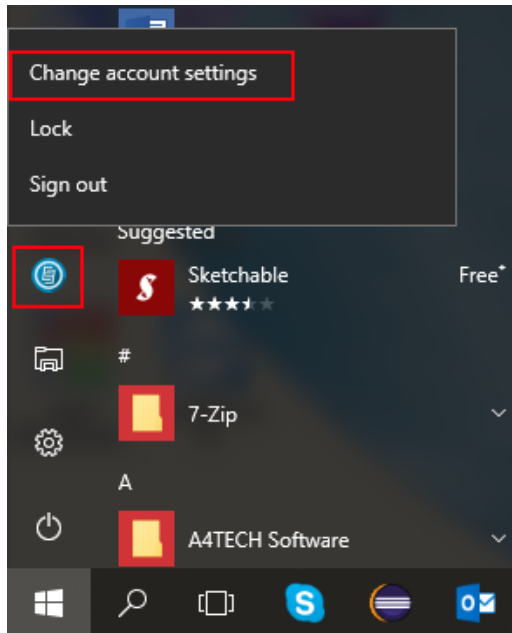

2. In the **Accounts** window select **Sign-in options** menu.
3. Press the **Change** button.

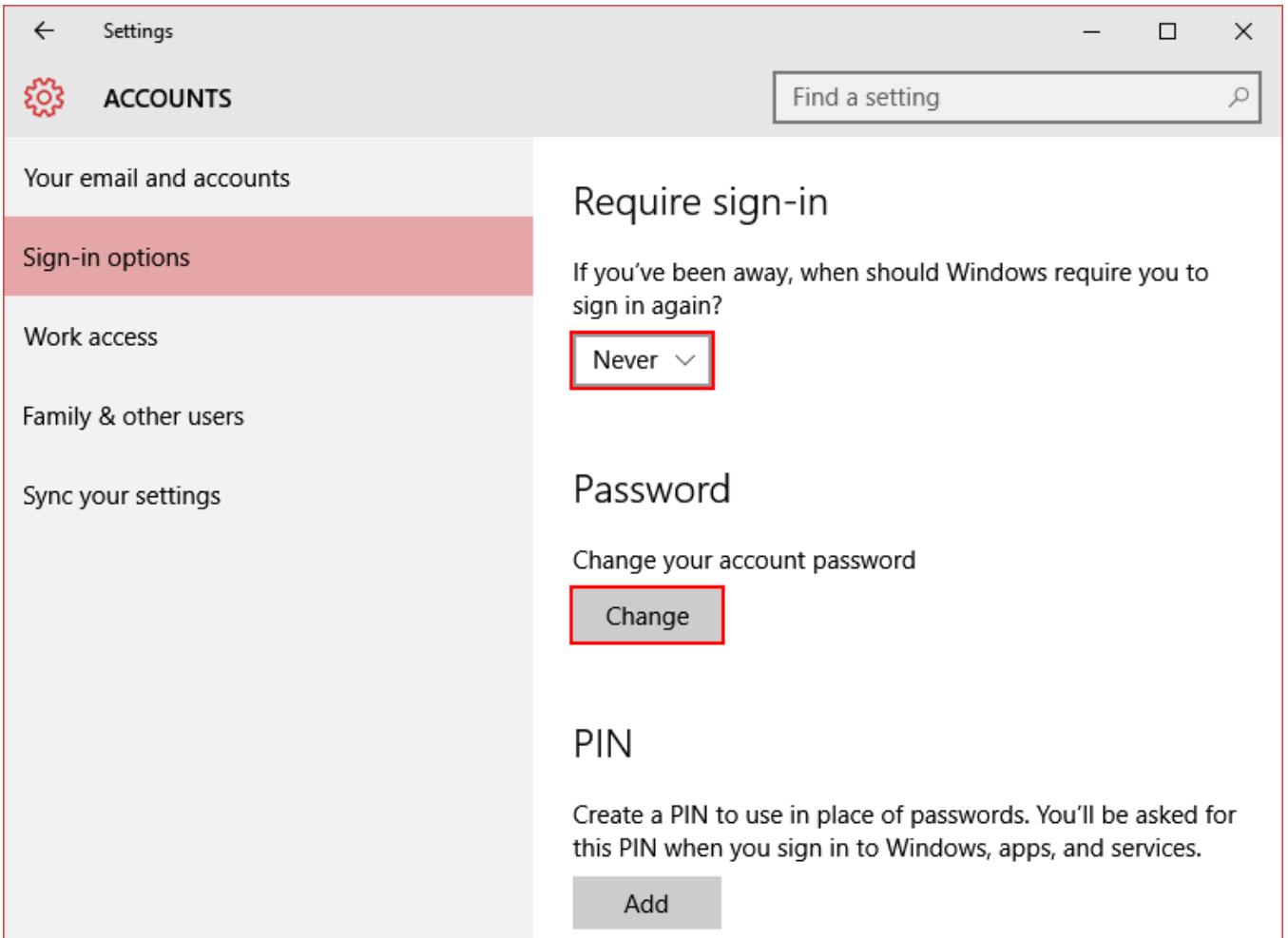

5. In the **Change your password** window enter your current password and press the **Next** button.

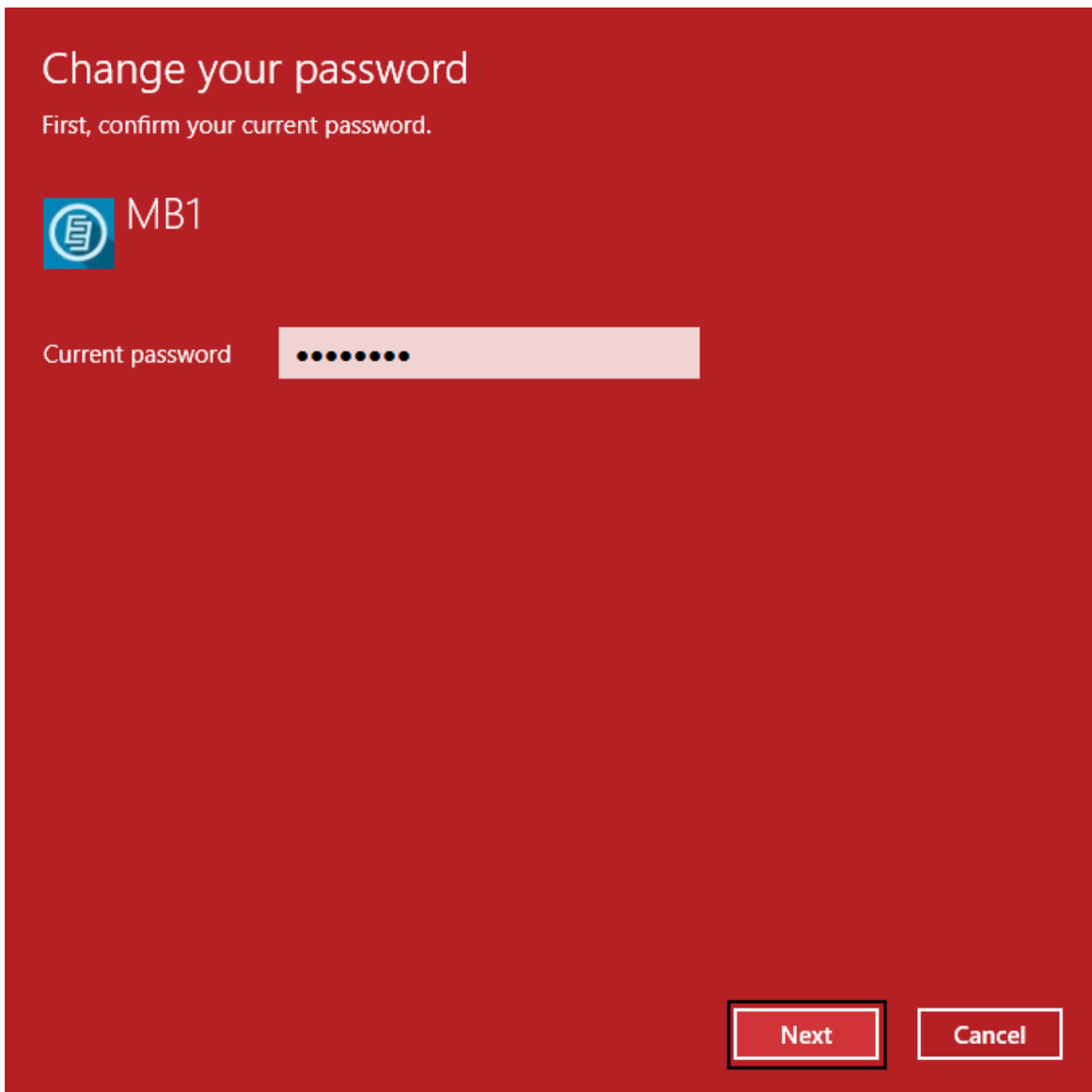

Change your password

First, confirm your current password.

 MB1

Current password

Next Cancel

6. In the next **Change your password** window left **New password** and **Reenter password** fields blank, press the **Next** button, the window will be closed automatically.

← Change your password

New password

Reenter password

Password hint

Next Cancel

7. Close the **Accounts** window.

Note:

◆ Now Windows will **not** require the password each time you launch the transceiver.

6 TECHNICAL CHARACTERISTICS

6.1 Receiver

Characteristic	Value
RX frequency range, MHz	0,09 ... 65; 95 ... 148
ADC type	LTC2209
RF ADC clock frequency, MHz	160
RF ADC resolution, bit	16
Independent software receivers	2 (+2 SubRX)
Sample rate for each receiver, kHz	39; 78; 156; 312 @ 24 bit
Sensitivity, uV	0.07
Maximum width of the Bandscope, MHz	80
Blocking Dynamic Range (BDR), dB	129
Dynamic Range over IMD3 (2 kHz), dB	>100
Reciprocal Mixing Dynamic Range (2 kHz), dB	>110
SNR, dBm	-130 (with 500 Hz bandwidth)
ENOB, bit	14
SFDR, dB	90-100 (depends on the RX frequency)
Local oscillator (TCXO), ppm	20 MHz +/- 0.5 ppm
ATT/Preamp	-20 dB; -10 dB; 0 dB; +10 dB
Additional VHF preamplifier, dB	+22

SunSDR2 PRO has a set of octave band pass filters for the HF band, narrow band pass filter for the 2M band and wide filters for entire Nyquist zones 0...65 MHz, 95...155 MHz.

9 x HF octave band pass filters:

160M: 0-2.5 MHz (Chebyshev I - 7 Order)

80M: 2.5-4 MHz (Chebyshev I - 3 Order)

60M: 4-6 MHz (Chebyshev I - 3 Order)

40M: 6-7.3 MHz (Chebyshev I - 3 Order)

30M: 7.3-12 MHz (Chebyshev I - 3 Order)

20M: 12-14.5 MHz (Chebyshev I - 3 Order)

17-15M: 14.5-21.5 MHz (Chebyshev I - 3 Order)

12-10M: 21.5-30 MHz (Chebyshev I - 3 Order)

6M: 30-65 MHz (Chebyshev I - 3 Order)

HF WideRX filter: LPF (low pass filter) 0-65 MHz (Chebyshev I - 7 Order)

Narrow band pass filter for VHF 2M: 144-148 MHz (SAW Filter) - preferred for normal operation

VHF WideRX: 95-155 MHz (Butterworth - 5 Order)

On VHF there is 1 dB attenuation in comparison to HF, which does not influence sensitivity because there an +22 dB VHF LNA.

6.2 Transmitter

Characteristic	Value
TX frequency range, M	All amateur bands (160-6; 2 M)
RF DAC clock frequency, MHz	640
RF DAC resolution, bit	14
Built-in audio DAC resolution, bit	24
Maximum output power in HF, W	100
Maximum output power in 6M and VHF, W	50
TX IMD3, dB	25-30 dB on HF/VHF bands
ATU matching band, Ohm	15-20...300-500

6.3 Internal PC

Type	Description
Motherboard	1st, 2nd batches: GIGABYTE GA-H87TN on Intel® H87 Express Chipset 3rd, 5th batches: GIGABYTE MDH11HI on Intel® H110 Express Chipset 4th batch: GIGABYTE MDH11KI on Intel® H110 Express Chipset
Processor	1st, 2nd batches: Intel® Core™ i5-4590T Processor (6M Cache, up to 3.00 GHz) Intel® HD Graphics 4600 3rd, 4th, 5th batches: Intel® Core™ i5-6400T Processor (6M Cache, up to 2.80 GHz) Intel® HD Graphics 530 Prime: Intel® Core™ i7-6700T Processor (8M Cache, up to 3.60 GHz) Intel® HD Graphics 530
RAM	1st, 2nd, 3rd, 5th batches: 8GB DDR3 - Kingston KVR16LS11/8

	4th batch: 8GB SoDDR4 - UMAX DDR4 2400 1024x8 Prime: 16GB SoDDR4 - UMAX DDR4 2400 1024x8
SSD	1st, 2nd batches: 128GB size-type mSATA 3rd, 4th, 5th batches: 120GB size-type M2 Prime: 525GB size-type M2
USB-ports	4x USB 3.0 on the transceiver's rear panel 2x USB 2.0 on the transceiver's front panel
Ports for external monitors	HDMI and DPORT
Network port	LAN 1GB
Other	COM-port

6.4 Other

Characteristic	Value
Dimensions, mm	320x140x250
Weight, kg	10
Power voltage range, V, Hz	~100 ... 240, 50-60
Maximum power consumption, W	320
Operating temperature, °C	0... +50

7 TRANSCEIVER OPERATIONS

This chapter describes all basic transceiver functionality.

7.1 Turning ON/OFF the transceiver

Before turning on the device, make sure that the power cable is connected to the AC mains and the switch on the rear panel of the transceiver is in the "I" position.

To **turn on** the transceiver, press the power button - 

A short beep will inform that the transceiver is switched on.

The transceiver will be ready for operation within approximately 30 seconds.

To **turn off** the transceiver, press and hold the power button for about 1 second - 

A short beep will inform you that the switch off process is initialized and you can release the power button.

The transceiver will turn off in approximately 5 seconds.

Note:

⚡ If for some reason the Windows OS has "frozen" and you cannot shut down the transceiver in normally, you should use the following algorithm to force a shutdown of the transceiver: press and hold the power button for about 5 seconds - 

Warning!

This applies only for the transceivers from the first and second batches (manufactured before April 2016).

- ① **We recommend to turn off the transceiver only with the  button, on the front panel of the transceiver.**
 - ① **Turn off the transceiver, by turning off Windows in the Start menu, may lead to malfunctions.**
-

7.2 Frequency Tuning

There are several ways of the **frequency tuning**:

- **Rotating the Main Knob.**

Rotate the knob clockwise to increase the tuning frequency.

Rotate the knob counter clockwise to decrease the tuning frequency.

Note:

•When the **D/I** function is **enabled** frequency tuning is carried out by moving the RX filter over the spectrum scope (stations hold their positions).

When the **D/I** function is **disabled** (by default) tuning frequency is carried out by moving the spectrum scope (filter holds its position).

To switch between DDS/IF tuning modes, press the **D/I** button on the front panel, near the Main knob.

- **Rotating the MULTI 3 knob.**

Rotate the knob clockwise to increase the tuning frequency.

Rotate the knob counter clockwise to decrease the tuning frequency.

Note:

•The **Main Knob** tunes frequency of the **VFO A** of the RX1 receiver.

The **MULTI 3** knob tunes frequency of the **VFO B** of the RX1 receiver.

•In the **A/B** mode the **Main Knob** tunes frequency of the **VFO B** of the RX1 receiver.

The **MULTI 3** knob tunes frequency of the **VFO A** of the RX1 receiver.

•In the **RX2** mode (more details in [Front Panel Description, paragraph 21](#) ¹³⁰) the **Main Knob** tunes frequency of the **VFO A** of the RX2 receiver.

The **MULTI 3** knob tunes frequency of the **VFO B** of the RX2 receiver.

•In the **RX2** mode, **A/B** mode the **Main Knob** tunes frequency of the **VFO B** of the RX2 receiver.

The **MULTI 3** knob tunes frequency of the **VFO A** of the RX2 receiver.

- **Fine tuning.**

More accurate tuning can be performed by rotating the mouse wheel with the accuracy specified in the **STEP** menu.

- **Quick tuning by the mouse click.**

On the spectrum, scope mouse cursor looks like the crosshair. Alongside this cursor displayed the exact frequency and dBm level in the certain point. The RX filter moves to this position by the click of the left mouse button.

Note:

•If the **Sub-receiver** or **SPLIT** mode is enabled, to use the **Quick tuning by the mouse click** with the **VFO A** or **VFO B** press the **mouse wheel** on the panorama. The mouse cursor color will change to match the controlled receiver - color of the mouse cursor also match the receiver's tuning line.

• Use both the **Quick tuning by the mouse click** and **Fine tuning** modes. Click on the station and perform a fine tuning with the wheel if you slightly missed.

- **Dragging the RX filter over the spectrum scope.**

Press and hold the left mouse button on the filter, then drag it left/right to the required position.

- **Moving the spectrum, the RX filter stands still.**

Press and hold the right mouse button anywhere on the spectrum, then move the spectrum, the filter will not change its position relatively to the spectrum. Tuning is carried out with the current **STEP** value.

- **Moving the spectrum, the RX filter moves along.**

Press and hold the right mouse button anywhere on the filter and move it left/right.

Note:

• Basically, this is not a way of tuning. It allows observing the air outside the panorama window, not changing the tuning frequency.

- **Click on the digit of the frequency indicator.**

Left button - increase value; right button - decrease value; wheel - all digits on the right become zero.

- **Rotate mouse wheel on the digit of the frequency indicator.**

Rotate forward - increase value; rotate backward - decrease the value.

- **Synchronous tuning by the click on the bandscope.**

Hover the mouse cursor on the required place on the bandscope and click left mouse button - RX filter will move to the required location on both bandscope and panorama.

7.3 Adjusting the AF gain

Adjust the master volume of the transceiver with the **AF** knob, on the front panel of the transceiver (marked with the red circle).

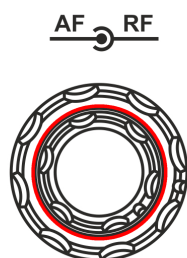

You can adjust the volume separately for each VFO, in the MIXER menu (more details in [MIXER](#)⁶²).

Note:

- Rotate the knob clockwise to increase the volume, counter clockwise to decrease the volume.
- In some cases volume might equal 0:
 CTCSS tone of the receiver' differs from the tone of the received signal - set the same tone for the receiver' as in the received signal.
- SQL threshold is higher than the received signal level - lower the **SQL** trigger threshold.
- Adjusting the volume with the **AF** knob does not apply to the volume of the internal PC (more details in [MIXER](#) ^D).

7.4 Adjusting the RF gain

Adjust the **AGC** gain by rotating the **RF** knob on the front panel of the transceiver (marked with the red circle).

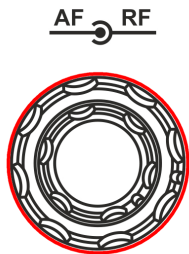

Note:

- Set the max **AGC** gain level, so that the air noise level will be minimal.
- When the **AGC** is **OFF**, the **RF** knob controls the **IF** gain.

7.5 Muting the received audio

Mute the transceiver by pressing the **MUT** button (marked with the red rectangle).
 Turn on the sound by pressing the **MUT** button again.



Note:

•Pressing **MUT** button will turn off only transceiver volume. To mute the internal PC use the special button with function 

7.6 Internal speaker On/Off

Turn on/off the **internal speaker** with the  button in the **MIXER** local panel (more details in [MIXER](#)⁶²).

Note:

- The internal speaker is active **ONLY** if the **SPEAKER** button is active in the **MIXER** menu, it doesn't matter whether you connected phones to the **PHONES** jack or not.
- The **PHONES** jack is constantly active and does not depend on the **SPEAKER** button state.

7.7 Using the Band Memory

Band buttons have 3 memory stacks.

When you press the band button, the receiver tunes on the first frequency stack.

Successive presses of the band buttons cycles through memory stacks.

Band(M)	Default (MHz) and Mode		
	Band Memory 1	Band Memory 2	Band Memory 3
160	1.81/CW	1.87/LSB	1.95/LSB
80	3.51/CW	3.65/LSB	3.7/LSB
40	7.005/CW	7.07/LSB	7.1/LSB
30	10.1/CW	10.12/CW	10.13/CW
20	14.001/CW	14.15/USB	14.2/USB
17	18.068/USB	18.1/USB	18.15/USB
15	21.001/CW	21.1/USB	21.15/USB
12	24.89/USB	24.92/USB	24.96/USB
10	28.001/CW	28.3/USB	29/NFM
6	50.001/USB	51.0/NFM	52.0/NFM
2	144.1/CW	144.5/USB	145.5/NFM

Gen	2.5/AM	5.0/AM	15.0/AM
-----	--------	--------	---------

Note:

•When you change the frequency and switch to another band, the transceiver saves the last tuned frequency in the current band memory.

7.8 Selecting the Operating Modes

Select the **Operating Mode** by pressing the **MD** or **MU** button (marked with the red rectangle) on the front panel of the transceiver.



MD - Mode Down.

Press the **MD** button to select the previous modulation type Down the list.
Press again to cycle through the modulation types.

MU - Mode Up.

Press the **MU** button to select the next modulation type Up the list.
Press again to cycle through the modulation types.

Note:

•The order of the modes list: **AM, SAM, DSB, LSB, USB, CW, NFM, WFM, SPEC, DIGL, DIGU, DRM.**

Also you can change the mode in the drop down menu.

Click on the mode type indicator on the transceiver's display (marked with the red rectangle) either with the mouse or your finger.



Select the required mode type from the drop down menu.

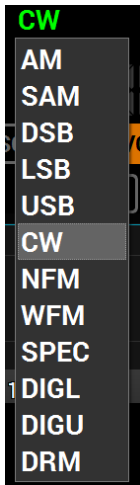

The list of the supported mode types in the MB1 transceiver (new modes may be added in the future software releases):

- **AM** - Amplitude modulation.
- **SAM** - Synchronous amplitude modulation.
- **DSB** - Double Side Band.
- **LSB** - Lower Side Band.
- **USB** - Upper Side Band.
- **CW** - CW mode.
- **NFM** - Narrow FM.
- **WFM** - Wide FM. Supports receiving of the stereo signals.
- **SPEC** - Spectrum mode.
- **DIGL** - Digital Lower Side Band (for working in digital modes).
Connect third-party software (is not supplied) to the transceiver software for working in digital modes.
- **DIGU** - Digital Upper Side Band (for working in digital modes).
Connect third-party software (is not supplied) to the transceiver software for working in digital modes.
- **DRM** - Digital Radio Mondiale, 10 kHz filter with 5 kHz IF to work with external decoder of the DRM signals.
Connect third-party software (is not supplied) to the transceiver software for decoding of the DRM signals.

Note:

•To work in digital modes use **DIGL** and **DIGU**. Mic **AGC** gain, **COMP** and **EQ** can distort the TX digital signal, that's why they are automatically disabled in this modes.

•Also in *DIGL* and *DIGU* modes you can save your TX and RX filter width.

7.9 ATT/PREAMP control

Press the **ATT** button on the front panel of the transceiver (marked with the red rectangle) to change the **attenuator** or **preamplifier** state.

Successive presses of the **ATT** button cycles coefficients in the following order: **-20dB**, **-10dB**, **0dB**, **+10dB**.

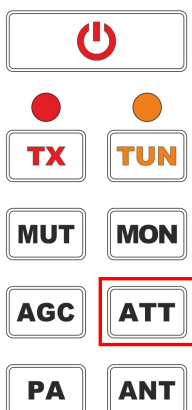

Also you can change the preamplifier state in the drop down menu.

Click on the **PRMP** indicator with the current attenuation coefficient (marked with the red rectangle) either with the mouse or your finger.

Select the required preamplifier coefficient from the drop down menu.

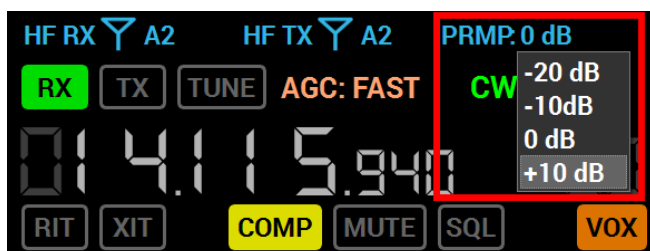

Note:

- Receive quality and overload capability of the receive path, in the presence of the powerful signals, depend on the correct attenuation coefficient of the transceiver's receive path.
- For high quality receiving, air noise should surpass the receiver's noise on 10-15 dB. Disconnect the receive antenna and make sure that the are noise level lowered on 10-15 dB to match the receiver's noise level. Lowering of the noise much lower (20-50 dB) means that you set exceedingly high receiver attenuation, it may lead to receiver's overload with powerful signals.

Receiver's overload with powerful signals results in a rapid rise of the receiver noise level over the air noise level on 20-40 dB, and rapid drop to the normal values if the cause of the overload is eliminated.

The cause of the receiver's overload may be beyond the receiver's panorama, you can find it with the help of the Band Scope.

7.10 Selecting AGC presets

The MB1's receiver has the **AGC**, which is triggered only by the received signals in the RX filter bandwidth.

For signals with different speed of rise and fall, use different **AGC** settings.

Press the **AGC** button on the front panel of the transceiver (marked with the red rectangle) to **select the required AGC preset**.

Successive presses of the **AGC** button cycles the **AGC** presets in the following order: **LONG, SLOW, MED, FAST, USER**.

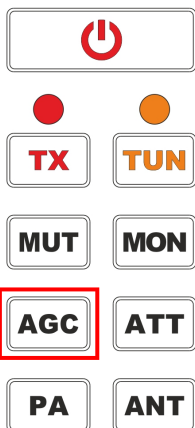

AGC presets:

- **OFF** - AGC is off.
Press and hold the **AGC** button to switch off the **AGC**.

Note:

If the **AGC** is **OFF**, **RF** knob will adjust the **IF** gain.

- **LONG** - Long AGC.
Set the **LONG** preset to use long **AGC** reaction (approximately 750 ms). Recommended for phone modes.

- **SLOW** - Slow AGC.
Set the **SLOW** preset to use slow **AGC** reaction (approximately 500 ms). Recommended for phone and digital modes.
- **MED** - Medium AGC.
Set the **MED** preset to use medium **AGC** reaction (approximately 250 ms). Recommended for CW and digital modes.
- **FAST** - Fast AGC.
Set the **FAST** preset to use fast **AGC** reaction (approximately 100 ms). Recommended for CW and digital modes.
- **USER** - Custom AGC.
Set the **USER** preset to use custom **AGC** reaction (by default the slowest 1000 ms).

Note:

• *AGC settings influence the quality of the received signal. Be careful selecting the AGC preset or tuning your own preset.*

7.11 Frequency Tuning Lock

Press the **LOCK** button on the front panel of the transceiver (marked with the red rectangle) to block **Frequency Tuning**.

LOCK - Lock button.

Press the **LOCK** button to lock the current frequency. This also blocks bands changes.

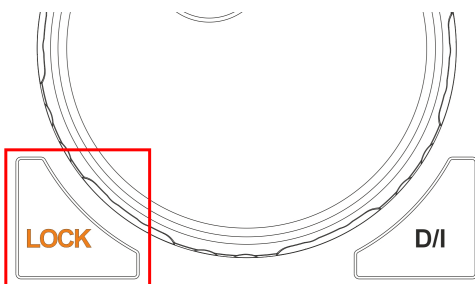

7.12 VFOA and VFOB control

Both RX1 and RX2 receiver have two tune sub-receivers VFO A and VFO B.

- The **Main Knob** controls the **VFO A** frequency of the RX1 receiver by default.
- The **MULTI 3** knob controls the **VFO B** frequency of the RX1 receiver.
To listen to the **VFO B** frequency, press the **SubRX** button on the front panel of the transceiver.

- When the **A/B** mode is enabled, the **Main Knob** controls the **VFO B** frequency of the RX1, the **MULTI 3** knob controls the **VFO A** frequency of the RX1 receiver.
Turn it on by pressing the **A/B** button on the front panel of the transceiver (marked with the red rectangle).

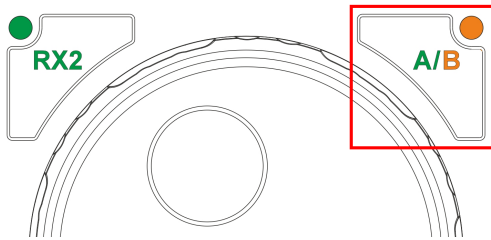

- In the **RX2** mode (more details in [Front Panel Description, paragraph 21^{D30}](#)) the **Main Knob** controls the **VFO A** frequency of the RX2 receiver.
- **MULTI 3** knob controls **VFO B** frequency of the RX2 receiver.
- In the **RX2, A/B** modes the **Main Knob** controls **VFO B** frequency of the RX2, the **MULTI 3** knob controls **VFO A** frequency of the RX2 receiver.
- If the **Sub-receiver** or **SPLIT** mode is enabled, to use the **Quick tuning by the mouse click** with the **VFO A** or **VFO B** press the **mouse wheel** on the panorama. The mouse cursor color will change to match the controlled receiver - color of the mouse cursor also match the receiver's tuning line.

VFO A and VFO B control buttons are placed on the front panel of the transceiver (marked with the red rectangle).

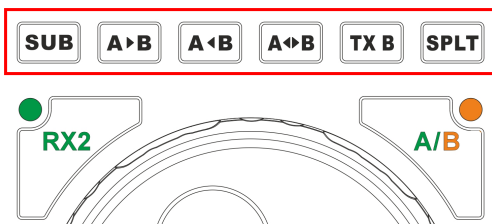

- **SUB** - Sub-receiver button.
Press the **SUB** button to enable the sub-receiver (more details in [Sub-receiver using^{D193}](#)).

Note:

• *Note! You won't hear the audio from the **VFO B** if it is out of the panorama bandwidth.*

- **A>B** - Assign the VFO A frequency to VFO B.
Press the **A>B** button to assign the frequency from the VFO A to VFO B.
- **A<B** - Assign the VFO B frequency to VFO A.
Press the **A<B** button to assign the frequency from the VFO B to VFO A.

- **A<>B** - Swap frequencies between the VFO A and VFO B.
Press the **A<>B** to exchange the frequency values between the VFO A and VFO B.
- **TX B** - Transmission from the Sub-receiver.
Press the **TX B** button to enable transmission from the Sub-receiver.
Press the **TX B** button again to return the transmission mode to VFO A.
- **SPLIT** - SPLIT button.
Press the **SPLIT** button to receive on the **VFO A** frequency and transmit on the **VFO B** frequency.
You cannot receive on the **VFO B** frequency in the **SPLIT** mode.

7.13 Changing RX Filter width by knob

Rotate the **WIDTH** knob to **change the RX Filter width**.

Rotate the **WIDTH** button clockwise to widen the filter, counter clockwise to narrow the filter.

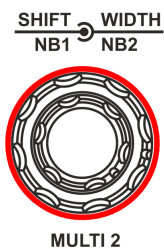

7.14 RX Filter Shifting

Rotate the **SHIFT** knob to change the **RX Filter** position (tuning frequency doesn't change).

Rotate the **SHIFT** button clockwise to shift the filter right, counter clockwise to shift the filter left.

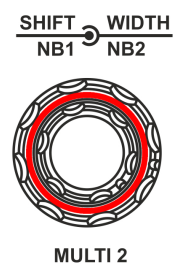

Note:

• Lower filter frequency is limited by the tuning frequency and cannot be shifted or widened beyond this limit.

7.15 Select RX Filter presets

Press the **FU** or **FD** button to switch between **RX Filter presets**.

Press the **FU** button to select a wider RX filter (Up the list).

Press the **FD** button to select a narrower RX filter (Down the list).

Note:

•*The latest in the list - the widest, is the User adjustable filter.*

Presets list depends on the mode type:

Presets for CW mode (Hz): 50, 100, 250, 400, 500, 650, 800, 1000, 1200, User.

Presets for SSB modes (LSB,USB)/DIGL/DIGU (kHz): 1.8, 2, 2.2, 2.5, 2.7, 2.9, 3.0, 3.3, 3.5, User.

Presets for AM/SAM/DSB/NFM modes (kHz): 3, 3.5, 4, 5, 6, 8, 10, 12, 16, User.

Presets for WFM mode (kHz): 150, 200, 250, 260, 270, 280, 290, 300, 310, User.

Presets for DRM mode (kHz): 10.

Presets for SPEC mode: none, because in this mode you receive the whole spectrum scope.

Note:

•*Filter Bandwidth cannot exceed the Sample Rate value set for the audio device in VAC settings.*

7.16 ZOOM-In/Out the panorama

Zoom the panorama with the Z+, Z- buttons.

Press the **Z+** button to zoom in the transceiver's panorama and more detailed signals.

Press the **Z-** button to zoom out the transceiver's panorama and see a "big picture".

The horizontal scale between the spectrum scope and waterfall shows the frequency of the certain point on the spectrum. If you move the mouse cursor over the horizontal scale a hand will appear. Press and hold the right mouse button, then move it left/right to zoom in/out the panorama or press and hold the left mouse button, then move it up/down to change the ratio of the spectrum to waterfall.

Note:

•*Zoom in/out of the panorama is carried out relative to the **Zoom position** marker, which is equal to the tuned frequency of the VFO A receiver by default, more details in [Section 7](#).⁵³*

•*You can change the Zoom position in two ways:*

- 1) *Press and hold the left mouse button on the Zoom marker and drag it left/right,*
 - 2) *Click the mouse wheel on the frequency scale.*
-

7.17 Squelch level adjusting

Rotate the **SQL** knob on the front panel of the transceiver to adjust the **Squelch trigger threshold**.

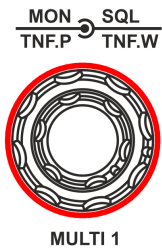

SQL threshold level displayed on the S-meter as the yellow needle. If the air signal - green needle, surpasses the **SQL** trigger threshold - yellow needle, then you'll hear the sound of the receiving station on the receiver's LF output. If the signal level is lower than the trigger threshold, you'll hear nothing.



7.18 DSP Functions

The MB1 transceiver has several Digital Signal Processing functions for improving received signals.

The list of the available DSP functions:

- **NR** - Noise reduction.
Noise Reduction, removes the white noise.
This is a special adaptive filter, which removes any abnormal noises from the air in the RX filter band.
- **NB1** - First Noise Blanker .
Noise Blanker removes impulse interference - algorithm 1.
- **NB2** - Second Noise Blanker.
Noise Blanker removes impulse interference - algorithm 2.

Note:

- *The **NB1** and **NB2** algorithms are different. Try each of them to reach the best impulse interference reduction.*
- ***NB1** and **NB2** can be used simultaneously.*

• **NB1** and **NB2** thresholds could be adjusted in the software settings (more details in [DSP tab](#) ) or with the knobs on the front panel of the transceiver.

- **ANF** - Automatic Notch Filter.

It removes the carrier signals. This is a special adaptive filter, which removes any periodical signals from the air in the RX filter band.

Note:

• If there are no interferences, **ANF** could slightly affect the reception quality. Disable the **ANF**, if you don't need it.

- **TNF** - Tuning Notch Filter. Will be available in the ExpertSDR2 1.3 Manual reject filter with adjusted rejection bandwidth.

- **BIN** - Binaural mode.

The phasing of the audio signal within the RX filter gives a stereo-like effect.

- **APF** - Analog Pick Filter.

Analog peak-filter creates the triangle filter's AFC (amplitude-frequency characteristic) in the filter bandpass.

- **DSE** - Digital Surround Effect.

Digital Surround Effect for CW signals. Provides a space orientation in stereo phones, stations from lower frequencies are louder in the left channel, stations from higher frequencies are louder in the right channel. Signal in the filter's center is equally heard in both channels of stereo phones.

This algorithm provides panorama acoustic of the CW signals in the filter bandwidth, depending on their position in the filter:

- if the received CW signal is in the receive filter bandwidth and lower the tuned frequency, it will be louder in the left phone;

- if the received CW signal is in the receive filter bandwidth and higher the tuned frequency, it will be louder in the right phone;

- if the received CW signal is in the receive filter bandwidth and in the middle of the tuned frequency, it will be equally load in both ears.

7.19 IQ files recording

IQ-files recording is required for storing the RX bandwidth panorama. Recorded file could be played later with any available mode.

IQ files are recorded on the internal SSD of the MB1.

Press the **IQ** button on the front panel of the transceiver, to start recording the IQ-file.

When the IQ-file recording starts, the **IQ** indicator is enabled (to the right of the S-Meter).

Press the **IQ** button again to stop recording.

By default IQ-files are stored over the following address: C:\Users\User_Name\ExpertSDR2\MB1\wave\

Note:

• *Q-files are stored separately for each RX1 and RX2 receiver.*

• *File name indicates - frequency and record date.*

Attention!

⚠ **Continuous recording of IQ-files, could lead to using all available free disk space on your PC!**

7.20 Frequency Tuning STEP Changing

You can change the **STEP** of the frequency tuning per one impulse of the Main Knob (1024 impulses in the full circle).

There is a **STEP** indicator in the left part of the software main window.

STEP: AUTO

The **AUTO** mode is set by default - it automatically determines the tuning **STEP** according to the speed of the Main Knob rotation.

You can change the tuning step with the **STEP** button on the front panel of the transceiver. Press the **STEP** button several times to select the required tuning step.

7.21 Antenna switch

Antenna switch operation:

The MB1 has the antenna switch, for each frequency band, antenna switch saves its own antenna input and output.

When two software receivers are active (RX1 and RX2), antenna input is the same for both receivers (because devices have one ADC), but the transceiver's antenna output may differ if software receivers work on different frequency bands.

How antenna switch works with the **RX ONLY** function:

For example: on the 80M band selected the A2 antenna output, and on the 40M band selected the A3 antenna output, if you switch from the 40M band to the 80M band, you'll be able to

assign the **RX ONLY** on the A3 antenna output and lock it only for RX. Now if you switch one of the software receivers on the 40M band, the transceiver's antenna switch will detect that the A3 output is locked for RX and won't change it (leave it in a state before switching to the 40M band).

To assign the **RX ONLY** on an antenna input it's required to have at least one free antenna input, e.g. all software receivers should have another antenna output for TX.

"**Save per band**" function in the Antenna switch can be turned off in the drop-down menu. When it's disabled, transmitter output will switch for both software RXs on all bands.

If you have the ATU unit, you don't have to re-tune it for each band. Because tuner's memory depends on the frequency, not antenna output.

ADC - connector is the direct input, bypassing Band Pass Filters (BPFs). ADC connector may be used for connection of the receiving antennas, transverters, additional BPFs, preamplifiers, attenuators etc.

Note:

•*The signal from ADC IN connector goes to the ADC input and may be amplified by the preamplifier +10dB if it will be chosen in the software.*

Warning! Maximum allowed signal level on the ADC IN connector is 0.3V of the active voltage (RMS). Do not exceed it, it may result in the transceivers overload and ADC fatal damage.

DAC OUT - is the transceiver's low-power output, works in the wide frequency band.

Note:

•*The output can be used for connection of external power amplifiers, transverters and as a generator of the measuring signal.*

•*Transmission is possible only on the amateur bands.*

Antenna switching with the **F1-F10 functional buttons** on the front panel of the transceiver. Set any function **RX ANT**, **TX ANT**, **RX A1...RX A4** from the pop-up menu, for the **F1-F10 functional buttons** (more details in [Functional buttons using \$\square^{183}\$](#)).

7.22 Functional buttons using

MB1 transceiver functional buttons widen the control capability and make the overall usage more comfortable.

The transceiver has two groups of the functional buttons:

- **F1-F10** - functional buttons on the front panel of the transceiver.
- **F11-F21** - functional buttons on the front panel above the offset button (will be active in later software releases).

To assign a function for the F1-F10 buttons, click left mouse button (or with your finger via the touch-screen) on the sign over the button. In the appeared list select the required function (see the picture below).

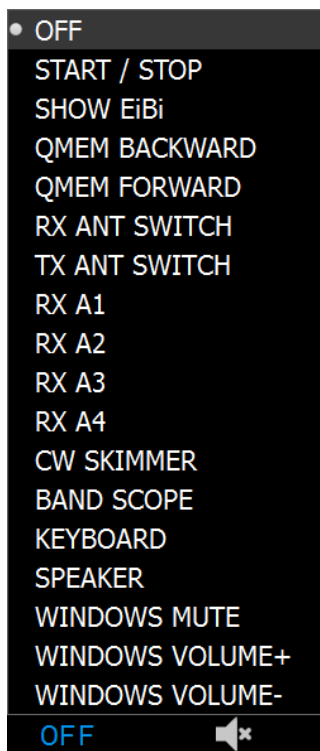

Assigned function will be displayed over the functional button.

The list of the available functions (new functions may be added in future software releases):

- **OFF** - Nothing is assigned.
- **START/STOP** - START/STOP RX mode.
- **SHOW EIBi** - Show the HF stations markers on the panorama from the EIBi data basis.
- **QMEM BACKWARD** - Backward frequency from the quick memory.
Press the **QMEM BACKWARD** button to go to the previous frequency (memorize last 16 frequencies. Frequency is memorized in 2 seconds).
- **QMEM FORWARD** - Forward frequency from the quick memory.
Press the **QMEM FORWARD** button to go to the next frequency (works if earlier you switched backward from another frequency).

- **RX ANT SWITCH** - Switch to the next RX antenna in the list.
- **TX ANT SWITCH** - Switch to the next TX antenna in the list.
- **RX ONLY A1** - Select the RX A1 antenna as **RX ONLY**.
Used for HF and VHF bands.
- **RX ONLY A2** - Select the RX A2 antenna as **RX ONLY**.
Used for HF and VHF bands.
- **RX ONLY A3** - Select the RX A3 antenna as **RX ONLY**.
- **RX ONLY A4** - Select the RX A4 antenna as **RX ONLY**.
- **CW SKIMMER** - Make a connection with the CW Skimmer.
- **BAND SCOPE** - Enable the Band-Scope with 80 MHz band.
- **KEYBOARD** - Enable the digital Windows keyboard.
- **SPEAKER** - Enable/disable the internal speaker.
- **WINDOWS MUTE** - Disable the sound from the internal PC.
- **WINDOWS VOLUME+** - Increase the volume from the internal PC.
- **WINDOWS VOLUME-** - Decrease the volume from the internal PC.

7.23 DRIVE level adjusting

Rotate the **DRIVE** knob on the front panel of the MB1 transceiver, to adjust the output power level.



DRIVE - Drive knob.

Rotate the **DRIVE** knob clockwise to increase the output power, counter clockwise to decrease the output power.

The output power level displayed in % in the software Main window, on the **PWR: XX%** indicator.

Note:

- *By default, the output power is stored for each band.*
 - *The output power % value, doesn't always mean the same in Watt, may vary.*
-

7.24 Microphone gain control

Rotate the **MIC** knob on the front panel of the MB1 to adjust the **Microphone gain**, it determines the **max** coefficient of the microphone AGC gain.



MIC - MIC AGC knob (in dB).

Rotate the **MIC** knob clockwise to increase microphone AGC gain, counter clockwise to decrease microphone AGC gain.

The microphone gain level is displayed in the software Main window.

Note:

- Set the MIC AGC gain, that the microphone signal is increased to the level of -10...-5 dB on the MIC-meter indicator (green bar).
 - When the **MIC AGC** is disabled in the MIC/CW local panel, the **MIC** knob sets the actual gain.
 - In the phone modes - knob controls microphone gain, in the CW mode - knob controls the manipulation speed.
-

Mic Gain and Compression settings:

1. Set the Meter to the Mic-meter mode in the Desktop style (right click on the S-Meter->TX->Mic-meter).
2. Set the Drive level to 0.
3. Enable the TX mode and speak in the microphone.
4. Increase the Mic gain from 0 dB till the Mic meter readings will reach -10...-5 dB in peaks.
5. If required enable the compressor.
6. Set Compression to 2-5; set COMP threshold to \sim -30 dB. This level should be more than room noises for about 10-15 dB.

7.25 TX Monitoring Gain

TX Monitoring allows you to listen to the TX signal and control its quality.

Press the **MON** button on the transceiver's front panel to enable the **TX Monitoring Gain**. Rotate the **MON** knob to change the monitoring volume in the TX mode.



Note:

- The **MON** knob will be active only in the TX mode with pressed **MON** button.
- Excessive monitoring volume may lead to the positive acoustic connection between the microphone and headphones (internal dynamic) and as a result to the self-triggering of the TX path.

7.26 Voice Recorder Operation

Voice recorder records the signal in the RX filter and the signal of your own microphone in the TX mode.



Record of the receive voice signal:

1. Press the **Rec** button  on the front panel of the transceiver to start recording. The red LED indicator on the left of the **Rec** button will start blinking.
2. Press again the **Rec** button  on the front panel of the transceiver to stop recording. The red LED indicator will stop blinking.

Note:

- Recording of the received signal is available in all mode types.

Record of the microphone signal:

1. Press the **PTT** button on the microphone or the **TX** button on the front panel of the transceiver. Transceiver will turn to the TX mode.
2. Press the **Rec** button  on the front panel of the transceiver to start recording and begin to speak in the microphone. The red LED indicator will start blinking.
3. Press again the **Rec** button  on the front panel of the transceiver to stop the recording. The red LED indicator will stop blinking.

Play the recorded signal without transmitting it on the air:

1. **Press and hold** (~1 sec) the **Play** button  on the front panel of the transceiver to play the recorded voice signal in phones or internal speaker. In the meantime the receiver will be silent.
2. When the playback ends you'll hear the air again.

Play the recorded signal with transmitting it on the air:

1. **Short press** the **Play** button  on the front panel of the transceiver to play the recorded voice signal in phones or internal speaker and transmit it on the air.
2. When the playback ends you'll hear the air again.

Note:

•If a recorded signal, which was received from the air, wasn't compressed by the transmitter, it has low RMS power - lower, than compressed signal. Voice recorder has its own AGC, it doesn't allow TX signal level to surpass the maximum threshold, to avoid clipping. This AGC has maximum amplitude threshold for audio signal output: +3 dB, it allows an operator to hear slight clipping with a high gain level of voice recorder signal and adjust correct **Volume for TX** coefficient, keeping a good quality of TX signal. The Peak level set in ExpertSDR2 is 0 dB. The RMS signal level is 3 times weaker by amplitude than peak level. TX signal, recorded by the Voice Recorder, is transmitted on the air without processing e.g. TX processing module does not influence signal transmitted via the Voice Recorder.

•Attention, recordings of the air signals should be used for personal use only. MB1 operator bears full responsibility for using the recorded signal.

•You may record your own CQ (come quick) signal and transmit it on the air by pressing the **Play** button 

7.27 Transverter mode operation

Will be available in ExpertSDR2 1.3.

7.28 Transmitting in CW mode

1. Connect the CW key to the transceiver.
2. Set the CW mode type.
3. Enable the **BREAK-IN** mode on the local panel [MIC/CW SETTINGS](#)⁶⁰.
4. Use the CW key.

Note:

•When you transmit in the CW mode - red TX indicator is flashing.

•In CW mode, transceiver always generates monitoring signal, even if the **MON** button is not pressed, you use it while working on the air. BUT, if the **MON** button is not pressed, TX signal won't be displayed on the panorama. To display your TX CW signal press the **MON** button (see [Global controls panel](#) ⁶⁶).

7.29 Transmitting in Voice mode

1. Press the **PTT** button on the microphone or the **TX** button on the front panel of the transceiver.
2. Speak in the microphone in a calm tone.
3. Release the **PTT** button on the microphone or press again the **TX** button on the front panel of the transceiver.

Note:

•You may turn to TX by pressing the PTT footswitch, connected to the PTT connector on the rear panel of the transceiver (more details in [Accessories](#) ⁹). Release the footswitch to stop transmission and return to the RX mode.

7.30 DAC OUT operation

DAC OUT is the transceiver's low-power output, for experimental purposes.

1. To work with the DAC OUT press the **DAC OUT** button in the local panel of the HF path.
2. Tune on the required frequency.
3. Enable the TX mode by pressing the **PTT** button on the Mic or the **TX** button.

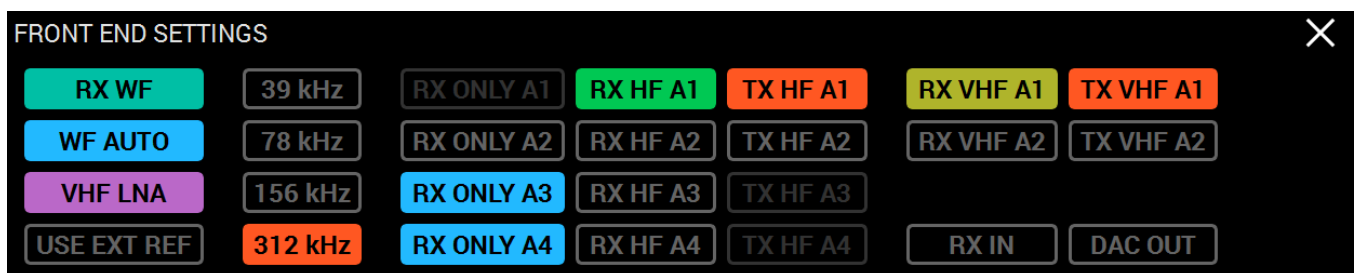

Note:

- The output can be used for connection of the external power amplifiers, transverters and as a generator of the measuring signal.
- Transmission is allowed only on the amateur bands.

7.31 CTCSS Tones using

In some cases it's required to activate the squelch with the **CTCSS** tones.

To operate in the **CTCSS** mode:

1. Set the **NFM** mode.
2. Press and hold the **MD** or **MU** button to open the **NFM** local panel and set the receiver's tone frequency with the **RX TONE** slider or enter the required number from the keyboard in the **RX TONE** input box (if required).
 - 2.a. Open the **NFM** local panel and set the transceiver's tone frequency with the **TX TONE** slider or enter the required number from the keyboard in the **TX TONE** input box (if required).
3. Press one of the buttons **RX/TX**, **RX ONLY**, **TX ONLY**:
RX/TX - CTCSS mode is active in RX and TX modes.
RX ONLY - CTCSS mode is active in RX mode.
TX ONLY - CTCSS mode is active in TX mode.
4. Set (if required) the tone level.
By default 15% - common value for this mode.
5. Press the **CTCSS** button to activate the CTCSS mode.
6. Receive signals with the CTCSS tone.
 - 6.a. Press the **PTT** button on the Mic or the **TX** button on the front panel of the transceiver to transmit the signals with the CTCSS tone.
7. Release the **PTT** button on the Mic or press the **TX** button again to turn back to the RX mode.

7.32 Burst Tone using

In some cases repeater stops working after some time - goes to "sleep" mode.

To wake it from the "sleep" mode you need to send the Burst tone of the exact frequency for some time.

To form a Burst tone:

1. Set the **NFM** mode.
2. Press and hold the **MD** or **MU** button to open the **NFM** local panel and set the tone frequency with the **FREQUENCY** slider or enter the required number from the keyboard.
Common value for the tone frequency **1750 Hz**, but can vary in some repeaters.
3. Set the required tone TX time, enough for the used repeater, with the **TIMEOUT** slider or enter the required number from the keyboard.

4. Press the **BURST TONE** button.

The transceiver will send the FM tone signal with your presets.

7.33 Bandscope operation

Here is the way the **Bandscope** window looks like.

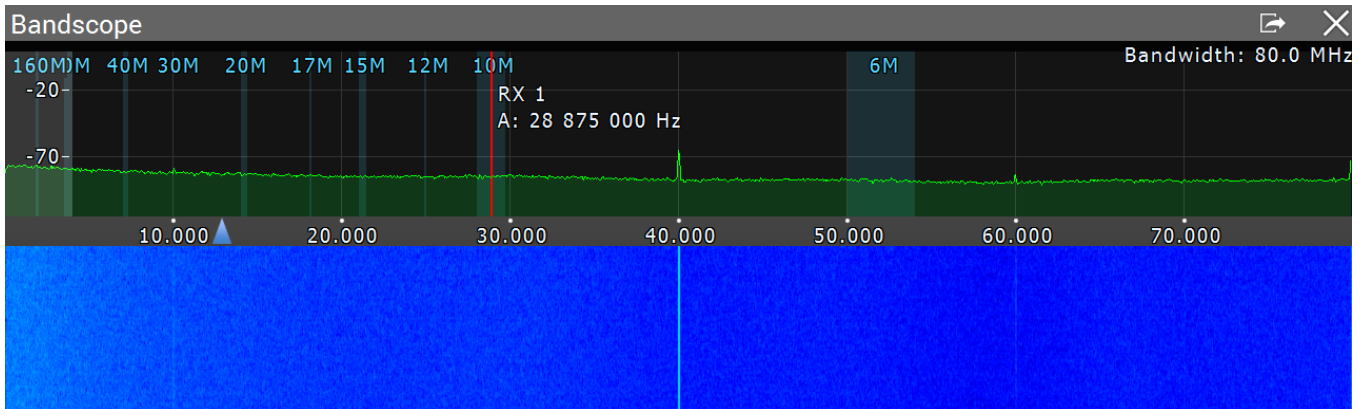

To open the **Bandscope** window assign the BANDSCOPE (**BS**) function on one of the functional buttons and press it.

Press and hold the **BS** button, the **IND 2** indicator will turn **blue**, now you can control the Bandscope window with **MULTI 1,2,3** knobs:

Rotate the **MULTI 1** thick part to change the spectrum level.

Rotate the **MULTI 1** thin part to change the spectrum dBm scaling.

Rotate the **MULTI 2** thick part to zoom in/out the bandscope.

Rotate the **MULTI 2** thin part to change position of the zoom triangle.

Rotate the **MULTI 3** knob to move left/right the panorama.

When you use the **bandscope**, Band Pass Filters are still active, to use the WideRX filter (0-65 MHz or 95-155 MHz), set the **Use wide RX filter** checkbox or **Auto enable** checkbox (it will turn the Wide RX filter automatically) in the Options > [Device menu](#)⁹⁴.

8 SPLIT OPERATION

SPLIT operation allows you to receive on the VFO A frequency and transmit on the VFO B frequency.

You cannot receive on the VFO B frequency in the **SPLIT** mode.

To use the **SPLIT** operation:

1. **Activate the SPLIT mode** by pressing the **SPLIT** button, on the front panel of the transceiver.

Flashing **SPLIT** indicator in the software window means the **SPLIT** mode is enabled.

2. Set the required transmit frequency (VFO B) in the **SPLIT** mode (more details in [VFO A and VFO B control](#)¹⁷⁶).

3. Press the microphone PTT button or the TX button on the the front panel of the transceiver to transmit.
4. Release the microphone PTT button or press again the TX button on the the front panel of the transceiver to turn to the RX mode.

Disable the SPLIT mode by pressing the **SPLIT** button again.

Note:

- While you are in **CW** mode with **BREAK IN** function enabled, the transceiver will turn to TX on VFO B frequency automatically when pressing the CW key.
 - While in **digital modes** the transceiver will turn to TX on VFO B frequency automatically if received the PTT signal via the CAT-system or a certain COM-port.
-

8.1 SPLIT + Sub RX Operation

In some cases, you need to transmit in a SPLIT mode and simultaneously listen to the transmit frequency (VFO B), in other words, use Sub-receiver.

To enable this mode:

1. **Activate the SPLIT mode** by pressing the **SPLIT** button, on the front panel of the transceiver.
Flashing **SPLIT** indicator in the software window means the **SPLIT** mode is enabled.
 2. **Activate the Sub-receiver** by pressing the **SUB** button, on the front panel of the transceiver.
Flashing **Sub RX** indicator in the software window means the Sub-receiver is enabled.
 3. Set the required transmit frequency (VFO B) (more details in [VFO A and VFO B control](#)¹⁷⁶).
 4. Listen to the VFO A and VFO B frequencies simultaneously. If you need to adjust the Volume and Balance of each VFO A and VFO B, more details in [MIXER](#)⁶².
 5. Press the microphone PTT button or the TX button on the the front panel of the transceiver to transmit.
 6. Release the microphone PTT button or press again the TX button on the the front panel of the transceiver to turn to RX mode.
-

Note:

- Sub-receiver's red tuning line means that you'll transmit on the VFO B frequency.
 - You can switch the TX status between VFO A and VFO B by pressing the RX indicator near any VFO tuned frequency.
-

9 SUB RECEIVER USING

If you want to listen the VFO A and VFO B frequencies simultaneously, use Sub-receiver.

1. **Activate Sub-receiver** by pressing the **SUB** button, on the front panel of the transceiver. Flashing **Sub RX** indicator in the software window means the Sub-receiver is enabled.
2. Set the required VFO B frequency (more details in [VFO A and VFO B control](#)¹⁷⁶).
3. Listen to the VFO A and VFO B frequencies simultaneously. If you need to adjust the Volume and Balance of each VFO A and VFO B (more details in [MIXER](#)⁶²).

Note:

- VFO A receiver's red tuning line means that in **Sub-RX** mode you'll transmit on the VFO A frequency.
 - To turn the Sub-receiver to transmit, press **TX B** or **SPLIT**.
 - You can switch the **point and click** control on the panorama between VFO A and VFO B receivers, by pressing the middle mouse button. You'll control the RX with the same color to the mouse cursor.
 - When you change the band the SubRX is disabled.
-

10 RIT/XIT OPERATIONS

Sometimes you need to use RIT/XIT modes.

10.1 RIT

The **RIT** offset in the RX mode means that transmission will be held on the tuned frequency and receiving frequency will differ by the offset value.

The offset is displayed as a translucent band on the spectrum scope.

Tuned TX frequency displayed as the red line. RX frequency displayed as the green line with the filter band (on the picture you can see USB mode).

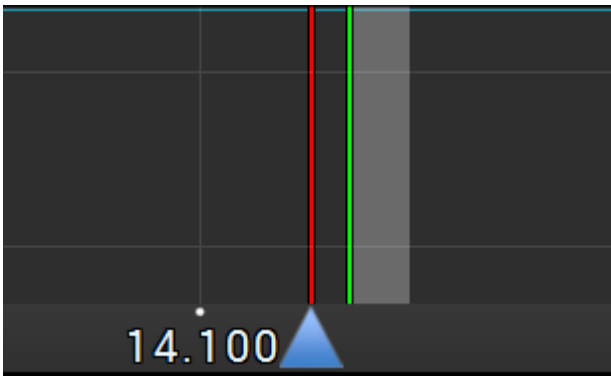

To activate the RIT mode:

1. Press the **RIT** button on the front panel of the transceiver.
Green indicator under the **RIT** button signals that the mode is active.
2. Rotate the **Multi 3** knob to set the required offset.

Press and hold the **RIT** button for about 0.5-0.8 sec **to nullify the offset.**

To disable RIT - press the **RIT** button again.

Idle green indicator under the **RIT** button signals that the mode is disabled.

Note:

*•If the **RIT** offset wasn't reset, when you disable the **RIT** its state will be saved. When you activate the **RIT** next time, the offset will equal the previous value.*

You may enter the frequency offset value in the input box via keypad (in **Desktop** mode), or by clicking on the required frequency on the spectrum scope. At the same time the following values will be displayed below the main receiver's frequency indicator:

RIT: - the frequency offset.

L: and **H:** - low and high filter's edges frequencies.

O: - mouse cursor frequency inside the filter.

To change the filter bandwidth: move the mouse cursor over the filter edge, it will be highlighted, then drag the edge with the left mouse button.

When the **RIT** is enabled, frequency tuning changes a bit:

Press and hold the left mouse button inside the RX filter to move it over the panorama.

Press and hold the left right button inside the RX filter to move the whole panorama with the filter.

Press and hold the middle mouse button inside the RX filter then move the mouse cursor out of the filter bandwidth, the **O:** indicator will show the frequency difference between the mouse cursor and the RX filter.

10.2 XIT

The **XIT** offset in the TX mode means that receiving will be held on the tuned frequency and transmission frequency will differ by the offset value.

Offset is displayed as a translucent band on the spectrum scope.

RX frequency displayed as the tuned receiver's frequency - green line.

TX frequency displayed as the tuned transceiver's frequency - red line with the filter band (on the picture below you can see USB mode).

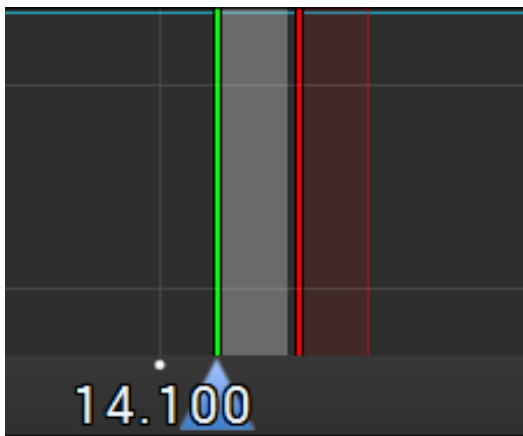

To activate the XIT mode:

1. Short press the **XIT** button on the front panel of the transceiver..
Orange indicator over the **XIT** button signals that the mode is active.
2. Rotate the **Multi 3** knob to set the required offset.

Press and hold the **XIT** button for about 0.5-0.8 sec **to return the offset to zero.**

To disable XIT - short press the **XIT** button again.

Idle orange indicator over the **XIT** button signals that the mode is disabled.

Note:

•If the **XIT offset wasn't reset**, then if you disable the **XIT** it's state will be saved. When you'll activate the **XIT** next time, transceiver will set the offset according to the previous value.

11 SHIFT BUTTONS OPERATION

The **SHIFT** mode allows to enable secondary functions of the front panel buttons.

Press and hold the **SHIFT** button for about 0.5-0.8 sec to enable the **SHIFT** mode - secondary functions of the front panel buttons. Orange **SHIFT** indicator on the transceiver's front panel indicates that the **SHIFT** mode is active.

12 DIGITAL MODES OPERATION

The MB1 transceiver allows you to operate in digital modes with the help of the certain programs (which are not provided by the manufacturer).

Note:

•More information about the MB1 with the digital modes and popular programs will be explained in the new version of the User Manual.

13 RX2 OPERATION

The MB1 transceiver has the second software receiver **RX2**, with the panorama up to 312 kHz and two independent Sub-receivers VFO A and VFO B.

The **RX2** may receive on any band in the same Nyquist zone as the **RX1**, in other words **RX1** and **RX2** may simultaneously receive in 0...80 MHz or 80-160 MHz. **RX2** has independent controls and indicators.

RX2 receiver displayed in the separate window and requires additional external display for comfortable operation.

To enable the **RX2** receiver - press the **RX2** button on the front panel of the transceiver.

How to control the tuning of the **RX2** receiver you may read here [Frequency tuning](#).^{D167}

Note:

•The **RX2** window has a Desktop design.
